

lightnet

Highlighting
Architecture



Collection XXII

Update 11.2022 DE/EN

Überblick Overview	2
Nachhaltigkeit Sustainability	10
Stromschiene Track	26
Tisch Table	50
Steh Floor	66
Wand Wall	120
Pendel Suspended	170
Anbau Surface	332
Einbau Recessed	430
Höhere Schutzart Higher Protection	510
Appendix	525

Stromschiene | Track



Midpin C2/C3 |
48V Track
30



Midpoint C6 |
3-Phase Track
34



Midpoint C7 |
3-Phase DALI Track
36



Grand Lucille S9 |
Floor
70



Lucille S1 |
Floor
74



Basic Déco C3 |
3-Phase Track
38



Liquid Line Compact C5 |
3-Phase Track
40



Liquid Line CX | System
40mm 3-Phase Track
42



Beam Me Up S4 |
Floor
88



Beam Me Up S6 |
Floor
90



Cubic Evolution C4 |
3-Phase Track
44



Matric Déco C9 |
System 55mm 3-Phase Track
46



3-Phase Track
48

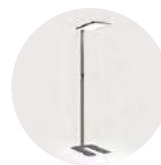

Cubic Evolution F2 |
Floor
106



Cubic Evolution F3 |
Floor
108

Tisch | Table



Lucille T1 |
Table
54



Beam Me Up T1 |
Mini Table Office
56

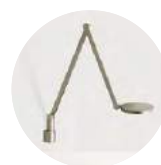

Lucille W1 |
Wall
124

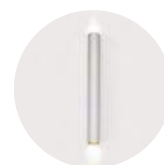

Midpin W2 |
Wall
126



Beam Me Up T2 |
Mini Table Home
58



Cubic Evolution
T2/T3 | Table
60



Basic Visio Y9/X9 |
Wall
138



Liquid Line Compact
W5 | Wall
140



Liquid Line TY | System
40mm Table Symmetric
62



Liquid Line TX | System
40mm Table Asymmetric
64



Cubic Ambient A7 |
Wall
154



Matric Ambient AX |
System 40mm Wall
158

Steh | Floor



Basic Neo S2 |
Floor
78



Basic Neo S4 |
Floor
80



Basic Déco S3 |
Floor
82



Basic Déco S5 |
Floor
84



Beam Me Up S1 |
Mini Floor
86



Liquid Line SX | System
40mm Floor One Head
92



Liquid Line SY | System
40mm Floor Two Heads
94



Caleo Neo S2 |
Floor
96



Caleo Neo S4 |
Floor
98



Cubic Evolution F1 |
Floor
104



Cubic Evolution F5/F6 |
Floor
110



Cubic Evolution F7 |
Floor
112



Cubic Evolution F8 |
Floor
114

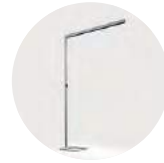

Matric SX | System
40mm Floor One Head
116



Matric SY | System 40mm
Floor Two Heads
118

Wand | Wall



Midpoint W7 |
Wall
128



Basic Superflat X7/Y7 |
Wall
130



Basic Neo W5 |
Wall
132



Basic Neo Y5/X5 |
Wall
134



Basic Déco Y3/X3 |
Wall
136



Liquid Line WX |
System 40mm Wall
142



Caleo Neo Y6/X6 |
Wall
144



Cubic Evolution W4 |
Wall
148



Cubic Evolution Y6/X6 |
Wall
150



Cubic Déco A3 |
Wall
152



Matric WX |
System 40mm Wall
160



Matric DX |
System 40mm Wall
162



Matric JX |
System 40mm Wall
164



Matric W4 |
System 55mm Wall
166



Matric W6 |
System 81mm Wall
168

Pendel | Suspended



Midpin G3 |
Single Suspended
174



Midpoint P7/P8 |
Suspended
176



Basic Max G1/P1 |
Suspended
196



Basic Visio G9/P9 |
Suspended
198



Ringo Star Acoustic GY/PY |
System 40mm Suspended
214



Ringo Star G3/P3 |
System 60mm Suspended
222



Ringo Star Chain G3/P3 |
Suspended
242



Ringo Star Oblong
GX/PX | Suspended
244



Caleo Neo G4/P4 |
Suspended
276



Caleo Neo G6/P6 |
Suspended
280

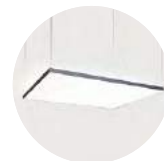

Cubic Max G2/P2 |
Suspended
294

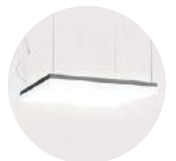

Cubic Ambient G7/P7 |
Suspended
296



Matric R4 | System
55mm Suspended
314



Matric G5 | System
81mm Suspended
316



Basic Superflat G7/P7 |
Suspended
180



Basic Neo G5/P5 |
Suspended
184



Basic Déco G3/P3 |
Suspended
188



Basic Déco XXL G4/P4 |
Suspended
190



Basic Déco O3 |
Suspended
192



Beam Me Up (Flat)
G3/P3 | Suspended
202



Beam Me Up (Max)
G1/P1 | Suspended
206



Ringo Star Compact
G5/P5 | Suspended
208



Ringo Star GY/PY |
System 40mm Suspended
210

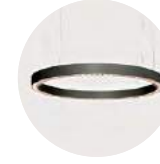

Ringo Star GX/PX |
System 40mm Suspended
212



Ringo Star Acoustic G3/P3 |
System 60mm Suspended
224



Ringo Star G1/P1 |
System 100mm Suspended
226



Ringo Star Acoustic G1/P1 |
System 100mm Suspended
228



Ringo Star Chandelier
G1/P1 | Suspended
232



Ringo Star Cluster G3/P3 |
Suspended
240

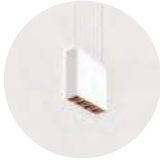

Liquid Line Compact
G5/P5 | Suspended
246



Liquid Line GX/PX |
System 40mm Suspended
248



Liquid Line G3/P3 |
System 60mm Suspended
264



Code Zero G3/P3 |
Suspended
272



Caleo Inverse GX/PX |
System 40mm Suspended
274



Cubic Evolution G4/P4 |
200mm Suspended
284



Cubic Evolution G5/P5 |
300mm Suspended
286



Cubic Evolution G6/P6 |
Square Suspended
288



Cubic Evolution G4/P4 |
System Suspended
290

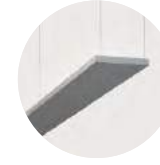

Cubic Evolution U4 |
Suspended
292



Cubic Déco G3/P3 |
Suspended
298



Matric Déco G9/R9 |
Suspended
300



Matric RY | System 40mm
Suspended
308



Matric GX/RX | System
40mm Suspended
310



Matric G3/R3 | System
55mm Suspended
312



Matric G6/R6 | System
81mm Suspended
318



Matric Square GX/RX |
System 40mm Suspended
322



Matric Square Acoustic GX/RX |
System 40mm Suspended
326



Vision Gen. 4 G4/P4 |
Suspended
328



Plank G4/P4 |
Suspended
330

Anbau | Surface



Midpoint B7 |
Surface
334



Midpoint A6 |
Surface
336



Basic Déco Z3 |
Surface
350



Basic Max A1 |
Surface
352



Ringo Star Compact A5 |
Surface
366



Ringo Star AX | System
40mm Surface
368



Caleo Inverse AX |
System 40mm Surface
386



Caleo Neo Y4/X4 |
200mm Surface
388



Cubic Max A2/X2 |
Surface
400



Cubic Ambient A7 |
Surface
402



Matric A3 | System
55mm Surface
420



Matric A5 | System
81mm Surface
422



Basic Superflat Y7/X7 |
Surface
338



Basic Neo A5 |
Surface
342



Basic Neo X5 |
Surface
344



Basic Déco A3/A4 |
Surface
346



Basic Déco X3 |
Surface
348



Basic Max Y1/X1 |
Surface
354



Basic Visio Y9/X9 |
Surface
356



Beam Me Up (Flat)
Y3/X3 | Surface
358



Beam Me Up (Max)
Y1/X1 | Surface
362



Beam Me Up (Wallwasher)
A4 | Surface
364



Ringo Star A3 | System
60mm Surface
370



Ringo Star A1 | System
100mm Surface
372

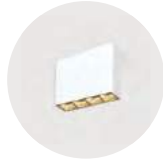

Liquid Line Compact
A5 | Surface
374



Liquid Line AX | System
40mm Surface
376



Liquid Line A3 | System
60mm Surface
382



Caleo Neo Y6/X6 |
Square Surface
390



Cubic Evolution Y4/X4 |
200mm Surface
392



Cubic Evolution Y5/X5 |
300mm Surface
394



Cubic Evolution Y6/X6 |
Square Surface
396



Cubic Neo A9 |
Surface
398



Cubic Déco A3 |
Surface
404



Matric Déco A9 |
Surface
406



Matric AY | System
40mm Surface
408

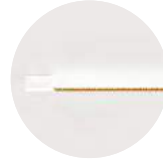

Matric XY | System
40mm Surface
410

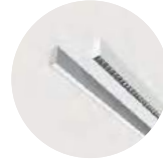

Matric AX | System
40mm Surface
418

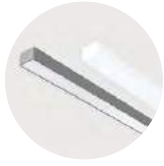

Matric A6 | System
81mm Surface
424



Vision Gen. 4 A4/X4 |
Surface
426



Plank Y4/X4 |
Surface
428

Einbau | Recessed



Midpin M2 |
Recessed
432



Midpoint E6 |
Semi-Recessed
436

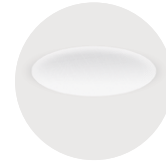

Basic Max M2 |
Recessed Frameless
450



Basic Max M4 |
Recessed Frame
452



Liquid Line QX/FX |
System 40mm Recessed
466



Liquid Line F3 | System
60mm Recessed
474



Matric Déco M9 |
Recessed Frameless
488



Matric Déco F9 |
Recessed Frame
490



Matric F5 | System
81mm Recessed Frame
508

Höhere Schutzart | Higher



Basic Max A1 IP54 |
Surface
512



Matric AX IP54 |
System 40mm Surface
516

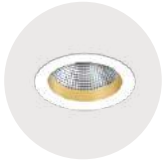

Midpoint F7 |
Recessed
438



Midpoint M6 |
Recessed
440



Basic Superflat L7 |
Semi-Recessed
442



Basic Déco N3 |
Recessed Frameless
444



Basic Déco L3 |
Recessed Frame
446



Basic Visio L9 |
Semi-Recessed
454



Ringo Star Compact F5 |
Recessed Frame
456



Ringo Star FX | System
40mm Recessed Frame
458

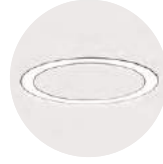

Ringo Star F1 | System
100mm Recessed Frame
462

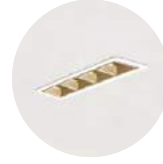

Liquid Line Compact F5 |
Recessed Frame
464



Caleo Max M2 |
Recessed Frameless
478



Cubic Max M2 |
Recessed Frameless
480



Cubic Max M4 |
Recessed Frame
482



Cubic Ambient M7 |
Recessed Frame
484



Cubic Déco L3 |
Recessed Frame
486



Matric MX | System 40mm
Recessed Frameless
498



Matric FX | System
40mm Recessed Frame
500



Matric M3 | System
55mm Recessed Frameless
502



Matric F3 | System
55mm Recessed Frame
504



Matric M5 | System 81mm
Recessed Frameless
506

Protection



Matric A3 IP54 |
System 55mm Surface
518



Matric FX IP54 | System
40mm Recessed Frame
520



Matric F3 IP54 | System
55mm Recessed Frame
522

Sustainability

Welcome to
Lightnet



Lightnet - Licht ist (unser) Leben

Lightnet verbindet Architektur und Licht auf ästhetische Weise und macht das Leben damit jeden Tag ein wenig schöner. Weil wir das Leben aber auch schützen möchten, agieren wir nachhaltig und ressourcenschonend, entwickeln unsere eigene LED-Technologie und erfinden uns jeden Tag neu. Mit kreativen Ideen von über 500 Kollegen an sechs Standorten weltweit.

Lightnet - Light is (our) life

Lightnet combines architecture and light in an aesthetic way, making life a little more beautiful every day. We also want to protect life, we act sustainably and conserve resources, develop our own LED technology and reinvent ourselves every day. With creative ideas from over 500 colleagues at six locations worldwide.



Wir produzieren zu 100% selbst

Bauteile um die halbe Welt zu transportieren schadet der Umwelt und ist nicht mehr zeitgemäß. Deshalb produzieren wir alle Produkte selbst. In unserer Fabrik stellen wir Rohplatinen, Optikbauteile und mechanische Gehäuse her, machen aber auch das Oberflächenfinish und die Endmontage. Wir kontrollieren die gesamte Wertschöpfungskette und wissen von der Entwicklung bis zum Recycling genau, was wir tun. So arbeiten wir nachhaltig und können uns in jedem Aspekt ständig weiterentwickeln.

In-House-Production
100%

We produce 100% ourselves

Transporting components halfway around the world harms the environment and is no longer state of the art. That's why we manufacture all our products ourselves. In our factory we produce raw boards, optical components and mechanical housings, but we also do the surface finishing and final assembly. We control the entire value chain and know exactly what we are doing, from development to recycling. In this way, we work sustainably and are able to develop ourselves continuously in every aspect.



Die Nachfrage bestimmt das Angebot

Wir produzieren nur, was wirklich gebraucht wird. So sparen wir wertvolle Ressourcen bei Produktion, Lagerung und Entsorgung, agieren nachhaltig und im Sinne der Industrie 4.0. Der Kunde steht dabei immer im Mittelpunkt, denn dank unserer intelligent-vernetzten Technologie kann er jede Produkteigenschaft selbst konfigurieren.

Demand determines supply

We only produce what is really needed. In this way, we save valuable resources in production, storage and disposal, act sustainably and in the spirit of Industry 4.0. The customer is always our focus, and thanks to our intelligent networked technology, they can configure every product feature themselves.

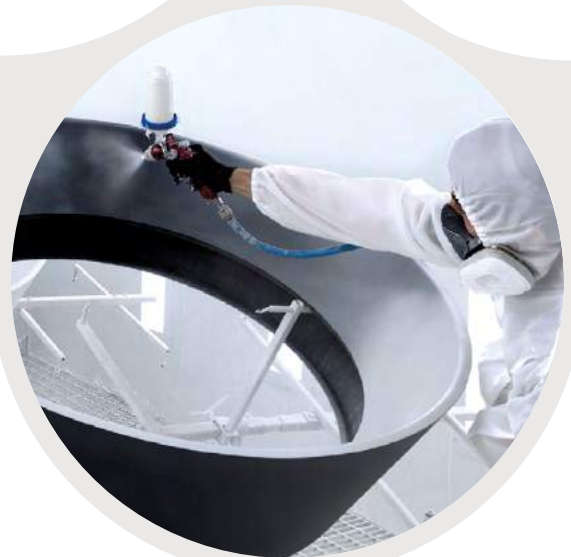

100% smart
On-Demand Production

Efficient

High-Tech Machinery

Energiebedarf um 30 Prozent gesenkt

Modern und umweltschonend muss es sein. Unsere Maschinenparks sind mit intelligenter Software ausgestattet, um das Material-Ressourcen-Verhältnis zu optimieren und Energie zu sparen. Außerdem nutzen wir pulverbeschichtete Öfen der neuesten Generation, die durch Wärmerückgewinnung den Primär-Energiebedarf um 30 Prozent senken.



Energy demand reduced by 30%

Cutting edge and environmentally friendly is our motto. Our production site is equipped with intelligent software to optimise the material-resource ratio and save energy. In addition, we use powder-coated ovens of the latest generation, which reduce the primary energy requirement by 30% through heat recovery.

100% Waterpurified LED-Board Production



Eigene Wasseraufbereitung nach höchsten EU-Umweltstandards

Wir überlassen nichts dem Zufall. Deshalb haben wir eine eigene Wasseraufbereitungsanlage, die in einem geschlossenen Umlaufsystem die Ressourcen der Rohplatinen-Produktion zurückgewinnt und recycelt. Natürlich richten wir uns dabei zu 100% nach strikten, europäischen Umweltstandards.

In-house water treatment to the highest EU environmental standards

We leave nothing to chance. That's why we have our own water treatment plant, which recovers and recycles the resources from the production of raw blanks in a closed circulation system. Of course, we comply 100% with strict European environmental standards.





Wir nutzen zu 100% erneuerbare Energien

Ja, wir produzieren unsere Leuchten komplett selbst, aber auch dafür brauchen wir Strom! Bei unserem in-House Fertigungsprozess achten wir jedoch darauf, dass dieser zu 100% aus regenerativen Energien wie Photovoltaik und Windkraft gewonnen wird.



We use 100% renewable energy

Yes, we produce all our luminaires ourselves, but we need electricity for that too! In our in-house production process, however, we make sure that it is generated 100% from renewable energies such as photovoltaics and wind power.

100%
Renewable Electricity

**Zeitloses Design ist per se nachhaltig.
Gute Qualität ist immer im Trend.**

Deshalb setzen wir auf Langlebigkeit unserer Produkte durch zeitlose ästhetische Gestaltung und qualitativ hochwertige und austauschbare Komponenten. Selbstverständlich auch zum Ende der Lebensdauer. Zerlegbarkeit der Produkte in ihre Einzelbestandteile und recyclingfähige Werkstoffe sind wesentlicher Bestandteil einer konsequent auf Nachhaltigkeit ausgerichteten Produktphilosophie.



**Timeless design is sustainable design.
Quality is an eternal value.**

That is why we focus on timeless aesthetic design and replaceable, high-quality components. Minimalist sizes are just as important to us as modern recyclable materials and the ability to dismantle products into individual components at the end of their service life.

Eco-friendly Product Design

Low Carbon Aluminium

**CO₂ footprint reduced to
4.0 kg (per kg of aluminium)**

We cannot produce without aluminium. But here, too, we have a choice in suppliers. We therefore select smelters that operate with the highest possible efficiency and obtain their energy from hydropower. In this way we reduce the CO₂ footprint to 4.0 kg CO₂ per kg aluminium - a quarter of the global average.

**CO₂-Fußabdruck auf 4,0 kg
(pro kg Aluminium) gesenkt**

Ohne Aluminium geht es nicht. Doch auch hier haben wir beim Lieferanten die Wahl. Wir wählen deshalb Hütten aus, die mit einem höchstmöglichen Wirkungsgrad arbeiten und ihre Energie aus Wasserkraft beziehen. So senken wir den CO₂-Fußabdruck auf 4,0 kg CO₂ pro kg Aluminium - ein Viertel des globalen Durchschnitts.

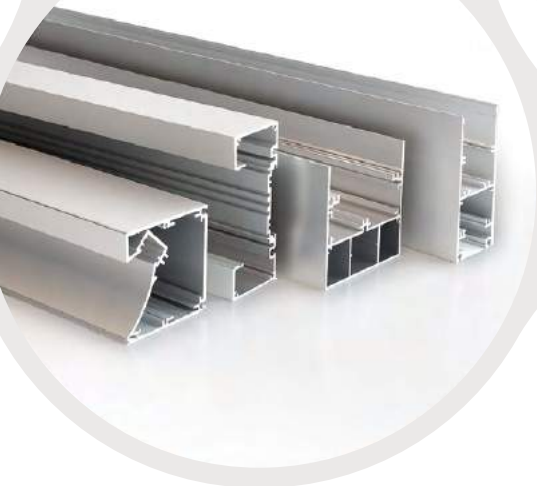



Natural wool from sustainable sources

Plastic foam for acoustic absorbers?
Not with us! We mainly use natural wool from sustainable sources, which, unlike plastic, is 100% biodegradable.

Naturwolle aus nachhaltiger Haltung

Kunststoff-Schaum für akustische Absorber?
Nicht bei uns! Wir verwenden hauptsächlich Naturwolle aus nachhaltiger Haltung, die im Gegensatz zu Kunststoff zu 100% biologisch abbaubar ist



Pure Wool
for Acoustic Absorbers



Trucircle

Polycarbonate

Waste product of the wood industry as raw material

Sustainable polycarbonate which is used in some of our Opal diffusers uses a waste product from the wood industry as raw material: it is made with 59% pine oil and is ISCC certified according to the Mass Balancing Principle.

Abfallprodukt der Holzindustrie als Rohstoff

Das Polycarbonat, das wir für Opal-Diffusoren einsetzen, nutzt ein Abfallprodukt der Holzindustrie als Rohstoff: Es wird mit 59% Kiefernöl hergestellt und ist nach dem Mass-Balancing-Prinzip ISCC zertifiziert.



0% Plastic in Packaging



0% Plastik in der Verpackung

Verpackung komplett aus Kartonagen? Machen wir schon jahrelang! Selbstverständlich ohne Styroporeinsätze und ohne Plastikfolien. Sogar die Stretch-Folie, mit der wir unsere Paletten umwickeln, ist biologisch abbaubar.



0% plastic in packaging

Packaging made entirely of cardboard. We have been doing this for years! Of course, without polystyrene inserts and without plastic film. Even the stretch film we use to wrap our pallets is biodegradable.



Zero waste thanks to local recycling

We even produce our packaging in-house and according to demand. We produce the cardboard boxes in such a way that every piece of waste is directly processed into pulp. And from this, new packaging parts are created again. 0% waste with 100% local recycling.

Null Verpackungs-Müll dank lokalem Kreislauf

Selbst unsere Verpackungen stellen wir In-House und bedarfsgerecht her. Wir produzieren die Kartonagen so, dass jedes Stück Abfall direkt zu Zellstoff verarbeitet wird.

Und daraus entstehen dann wieder neue Verpackungsteile.

0% Abfall bei 100% lokaler Kreislaufwirtschaft.



0% Waste
in Packaging

Certified Quality



Fünf Jahre Garantie auf das gesamte Sortiment

Qualität, Leistung und Lebensdauer – all das muss bei unseren Leuchten stimmen. Unsere Ingenieure optimieren unsere Produkte daher ständig und unsere Entwicklungs- und Testeinrichtungen sind nach DIN EN ISO 9001 zertifiziert. Unser Produktportfolio mit Prüfzeichen für Europa (ENEC), USA/Kanada (ETL), Mexico (NOM) und Australien (RCA) wächst stetig. Und weil wir sicher sind, dass unsere Leuchten lange halten, gibt's fünf Jahre Garantie. Auf alles.



Five-year warranty on the entire range

Quality, performance, and durability - all these components have to be perfect in our luminaires. Our engineers are therefore constantly optimising our products and our development and testing facilities are certified according to DIN EN ISO 9001. Our product portfolio with test marks for Europe (ENEC), USA/Canada (ETL), Mexico (NOM) and Australia (RCA) is constantly growing. And because we are sure that our luminaires will last a long time, we offer a five-year warranty. On everything.



**Divers, inklusiv & gleiches
Gehalt für m/w/d**

Verschiedenen Perspektiven sind eine Grundlage für Erfolg. Wir setzen auf multikulti und ein Team aus über 15 Nationen. Denn wir wissen: Kreativität braucht Vielfalt und deshalb fördern wir Inklusion, respektieren jedes Individuum unabhängig von Herkunft oder Geschlecht und zahlen gleiches Geld für gleiche Leistung.

**Diverse, inclusive & equal
salary for m/f/d**

Diverse perspectives are a basis for success. We rely on multiculturalism and a team from over 15 nations. Because we know: Creativity needs diversity and that's why we promote inclusion, respect every individual regardless of origin or gender and pay equal money for equal performance.

Diversity
Inclusion & Equal
Gender Pay

Was die Zukunft bringt

Unser Ziel ist die emissionsfreie Kreislaufwirtschaft. Auch wenn der Weg noch etwas länger ist, wir sind unterwegs.

What the future holds

Our goal is an emission-free circular economy. Even if the road is still a little longer, we are on our way.

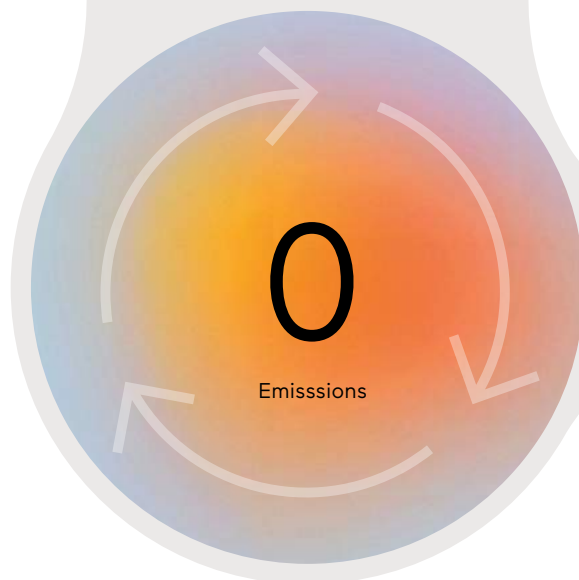



To Be
Continued...



Midpin C2/C3 |
48V Track
30



Midpoint C6 |
3-Phase Track
34



Midpoint C7 |
3-Phase DALI Track
36



Basic Déco C3 |
3-Phase Track
38



Liquid Line Compact C5 |
3-Phase Track
40



Liquid Line CX | System
40mm 3-Phase Track
42



Cubic Evolution C4 |
3-Phase Track
44



Matric Déco C9 |
System 55mm 3-Phase Track
46



3-Phase Track
48

Stromschiene | Track

Midpin Track



Private Residence, Bielsko-Biala, Poland
Midpin | C2/C3





Midpin C2/C3 | 48V Track

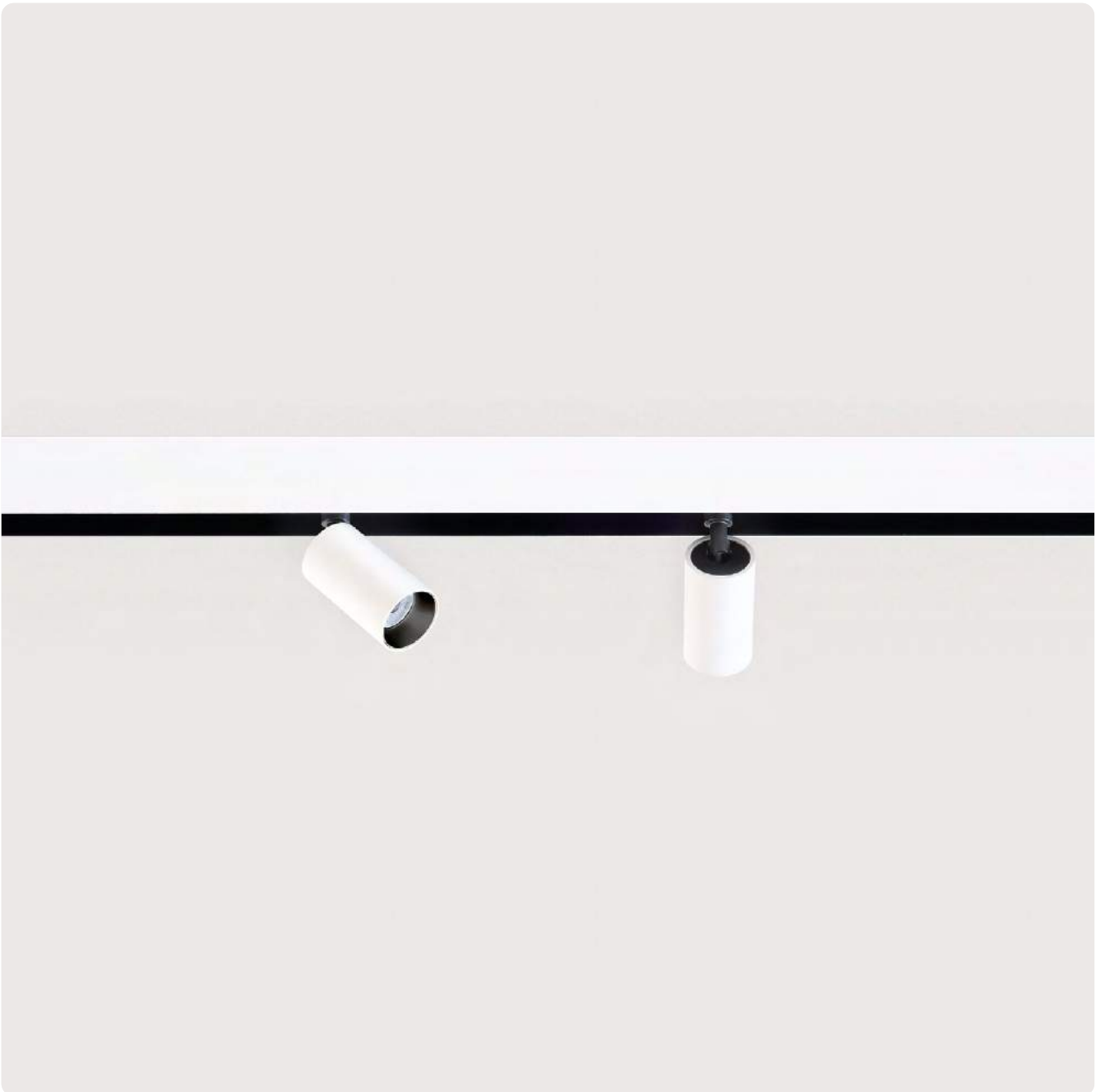

DE LED-Strahler für 48V-Stromschienen. Typ C2: 350° drehbar und 90° schwenkbar. Typ C3: Pendelausführung, direktstrahlend. Gehäuse aus Aluminium in weiß, silber, schwarz oder champagnerfarben lackiert. Weitere Oberflächenoptionen siehe Lightnet Surface Collection oder RAL nach Wahl. Adapter und Innenseite der Stromschienen immer schwarz. Farbtemperatur wahlweise 2700K, 3000K oder 4000K oder als Dim to Warm 3000K-1800K. Farbwiedergabe CRI>90. Binning initial \leq MacAdam 3. Austauschbare Linsenoptik mit Ausstrahlwinkel 30° (Medium) oder 40° (Flood). Optikring in verschiedenen Farbausführungen erhältlich. Wahlweise einfach schaltbar oder stufenlos dimmbar (DALI). Separat bestellbar: 48V Stromschienen für Einbau-, Anbau- oder Pendelmontage mit externen 48V Betriebsgeräten oder Matric-Lichtlinien (System 40mm) mit integrierten 48V-Stromschienen und Betriebsgeräten. Maximale Systemflexibilität durch umfangreiches Standardsortiment an Winkelverbindern sowie Zuschnitt nach Maß.

EN LED spotlight for 48V tracks. Type C2: 350° rotation and 90° tilt. Type C3: Pendant version, direct only light distribution. Housing made of white, silver, black or champagne coated aluminum. For further colour finishes please see the Lightnet-Surface-Collection or select your RAL of choice. Adapter and inside of track are always black. Colour temperature available as 2700K, 3000K or 4000K or as Dim to Warm 3000K-1800K. Colour rendering CRI>90. Binning \leq MacAdam 3. Changeable lens optics with beam angle 30° (medium) or 40° (flood). Optic ring available in different colour versions. Optionally switchable or dimmable (DALI). Separately orderable: 48V tracks for recessed, surface or pendant mounting with external 48V control gear or Matric light lines (System 40mm) with integrated 48V tracks and control gear. Maximum system flexibility due to extensive standard range of angle connectors and custom-made lengths.

DC2BBE-927M-B

Product Family	D: Midpin
Type	C2: Build-In Version for Low Voltage Magnetic Track, C3: Suspended Version for Low Voltage Magnetic Track
Lens Angle	B: Medium 30°, C: Flood 40°
Surface Finish	W: Snow White, V: Ivory White, S: Radiant Silver, B: Jet Black, H: Anodic Champagne
Control Gear	E: On/Off, L: DALI
Colour Rendering	9: CRI>90
Colour Temperature	27: 2700K, 30: 3000K, 35: 3500K, 40: 4000K, DW: Dim to Warm 1800K-3000K [DALI only]
Power	M: Medium Power
Optic Ring	W: Snow White, V: Ivory White, A: Satin Silver, B: Jet Black, H: Anodic Champagne, G: Satin Gold, K: Satin Copper



Medium 30° Led Engine Eco, Medium Power

Mounting Height	Illuminance [Lux] center/side	Beam Diameter
1 m	2079/929	0.57 m
2 m	520/232	1.10 m
3 m	231/103	1.70 m
4 m	130/58	2.30 m

LED Engine	2700K	3000K	3500K	4000K
11W	610 lm	710 lm	750 lm	750 lm

Flood 40° Led Engine Eco, Medium Power

Mounting Height	Illuminance [Lux] center/side	Beam Diameter
1 m	1454/591	0.77 m
2 m	364/148	1.50 m
3 m	162/66	2.30 m
4 m	91/37	3.10 m

LED Engine	2700K	3000K	3500K	4000K
11W	620 lm	730 lm	770 lm	770 lm

Midpin C2 Build-In Version



Track Recessed, 2000mm:
X-LV-TRACK-L2000-L-B [BLACK]

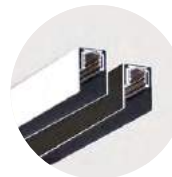

Track Surface, length on request:
X-LV-TRACK-Lxxx-A-B [BLACK]
X-LV-TRACK-Lxxx-A-W [WHITE]



Straight Mechanical Connector:
X-LV-CONNECTOR-B [BLACK]



Straight Electrical Connector:
X-LV-SCOUPLER-B [BLACK]



Feed:
X-LV-FEED-B [BLACK]



Corner Connector:
X-LV-LCOUPLER-B [BLACK]

Midpin C3 Suspended Version

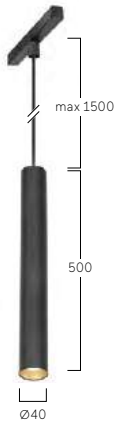

End Cap:
X-LV-CAP-L-B [RECESSED BLACK]



Installation Set for Track Recessed:
X-LV-SUSP-1,5M-B [1,5M BLACK]
X-LV-SUSP-4M-B [4M BLACK]



Converter:
X-LV-CONVERTER-70W-E [70W, ON/OFF]
X-LV-CONVERTER-100W-E [100W, ON/OFF]
X-LV-CONVERTER-150W-E [150W, ON/OFF]
X-LV-CONVERTER-70W-L [70W, DALI]
X-LV-CONVERTER-100W-L [100W, DALI]
X-LV-CONVERTER-150W-L [150W, DALI]



B Jet Black
W Snow White



B Jet Black
A Satin Silver



B Jet Black
B Jet Black

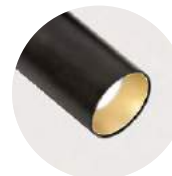

B Jet Black
G Satin Gold

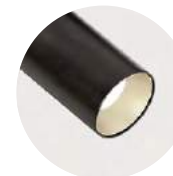

B Jet Black
H Anodic Champagne



B Jet Black
K Satin Copper

Midpoint Track



AIB Headquarters, Dublin, Ireland

Midpoint C7

Photography: Donal Murphy Photography, Planning: dlight



Vektor Informatik, Stuttgart, Germany
Midpoint C7
Photography: piaschweisserphotography.com

St. Vincentius Clinic, Karlsruhe, Germany
Midpoint C7



Midpoint C6 | 3-Phase Track



DE LED-Strahler für 3-Phasen-Stromschienen. 350° drehbar und 90° schwenkbar. Konverter im Strahlerkopf integriert, einfach schaltbar. Gehäuse aus Aluminium in weiß, silber, schwarz oder champagnerfarben lackiert. Weitere Oberflächenoptionen siehe Lightnet Surface Collection oder RAL nach Wahl. LED-Engine wahlweise XICATO ARTIST für höchste Lichtqualität mit bester Farbwiedergabe (CRI>97) und 5 Jahre Garantie für Farbkonstanz (MacAdam≤3) oder ECO für höchste Energieeffizienz bei optimalem Preis-Leistungsverhältnis und CRI>90. Farbtemperatur 2700K, 3000K oder 4000K. Austauschbarer Linsen-Reflektor mit sphärischer Facettenoptik. Ausstrahlwinkel: 10° (Spot), 20° (Medium), 35° (Flood) oder 50° (Wide Flood). Standardmäßig klare Abdeckung. Reflektorring in verschiedenen Farbausführungen erhältlich. Stromschienenadapter wahlweise EUTRAC oder GLOBAL. Optional zusätzliche Filter oder Wabenraster.

EN LED spotlight for 3-phase tracks. 350° rotation and 90° tilt. Driver integrated into spotlight head, switchable. Housing made of white, silver, black or champagne coated aluminum. For further colour finishes please see the Lightnet-Surface-Collection or select your RAL of choice. LED Engine with XICATO ARTIST for highest light quality and colour rendering (CRI>97), including 5-year warranty for colour consistency (MacAdams3) or ECO for highest energy efficiency with optimal price-performance ratio and CRI>90. Colour temperature 2700K, 3000K or 4000K. Replaceable lens reflector optic with spherical faceted optic. Beam angle: 10° (Spot), 20° (Medium), 35° (Flood) or 50° (Wide Flood). Standard clear cover. Reflector ring available in different colours. Track adapter options, EUTRAC or GLOBAL. Optional additional filters or honeycomb louvre.

P C 6 B S E - 9 27 F M - B K G

Product Family	P: Midpoint
Type	C6: For 3-Phase Tracks [Tube Length 155mm]
Beam Angle	A: Spot 10°, B: Medium 20°, C: Flood 35°, D: Wide Flood 50°
Surface Finish	W: Snow White, V: Ivory White, S: Radiant Silver, B: Jet Black, H: Anodic Champagne
Control Gear	E: On/Off
Colour Rendering	9: CRI>90
Colour Temperature	27: 2700K, 30: 3000K, 40: 4000K
Led-Engine	F: Eco [Ra> 90], A: Artist [Ra> 97, Xicato]
Power	E: Low Power M: Medium Power
Optic Ring	W: Snow White, V: Ivory White, S: Radiant Silver, B: Jet Black, H: Anodic Champagne, G: Satin Gold, K: Satin Copper
Cover	K: Clear Cover [Standard], P: Prismatic Lens, H: Honeycomb Louvre
Adaptor	G: Global Adaptor, E: Eutrac Adaptor
On Request	Optic Removal Tool for clear cover



Spot 10° Led Engine Eco, Medium Power

Mounting Height	Illuminance [Lux] center/side	Beam Diameter
1 m	25250/12700	0.24 m
2 m	6312/3175	0.48 m
3 m	2806/1411	0.72 m
4 m	1578/794	0.95 m

LED Engine	2700K	3000K	4000K
Eco Low Power [19W]	1230 lm	1350 lm	1440 lm
Eco Medium Power [31W]	1660 lm	1860 lm	2020 lm
Artist Low Power [19W]	1040 lm	1090 lm	1190 lm
Artist Medium Power [31W]	1400 lm	1480 lm	1560 lm

Medium 20° Led Engine Eco, Medium Power

Mounting Height	Illuminance [Lux] center/side	Beam Diameter
1 m	17447/8455	0.32 m
2 m	4362/2114	0.64 m
3 m	1939/939	0.96 m
4 m	1090/528	1.30 m

LED Engine	2700K	3000K	4000K
Eco Low Power [19W]	1580 lm	1740 lm	1850 lm
Eco Medium Power [31W]	2360 lm	2640 lm	2870 lm
Artist Low Power [19W]	1330 lm	1390 lm	1510 lm
Artist Medium Power [31W]	1980 lm	2110 lm	2220 lm

Flood 35° Led Engine Eco, Medium Power

Mounting Height	Illuminance [Lux] center/side	Beam Diameter
1 m	6251/2731	0.63 m
2 m	1563/683	1.30 m
3 m	695/303	1.90 m
4 m	391/171	2.50 m

LED Engine	2700K	3000K	4000K
Eco Low Power [19W]	1530 lm	1680 lm	1790 lm
Eco Medium Power [31W]	2280 lm	2550 lm	2780 lm
Artist Low Power [19W]	1290 lm	1350 lm	1470 lm
Artist Medium Power [31W]	1930 lm	2060 lm	2160 lm

Wide Flood 50° Led Engine Eco, Medium Power

Mounting Height	Illuminance [Lux] center/side	Beam Diameter
1 m	3550/1319	0.94 m
2 m	887/330	1.90 m
3 m	394/147	2.80 m
4 m	222/82	3.80 m

LED Engine	2700K	3000K	4000K
Eco Low Power [19W]	1440 lm	1580 lm	1680 lm
Eco Medium Power [31W]	2230 lm	2490 lm	2710 lm
Artist Low Power [19W]	1250 lm	1310 lm	1430 lm
Artist Medium Power [31W]	1910 lm	2040 lm	2140 lm



Optic Removal Tool for clear cover



Eutrac Adaptor



Global Adaptor

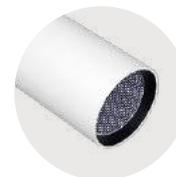

Honeycomb Louvre



Prismatic Lens



W Snow White
W Snow White



W Snow White
B Jet Black



W Snow White
G Satin Gold



S Radiant Silver
S Radiant Silver



B Jet Black
B Jet Black



B Jet Black
G Satin Gold

Midpoint C7 | 3-Phase DALI Track



DE LED-Strahler für 3-Phasen-Stromschienen. 350° drehbar und 90° schwenkbar. Konverter im Strahlerkopf integriert, dimmbar (DALI). Gehäuse aus Aluminium in weiß, silber, schwarz oder champagnerfarben lackiert. LED-Engine wahlweise XICATO ARTIST für höchste Lichtqualität mit bester Farbwiedergabe (CRI>97) und 5 Jahre Garantie für Farbkonstanz (MacAdam \leq 3) oder ECO für höchste Energieeffizienz bei optimalem Preis-Leistungsverhältnis und CRI>90. Farbtemperatur 2700K, 3000K oder 4000K. Austauschbarer Linsen-Reflektor mit sphärischer Facettenoptik. Ausstrahlwinkel: 10° (Spot), 20° (Medium), 35° (Flood) oder 50° (Wide Flood). Standardmäßig klare Abdeckung. Reflektoring in verschiedenen Farbausführungen erhältlich. Stromschienenadapter wahlweise EUTRAC oder GLOBAL. Optional zusätzliche Filter oder Wabenraster.

EN LED spotlight for 3-phase tracks. 350° rotation and 90° tilt. Driver integrated into spotlight head, dimmable (DALI). Housing made of white, silver, black or champagne coated aluminum. LED Engine with XICATO ARTIST for highest light quality and colour rendering (CRI>97), including 5 year warranty for colour consistency (MacAdams 3) or ECO for highest energy efficiency with optimal price-performance ratio and CRI> 90. Colour temperature 2700K, 3000K or 4000K. Replaceable lens reflector optic with spherical faceted optic. Beam angle: 10° (Spot), 20° (Medium), 35° (Flood) or 50° (Wide Flood). Standard clear cover. Reflector ring available in different colours. Track adapter options, EUTRAC or GLOBAL. Optional additional filters or honeycomb louvre.

PC7BSL-927FM-BKG

Product Family	P: Midpoint
Type	C7: For 3-Phase Tracks [Tube Length 215mm]
Beam Angle	A: Spot 10°, B: Medium 20°, C: Flood 35°, D: Wide Flood 50°
Surface Finish	W: Snow White, V: Ivory White, S: Radiant Silver, B: Jet Black, H: Anodic Champagne
Control Gear	L: DALI
Colour Rendering	9: CRI>90
Colour Temperature	27: 2700K, 30: 3000K, 40: 4000K
Led-Engine	F: Eco [Ra> 90], A: Artist [Ra> 97, Xicato]
Power	E: Low Power M: Medium Power
Optic Ring	W: Snow White, V: Ivory White, S: Radiant Silver, B: Jet Black, H: Anodic Champagne, G: Satin Gold, K: Satin Copper
Cover	K: Clear Cover [Standard], P: Prismatic Lens, H: Honeycomb Louvre
Adaptor	G: Global Adaptor, E: Eutrac Adaptor
On Request	Optic Removal Tool for clear cover



Spot 10° Led Engine Eco, Medium Power

Mounting Height	Illuminance [Lux] center/side	Beam Diameter
1 m	25250/12700	0.24 m
2 m	6312/3175	0.48 m
3 m	2806/1411	0.72 m
4 m	1578/794	0.95 m

LED Engine	2700K	3000K	4000K
Eco Low Power [19W]	1230 lm	1350 lm	1440 lm
Eco Medium Power [31W]	1660 lm	1860 lm	2020 lm
Artist Low Power [19W]	1040 lm	1090 lm	1190 lm
Artist Medium Power [31W]	1400 lm	1480 lm	1560 lm

Medium 20° Led Engine Eco, Medium Power

Mounting Height	Illuminance [Lux] center/side	Beam Diameter
1 m	17447/8455	0.32 m
2 m	4362/2114	0.64 m
3 m	1939/939	0.96 m
4 m	1090/528	1.30 m

LED Engine	2700K	3000K	4000K
Eco Low Power [19W]	1580 lm	1740 lm	1850 lm
Eco Medium Power [31W]	2360 lm	2640 lm	2870 lm
Artist Low Power [19W]	1330 lm	1390 lm	1510 lm
Artist Medium Power [31W]	1980 lm	2110 lm	2220 lm

Flood 35° Led Engine Eco, Medium Power

Mounting Height	Illuminance [Lux] center/side	Beam Diameter
1 m	6251/2731	0.63 m
2 m	1563/683	1.30 m
3 m	695/303	1.90 m
4 m	391/171	2.50 m

LED Engine	2700K	3000K	4000K
Eco Low Power [19W]	1530 lm	1680 lm	1790 lm
Eco Medium Power [31W]	2280 lm	2550 lm	2780 lm
Artist Low Power [19W]	1290 lm	1350 lm	1470 lm
Artist Medium Power [31W]	1930 lm	2060 lm	2160 lm

Wide Flood 50° Led Engine Eco, Medium Power

Mounting Height	Illuminance [Lux] center/side	Beam Diameter
1 m	3550/1319	0.94 m
2 m	887/330	1.90 m
3 m	394/147	2.80 m
4 m	222/82	3.80 m

LED Engine	2700K	3000K	4000K
Eco Low Power [19W]	1440 lm	1580 lm	1680 lm
Eco Medium Power [31W]	2230 lm	2490 lm	2710 lm
Artist Low Power [19W]	1250 lm	1310 lm	1430 lm
Artist Medium Power [31W]	1910 lm	2040 lm	2140 lm



Optic Removal Tool for clear cover



Eutrac Adaptor



Global Adaptor

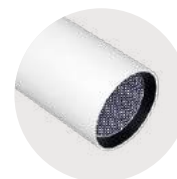

Honeycomb Louvre



Prismatic Lens



W Snow White
W Snow White

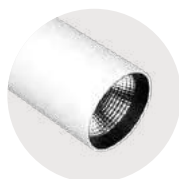

W Snow White
B Jet Black



W Snow White
G Satin Gold



S Radiant Silver
S Radiant Silver



B Jet Black
B Jet Black



B Jet Black
G Satin Gold

Basic Déco C3 | 3-Phase Track



DE LED-Strahler für 3-Phasen-Stromschienen. 345° drehbar und 90° schwenkbar. Leuchtenkörper aus Aluminiumprofil mit Bauhöhe 58mm. Gehäuse-Außenfläche und Innendekor in unterschiedlichen Lackierungen und Kombinationen erhältlich, z.B. weiß, silber, graphit, schwarz, gold oder kupferfarben. Zu Oberflächenoptionen- und Kombinationen siehe Lightnet-Surface-Collection oder Bi-Colour-Auswahl. Rückversetzte Microprismenoptik mit optimierter Blendungsbegrenzung speziell für Office-Anwendungen. Satinierter Opaldiffusor für Allgemeinbeleuchtung mit max. Transmissionsgrad und homogener Lichtpunktauflösung. Konverter in Leuchtgehäuse integriert, wahlweise einfach schaltbar oder stufenlos dimmbar (DALI). Farbtemperatur 2200K, 2700K, 3000K, 3500K, 4000K oder 6500K. Binning initial \leq MacAdam 3. Farbwiedergabe CRI>80, CRI>90 oder Full Spectrum. 3-Phasen-Schienenadapter wahlweise EUTRAC oder GLOBAL.

EN LED spotlight for 3-phase tracks. 345° rotation and 90° tilt. Luminaire body made of aluminium profile with overall height of 58mm. Outer housing and inner decor available in various finishes and combinations, e.g. white, silver, graphite, black, gold or copper coated. For further colour finishes please see the Lightnet-Surface-Collection or select your RAL of choice. Recessed microprismatic diffuser with optimized glare reduction especially for workplaces. Satin opal diffuser for general lighting with maximum transmittance and homogeneous lighting. With integrated driver options of switchable or dimmable (DALI). Colour temperature 2200K, 2700K, 3000K, 3500K, 4000K or 6500K. Binning \leq MacAdam 3. Colour rendering CRI>80, CRI>90 or Full Spectrum. 3-phase track adapter options, EUTRAC or GLOBAL.

B C 3 O S E - 8 30M - D300 - E G

Product Family	B: Basic
Type	C3: Direct only
Optical System	A: Microprismatic, O: Opal Diffuser
Surface Finish	W: Snow White, V: Ivory White, S: Radiant Silver, U: Urban Graphite, B: Jet Black, H: Anodic Champagne, K: Satin Copper
Control Gear	E: On/Off, L: DALI
Colour Rendering	8: CRI>80, 9: CRI>90, F: Full Spectrum [except 2200K]
Colour Temperature	22: 2200K, 27: 2700K, 30: 3000K, 35: 3500K, 40: 4000K, 65: 6500K
Power	M: Medium Power, H: High Power
Size	Luminaire Diameter in mm: D300
Adaptor	G: Global Adaptor, E: Eutrac Adaptor
Reflector	W: Snow White, V: Ivory White, S: Radiant Silver, U: Urban Graphite, B: Jet Black, H: Anodic Champagne, K: Satin Copper, G: Satin Gold



Microprismatic | Direct

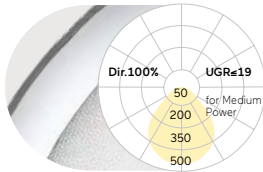

Opal Diffuser | Direct

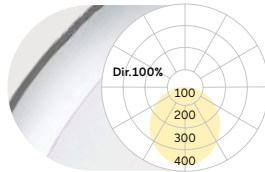

D mm	Lumen/Watt Medium Power	Lumen/Watt High Power	D mm	Lumen/Watt Medium Power	Lumen/Watt High Power
300	830lm/8W	1430lm/13W	300	810lm/8W	1400lm/13W

Lumen Values: Luminaire luminous flux at 4000K/CRI>80. Other configurations on request.



W Snow White
W Snow White



S Radiant Silver
S Radiant Silver



U Urban Graphite
U Urban Graphite



B Jet Black
B Jet Black



H Anodic Champagne
H Anodic Champagne



K Satin Copper
K Satin Copper

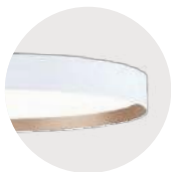

W Snow White
K Satin Copper

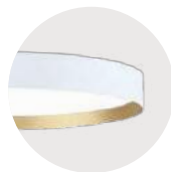

W Snow White
G Satin Gold



W Snow White
B Jet Black



H Anodic Champagne
B Jet Black



B Jet Black
G Satin Gold



B Jet Black
W Snow White

Liquid Line Compact C5 | 3-Phase Track



DE LED-Strahler für 3-Phasen-Stromschienen. 345° drehbar und 90° schwenkbar. Leuchtenkörper mit feinen Radien aus Aluminium, gefertigt aus einem Guss ohne sichtbare Nahtstellen an den Stirnseiten. Oberfläche in weiß, silber, graphit, schwarz oder champagnerfarben lackiert. Weitere Oberflächenoptionen siehe Lightnet Surface Collection oder RAL nach Wahl. Präzisionslinsen mit Abblendraster für breite rotationssymmetrische Lichtstärkeverteilung bei gleichzeitig hoher Blendungsbegrenzung (UGR<19). Bicolour Option durch andersfarbiges Abblendraster in sämtlichen Oberflächenfarben. Konverter in Leuchtengehäuse integriert, wahlweise einfach schaltbar oder stufenlos dimmbar (DALI). Farbtemperatur 2200K, 2700K, 3000K, 3500K, 4000K oder 6500K. Binning initial \leq MacAdam 3. Farbwiedergabe CRI>80 oder CRI>90. 3-Phasen-Schienenadapter wahlweise EUTRAC oder GLOBAL.

EN LED spotlight for 3-phase tracks. 345° rotation and 90° tilt. Luminaire body with smooth bends made of aluminium, crafted in one piece with no visible seams at the ends. Surface white, silver, graphite, black or champagne coated. Further surface options see Lightnet-Surface-Collection or RAL of your choice. Precision lenses with louvre for wide uniform symmetrical light distribution with low glare (UGR<19). Bicolour option with different-coloured louvre in all surface colours. Driver integrated into luminaire housing, optionally switchable or dimmable (DALI). Colour temperature 2200K, 2700K, 3000K, 3500K, 4000K or 6500K. Binning \leq MacAdam 3. Colour rendering CRI>80 or CRI>90. 3-phase track adapter options, EUTRAC or GLOBAL.

Q C5 LWE - 8 30 H - L139-G B*

Product Family	Q: Liquid Line
Type	C5: Direct only
Optical System	O: Opal Diffuser, L: Lens Louvre*
Surface Finish	W: Snow White, V: Ivory White, A: Satin Silver, S: Radiant Silver, U: Urban Graphite, B: Jet Black, H: Anodic Champagne, K: Satin Copper
Control Gear	E: On/Off, L: DALI
Colour Rendering	8: CRI>80, 9: CRI>90, F: Full Spectrum [except 2200K]
Colour Temperature	22: 2200K, 27: 2700K, 30: 3000K, 35: 3500K, 40: 4000K, 65: 6500K
Power	M: Medium Power, H: High Power
Size	Luminaire Length in mm: L139
Adaptor	G: Global Adaptor, E: Eutrac Adaptor
Lens Louvre*	W: Snow White, A: Satin Silver, B: Jet Black, H: Anodic Champagne, K: Satin Copper, G: Satin Gold



Lens Louvre | Direct

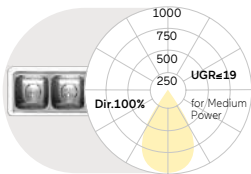

Opal Diffuser | Direct

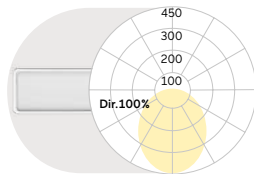

L	Lumen/Watt	Lumen/Watt
mm	Medium Power	High Power
139	620lm/7W	820lm/9W

L	Lumen/Watt	Lumen/Watt
mm	Medium Power	High Power
139	530lm/7W	720lm/9W

Lumen Values: Luminaire luminous flux at 4000K/CRI>80. Other configurations on request.

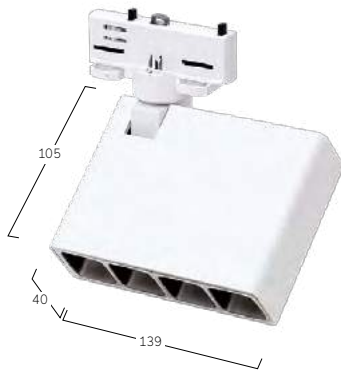

Liquid Line CX | System 40mm 3-Phase Track



DE LED-Anbauleuchte mit Adapter für 3-Phasen-Stromschienen. Direktstrahlend. Leuchtenkörper mit feinen Radien aus Aluminium, gefertigt aus einem Guss ohne sichtbare Nahtstellen an den Stirnseiten. Oberfläche weiß, silber, graphit, schwarz oder champagnerfarben lackiert. Weitere Oberflächenoptionen siehe Lightnet-Surface-Collection oder RAL nach Wahl. Präzisionslinsen mit Abblendraster für breite rotationssymmetrische Lichtstärkeverteilung bei gleichzeitig hoher Blendungsbegrenzung (UGR<19) speziell für Office-Anwendungen. Abblendraster in verschiedenen Farbausführungen erhältlich. Alternativ Satinierter Opaldiffusor für Allgemeinbeleuchtung mit max. Transmissionsgrad und homogener Lichtpunktauflösung. Konverter in Leuchtengehäuse integriert, wahlweise einfach schaltbar oder stufenlos dimmbar (DALI). Farbtemperatur 2200K, 2700, 3000K, 3500K, 4000K oder 6500K. Binning initial \leq MacAdam 3. Farbwiedergabe CRI>80, CRI>90 oder Full Spectrum. 3-Phasen-Schienenadapter wahlweise EUTRAC oder GLOBAL.

EN LED surface-mounted luminaire with 3-phase track adapter. Direct only light distribution. Luminaire body with smooth bends made of aluminium, crafted in one piece with no visible seams at the ends. Surface white, silver, graphite, black or champagne coated. Further surface options see Lightnet-Surface-Collection or RAL of your choice. Precision lenses with louvre for wide uniform symmetrical light distribution with low glare (UGR<19) especially for workplaces. Louvre available in various colour finishes. Optional satin opal diffuser for general lighting with maximum transmittance and homogeneous lighting. Driver integrated into luminaire housing, optionally switchable or dimmable (DALI). Colour temperature 2200K, 2700, 3000K, 3500K, 4000K or 6500K. Binning \leq MacAdam 3. Colour rendering CRI>80, CRI>90 or Full Spectrum. 3-phase adapter options, EUTRAC or GLOBAL.

QCX OWE-8 30M-L1182-GB*

Product Family	Q: Liquid Line
Type	CX: Direct only
Optical System	O: Opal Diffuser, L: Lens Louvre*
Surface Finish	W: Snow White, V: Ivory White, A: Satin Silver, S: Radiant Silver, U: Urban Graphite, B: Jet Black, H: Anodic Champagne, K: Satin Copper
Control Gear	E: On/Off, L: DALI
Colour Rendering	8: CRI>80, 9: CRI>90, F: Full Spectrum [except 2200K]
Colour Temperature	22: 2200K, 27: 2700K, 30: 3000K, 35: 3500K, 40: 4000K, 65: 6500K
Power	E: Low Power, M: Medium Power, H: High Power
Size	Luminaire Length in mm (Opal Diffuser): L600, L890, L1182, L1475, L1765, L2055 Luminaire Length in mm (Lens Louvre*): L668, L932, L1197, L1461, L1726, L1990
Adaptor	G: Global Adaptor, E: Eutrac Adaptor
Lens Louvre*	W: Snow White, A: Satin Silver, B: Jet Black, H: Anodic Champagne, K: Satin Copper, G: Satin Gold
On Request	Midpin Spotlights

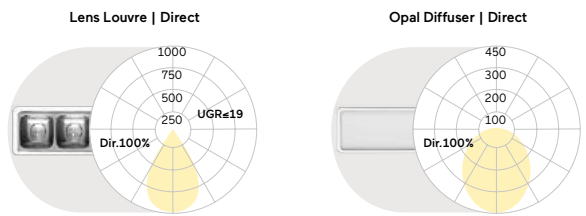

L mm	Lumen/Watt		L mm	Lumen/Watt	
	Low Power	High Power		Medium Power	High Power
668	1090lm/10W	2000lm/17W	600	870lm/9W	1180lm/12W
932	1520lm/13W	2790lm/24W	890	1300lm/12W	1760lm/16W
1197	1960lm/16W	3590lm/30W	1182	1730lm/15W	2350lm/21W
1461	2390lm/19W	4390lm/37W	1475	2160lm/19W	2940lm/25W
1726	2830lm/23W	5190lm/43W	1765	2600lm/22W	3530lm/30W
1990	3260lm/26W	5990lm/49W	2055	3030lm/28W	4110lm/37W

Lumen Values: Luminaire luminous flux at 4000K/CRI>80. Other configurations on request.



Midpin Spotlight XM
770lm/10W/Ø40mm



W Snow White
W Snow White

W Snow White
A Satin Silver

W Snow White
B Jet Black

W Snow White
H Anodic Champagne

W Snow White
K Satin Copper

W Snow White
G Satin Gold

Cubic Evolution C4 | 3-Phase Track



DE LED-Anbauleuchte mit Adapter für 3-Phasen-Stromschienen. Direktstrahlend. Leuchtenkörper in minimalistischer Bauhöhe aus Aluminiumprofil. Oberfläche natureloxiert oder weiß, graphit, schwarz bzw. champagnerfarben lackiert. Weitere Oberflächenoptionen siehe Lightnet-Surface-Collection oder RAL nach Wahl. Microprismenoptik mit optimierter Blendungsbegrenzung speziell für Office-Anwendungen. Satinierter Opaldiffusor für Allgemeinbeleuchtung mit max. Transmissionsgrad und homogener Lichtpunktauflösung. Konverter in Leuchtengehäuse integriert, wahlweise einfach schaltbar oder stufenlos dimmbar (DALI). Farbtemperatur 2200K, 2700K, 3000K, 3500K, 4000K oder 6500K. Binning initial \leq MacAdam 3. Farbwidrigkeit CRI>80, CRI>90 oder Full Spectrum. Adapter für 3-Phasen Stromschienen wahlweise EUTRAC oder GLOBAL. Auf Anfrage: Multisensor sowie Integration von Notlichtkomponenten.

EN LED surface-mounted luminaire with 3-phase track adapter. Direct only light distribution. Luminaire body with minimalistic overall height made of aluminium profile. Surface natural anodised or white, graphite, black or champagne coated. Further surface options see Lightnet-Surface-Collection or RAL of your choice. Microprismatic screen with optimized glare reduction especially for workplaces. Satin opal diffuser for general lighting with maximum transmittance and homogeneous lighting. Driver integrated into luminaire housing, optionally switchable or dimmable (DALI). Colour temperature 2200K, 2700K, 3000K, 3500K, 4000K or 6500K. Binning \leq MacAdam 3. Colour rendering CRI>80, CRI>90 or Full Spectrum. Adapter for 3-phase adapter options, EUTRAC or GLOBAL. On request: Multi-sensor, integral emergency lighting module.

C C4 A B E-8 30 M-L900-G

- Product Family **C:** Cubic
- Type **C4:** Direct only
- Optical System **A:** Microprismatic, **O:** Opal Diffuser
- Surface Finish **W:** Snow White, **E:** Silver Anodised, **U:** Urban Graphite, **B:** Jet Black, **H:** Anodic Champagne
- Control Gear **E:** On/Off, **L:** DALI
- Colour Rendering **8:** CRI>80, **9:** CRI>90, **F:** Full Spectrum [except 2200K]
- Colour Temperature **22:** 2200K, **27:** 2700K, **30:** 3000K, **35:** 3500K, **40:** 4000K, **65:** 6500K
- Power **M:** Medium Power, **H:** High Power
- Size Luminaire Length in mm: **L900, L1200, L1500**
- Adaptor **G:** Global Adaptor, **E:** Eutrac Adaptor
- On Request Multisensor



Microprismatic | Direct

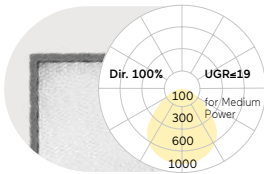

Opal Diffuser | Direct

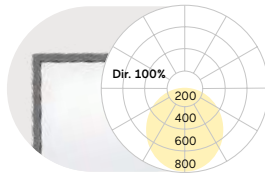

L mm	Lumen/Watt		L mm	Lumen/Watt	
	Medium Power	High Power		Medium Power	High Power
900	2280lm/21W	2930lm/26W	900	2170lm/21W	2730lm/26W
1200	3050lm/27W	3900lm/34W	1200	2890lm/27W	3650lm/34W
1500	3700lm/32W	4880lm/43W	1500	3460lm/32W	4560lm/43W

Lumen Values: Luminaire luminous flux at 4000K/CRI>80. Other configurations on request.

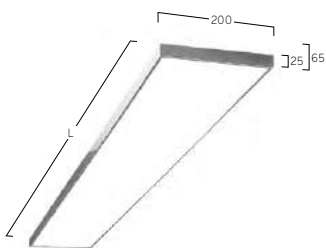

Multisensor



W Snow White



E Silver Anodised



U Urban Graphite



B Jet Black



H Anodic Champagne

Matric Déco C9 | System 55mm 3-Phase Track



DE LED-Anbauleuchte mit Adapter für 3-Phasen-Stromschienen. Direktstrahlend. Lichtkanal aus Aluminiumprofil mit 55mm Profillbreite. Millimetergenaue Längenfertigung nach Vorgabe möglich. Rückversetzte Optik für bessere Blendungsbegrenzung und dekorative Lichtwirkung. Gehäuse-Außenfläche und Innendekor in unterschiedlichen Lackierungen und Kombinationen erhältlich. Oberflächenoptionen siehe Lightnet-Surface-Collection oder RAL nach Wahl. Präzisionslinsen mit Abblenderaster für breite rotationssymmetrische Lichtstärkeverteilung bei gleichzeitig hoher Blendungsbegrenzung (UGR<19). Abblenderaster und Reflektoring in gleicher Farbausführung. Microprismenoptik mit optimierter Blendungsbegrenzung speziell für Office-Anwendungen. Opaldiffusor aus satiniertem Acrylglas für Allgemeinbeleuchtung. Konverter in Leuchtgehäuse integriert, wahlweise einfach schaltbar oder stufenlos dimmbar (DALI). Farbtemperatur 2200K, 2700K, 3000K, 3500K, 4000K oder 6500K. Binning initial \leq MacAdam 3. Farbwiedergabe CRI>80, CRI>90 oder Full Spectrum. Stromschienenadapter wahlweise EUTRAC oder GLOBAL.

EN LED surface-mounted luminaire with 3-phase track adapter. Direct only light distribution. Light channel made of aluminium profile with 55mm profile width. Bespoke lengths possible. Recessed screen with optimized glare reduction and decorative lighting impact. Outer housing and inner decorative trim available in various finishes and combinations. Further surface options see Lightnet-Surface-Collection or RAL of your choice. Precision lenses with louvre for wide uniform symmetrical light distribution with high glare limitation (UGR<19). Louvre and decorative trim in same colour finish. Microprismatic screen with optimized glare reduction especially for workplaces. Opal diffuser made of acrylic glass for general lighting. Driver integrated into luminaire housing, optionally switchable or dimmable (DALI). Colour temperature 2200K, 2700K, 3000K, 3500K, 4000K or 6500K. Binning \leq MacAdam 3. Colour rendering CRI>80, CRI>90 or Full Spectrum. Track adapter options, EUTRAC or GLOBAL.

L C9 LWE-8 30E-L1209-GB

Product Family	L: Matric
Type	C9: Direct only
Optical System	A: Microprismatic, O: Opal Diffuser, L: Lens Louvre
Surface Finish	W: Snow White, V: Ivory White, A: Satin Silver, E: Silver Anodised, U: Urban Graphite, B: Jet Black, H: Anodic Champagne, K: Satin Copper
Control Gear	E: On/Off, L: DALI
Colour Rendering	8: CRI>80, 9: CRI>90, F: Full Spectrum [except 2200K]
Colour Temperature	22: 2200K, 27: 2700K, 30: 3000K, 35: 3500K, 40: 4000K, 65: 6500K
Power	E: Low Power, M: Medium Power, H: High Power
Size	Luminaire Length in mm (Microprismatic, Opal Diffuser): L600, L890, L1182, L1475, L1765, L2055 Luminaire Length in mm (Lens Louvre): L681, L945, L1209, L1474, L1738, L2002
Adaptor	G: Global Adaptor, E: Eutrac Adaptor
Reflector Colour	W: Snow White, V: Ivory White, S: Radiant Silver, U: Urban Graphite, B: Jet Black, H: Anodic Champagne, K: Satin Copper, G: Satin Gold



Lens Louvre | Direct

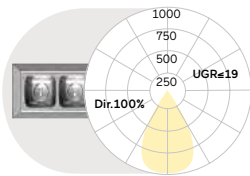

Microprismatic | Direct

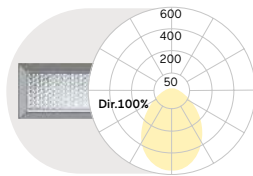

Opal Diffuser | Direct

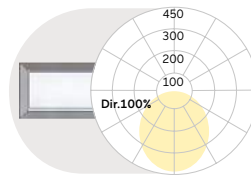

L mm	Lumen/Watt Low Power	Lumen/Watt High Power
681	1090lm/10W	2000lm/17W
945	1520lm/13W	2790lm/24W
1209	1960lm/16W	3590lm/30W
1474	2390lm/19W	4390lm/37W
1738	2830lm/23W	5190lm/43W
2002	3260lm/26W	5990lm/49W

L mm	Lumen/Watt Low Power	Lumen/Watt High Power
600	550lm/7W	990lm/12W
890	830lm/10W	1490lm/16W
1182	1110lm/12W	1990lm/21W
1475	1390lm/14W	2480lm/25W
1765	1660lm/17W	2980lm/30W
2055	1940lm/22W	3480lm/37W

L mm	Lumen/Watt Medium Power	Lumen/Watt High Power
600	780lm/9W	1060lm/12W
890	1170lm/12W	1590lm/16W
1182	1560lm/15W	2110lm/21W
1475	1950lm/19W	2640lm/25W
1765	2330lm/22W	3170lm/30W
2055	2720lm/28W	3700lm/37W

Lumen Values: Luminaire luminous flux at 4000K/CRI>80. Other configurations on request.



W Snow White
W Snow White



A Satin Silver
W Snow White



A Satin Silver
B Jet Black



B Jet Black
H Anodic Champagne



B Jet Black
G Satin Gold



W Snow White
K Satin Copper



W Snow White
W Snow White

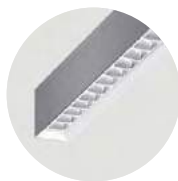

A Satin Silver
W Snow White



B Jet Black
A Satin Silver



B Jet Black
B Jet Black

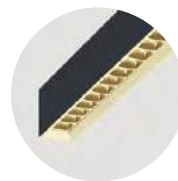

B Jet Black
G Satin Gold



K Satin Copper
W Snow White

3-Phase Tracks



DE 3-Phasen-Stromschienen für Einbau-, Anbau- oder Pendelmontage. Kompatibel mit allen Leuchten mit GLOBAL-Adapttern. Aluminiumprofil in weiß oder schwarz lackiert. Wahlweise in Ausführung schaltbar oder dimmbar (DALI). Maximale Systemflexibilität durch umfangreiches Standard-sortiment an Verbindern, Abhängungen sowie Zuschnitt nach Maß. Bei Systemen automatische Beistellung von Maßskizzen zur Möglichkeit der Prüfung bestellter Konfigurationen.

EN 3-phase tracks for recessed, surface or pendant mounting. Compatible with all luminaires with GLOBAL adapters. Aluminium profile coated in white or black. Optional in switchable or dimmable version (DALI). Maximum system flexibility due to extensive standard range of connectors, suspensions and customizing cut to size. For systems, drawings are provided to allow the design and specification to be reviewed.



Track Surface, 2000mm (for Global Adaptor):
 X-HV-TRACK-L2000-E-A-B [ON/OFF, BLACK]
 X-HV-TRACK-L2000-E-A-W [ON/OFF, WHITE]
 X-HV-TRACK-L2000-L-A-B [DALI, BLACK]
 X-HV-TRACK-L2000-L-A-W [DALI, WHITE]



Track Recessed, 2000mm (for Global Adaptor):
 X-HV-TRACK-L2000-E-L-B [ON/OFF, BLACK]
 X-HV-TRACK-L2000-E-L-W [ON/OFF, WHITE]
 X-HV-TRACK-L2000-L-L-B [DALI, BLACK]
 X-HV-TRACK-L2000-L-L-W [DALI, WHITE]



Feed:
 X-HV-RFEED-B [BLACK RIGHT]
 X-HV-RFEED-W [WHITE RIGHT]
 X-HV-LFEED-B [BLACK LEFT]
 X-HV-LFEED-W [WHITE LEFT]



End Cap Surface:
 X-HV-CAP-A-B [SURFACE BLACK]
 X-HV-CAP-A-W [SURFACE WHITE]



End Cap Recessed:
 X-HV-CAP-L-B [RECESSED BLACK]
 X-HV-CAP-L-W [RECESSED WHITE]



Straight Connector:
 X-HV-SCOUPLER-B [BLACK]
 X-HV-SCOUPLER-W [WHITE]



Corner Connector:
 X-HV-LICOUPLER-B [BLACK, INT. EARTH]
 X-HV-LICOUPLER-W [WHITE, INT. EARTH]
 X-HV-LECOUPLER-B [BLACK, EXT. EARTH]
 X-HV-LECOUPLER-W [WHITE, EXT. EARTH]



Flex Connector:
 X-HV-FLEXCOUPLER-B [BLACK]
 X-HV-FLEXCOUPLER-W [WHITE]



Suspension Set:
 X-HV-SUSPENSION-1500-B [BLACK, 1,5M]
 X-HV-SUSPENSION-1500-W [WHITE, 1,5M]
 X-HV-SUSPENSION-4000-B [BLACK, 4M]
 X-HV-SUSPENSION-4000-W [WHITE, 4M]



Lucille T1 |
Table
54



Beam Me Up T1 |
Mini Table Office
56



Beam Me Up T2 |
Mini Table Home
58



Cubic Evolution
T2/T3 | Table
60



Liquid Line TY | System
40mm Table Symmetric
62



Liquid Line TX | System
40mm Table Asymmetric
64

Tisch | Table

Lucille Table



Inwerk – Office Culture Forum, Meerbusch, Germany
Lucille T1
Photography: Tomas Rodriguez





Academy at the Humboldt Forum
Berlin, Germany
Lucille T1

Inwerk – Office Culture Forum, Meerbusch, Germany
Lucille T1
Photography: Tomas Rodriguez



Academy at the Humboldt Forum
Berlin, Germany
Lucille T1



Lucille T1 | Table



DE LED-Arbeitsplatzleuchte. Direktstrahlend. Microprismenoptik aus Acrylglas für optimierte Entblendung und Lichtlenkung. Höchstmöglicher Transmissionsgrad für energieeffizientes Arbeiten bei gleichmäßiger Ausleuchtung der relevanten Arbeitsflächen. Minimalistischer Leuchtenkopf mit perfekt homogener und vollflächiger Auflösung der Lichtpunkte. Hochwertiger Pantograf mit Präzisionsgelenken komplett aus Aluminium. Keine sichtbaren Kabel, Federn oder Seile. Oberfläche wahlweise weiß, silber, schwarz oder champagnerfarben lackiert. Intuitive Bedienung über Touchfeld im Leuchtenkopf. Lichtlevel stufenlos dimmbar. Hohe Flexibilität durch Arbeits-Erfassungsbereich bis 1 m. Kippsicherheit auch in Maximalstellung. Farbtemperatur 2700K, 3000K, 3500K, 4000K oder 6500K. Binning initial \leq MacAdam 3. Farbwiedergabe CRI>80, CRI>90 oder Full Spectrum. Wahlweise mit Fußplatte aus Stahl, Tischklammer, Tischaufsatzbefestigung. Adapter für USM-HALLER und weitere Systeme auf Anfrage erhältlich.

EN LED task light. Direct only light distribution. Microprismatic screen made of acrylic glass for optimised glare control and light direction. Highest possible transmittance for energy-efficient working with homogeneous illumination of the focused work areas. Minimalistic luminaire head with perfect uniform and enhanced light transmission. High-quality precision joints made completely from aluminium. No visible cables, springs or cords. Surface available in white, silver, black or champagne. Intuitive control via touch control panel in the luminaire head, allowing. Smooth dimming, with extension of head up to 1m. Tilt resistance in maximum position. Colour temperature 2700K, 3000K, 3500K, 4000K or 6500K. Binning \leq MacAdam 3. Colour rendering CRI>80, CRI>90 or Full Spectrum. Optionally available with steel base plate, table clamp, table top attachment. USM Haller adapter and additional systems available on request.

UT1ABS-830M-D150-G

Product Family	U: Lucille
Type	T1: Direct only
Optical System	A: Microprismatic
Surface Finish	V: Ivory White, A: Satin Silver, B: Jet Black, H: Anodic Champagne
Control Gear	S: Switch & Dimm
Colour Rendering	8: CRI>80, 9: CRI>90, F: Full Spectrum [except 2200K]
Colour Temperature	27: 2700K, 30: 3000K, 35: 3500K, 40: 4000K, 65: 6500K
Power	M: Medium Power
Size	Head Diameter in mm: D150
Base	G: Table Base, T: Table Clamp, R: Table Grommet, A: USM Haller Adaptor



Microprismatic | Direct

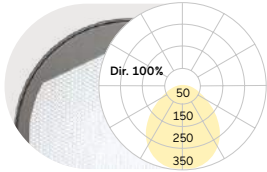

D mm	Lumen/Watt Medium Power
150	1000lm/13W

Lumen Values: Luminarie luminous flux at 4000K/CRI>80. Other configurations on request.

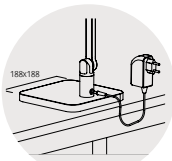

Table Base

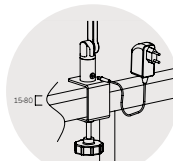

Table Clamp

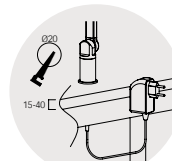
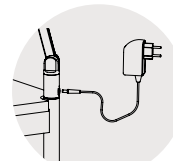

Table Grommet



USM Haller Adaptor



W Ivory White



A Satin Silver



B Jet Black



H Anodic Champagne

Beam Me Up T1 | Mini Table Office



DE LED-Arbeitsplatzleuchte mit rückversetzter Optik und dekorativem Reflektoring. Direkt-indirektstrahlend. Leuchtschirm aus hochwertig verarbeitetem Fiberglas. Gehäuse-Außenfläche und dekorativer Reflektoring in unterschiedlichen Lackierungen und Kombinationen erhältlich, z.B. weiß, silber, graphit, schwarz, gold oder kupferfarben lackiert. Zu Oberflächenoptionen- und Kombinationen siehe Lightnet-Surface-Collection oder Bi-Colour-Auswahl. Microprismenoptik mit optimierter Blendungsbegrenzung speziell für Office-Anwendungen. Satinierter Opaldiffusor für homogene Lichtpunktauflösung. Intuitives Bedienfeld im Leuchtenmast für getrennt stufenlose Dimmung und Schaltung der Kammern für Direkt-/Indirektlicht. Farbtemperatur 2200K, 2700K, 3000K, 3500K, 4000K, 6500K. Binning initial \leq MacAdam 3. Farbwiedergabe CRI $>$ 80, CRI $>$ 90 oder Full Spectrum. Wahlweise mit Tischklammer, Tischaufsatzbefestigung, USM-Haller-Adapter oder – auf Anfrage – mit Sonderbefestigung erhältlich. 4m Anschlusskabel mit länderspezifischem Stecker (EU, CH, UK).

EN LED task light with rebated lens optic set in a Decorative ring. Direct-indirect light distribution. Luminaire shade made of highquality processed fiberglass. Outer housing and Decorative reflector ring available in various finishes and combinations, e.g. white, silver, graphite, black, gold or copper coated. Further surface options see Lightnet-Surface-Collection or RAL of your choice. Microprismatic screen with optimized glare reduction especially for workplaces. Satin opal diffuser for homogeneous lighting. Intuitive pole mounted control panel for dimming and switching the direct/indirect light separately. Colour temperature 2200K, 2700K, 3000K, 3500K, 4000K or 6500K. Binning \leq MacAdam 3. Colour rendering CRI $>$ 80, CRI $>$ 90 or Full Spectrum. Optionally available with table clamp, table top attachment, USM Haller adapter or - upon request - with special attachment. 4m power cable with country-specific plug (EU, CH, UK).

MT1 A B X-8 30M-D450-TG-A

Product Family	M: Beam Me Up
Type	T1: Direct-Indirect
Optical System	A: Microprismatic, O: Opal Diffuser
Surface Finish	W: Snow White, V: Ivory White, A: Satin Silver, U: Urban Graphite, B: Jet Black, H: Anodic Champagne, K: Satin Copper
Control Gear	X: Separately Dimmable
Colour Rendering	8: CRI>80, 9: CRI>90, F: Full Spectrum [except 2200K]
Colour Temperature	22: 2200K, 27: 2700K, 30: 3000K, 35: 3500K, 40: 4000K, 65: 6500K
Power	M: Medium Power
Size	Head Diameter in mm: D450
Base	T: Table Clamp
Reflector	W: Snow White, V: Ivory White, A: Satin Silver, U: Urban Graphite, B: Jet Black, H: Anodic Champagne, K: Satin Copper, G: Satin Gold
Plug	A: Schuko CEE 7/7 (Type E+F), B: CH T12 (Type J), C: UK BS 1363 (Type G), D: Wieland, E: WAGO



Microprismatic | Direct-Indirect

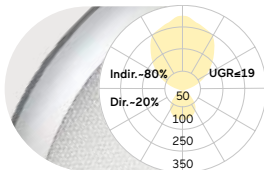

D	Lumen/Watt
mm	Medium Power
450	9050lm/74W

Opal Diffuser | Direct-Indirect

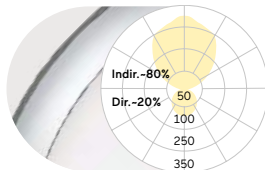

D	Lumen/Watt
mm	Medium Power
450	9050lm/74W

Lumen Values: Luminaire luminous flux at 4000K/CRI>80. Other configurations on request.

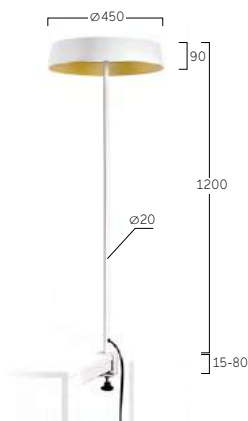

Table Clamp



Separately Dimmable



W Snow White
G Satin Gold



W Snow White
K Satin Copper



A Satin Silver
B Jet Black



B Jet Black
A Satin Silver



B Jet Black
G Satin Gold



B Jet Black
H Anodic Champagne

Beam Me Up T2 | Mini Table Home



DE LED-Tischleuchte mit rückversetzter Optik und dekorativem Reflektorring. Direkt-indirektstrahlend. Leuchtenschirm aus hochwertig verarbeitetem Fiberglas. Gehäuse-Außenfläche und dekorativer Reflektorring in unterschiedlichen Lackierungen und Kombinationen erhältlich, z.B. weiß, silber, graphit, schwarz, gold oder kupferfarben lackiert. Zu Oberflächenoptionen und Kombinationen siehe Lightnet-Surface-Collection oder Bi-Colour-Auswahl. Satinierter Opaldiffusor für homogene Lichtpunktauflösung. Intuitives Bedienfeld im Leuchtenmast für getrennt stufenlose Dimmung und Schaltung der Kammern für Direkt-/Indirektlicht. Farbtemperatur 2200K, 2700K oder 3000K. Binning initial \leq MacAdam 3. Farbwiedergabe CRI>80, CRI>90 oder Full Spectrum. Fußplatte aus Stahl. 4m Anschlusskabel mit länderspezifischem Stecker (EU, CH, UK).

EN LED task light with rebated lens optic set in a Decorative ring. Direct-indirect light distribution. Luminaire shade made of high-quality processed fiberglass. Outer housing and Decorative reflector ring available in various finishes and combinations, e.g. white, silver, graphite, black, gold or copper coated. Further surface options see Lightnet-Surface-Collection or RAL of your choice. Satin opal diffuser for homogeneous lighting. Intuitive pole mounted control panel for dimming and switching the direct/indirect light separately. Colour temperature 2200K, 2700K or 3000K. Binning \leq MacAdam 3. Colour rendering CRI>80, CRI>90 or Full Spectrum. Base steel plate. 4m power cable with country-specific plug (EU, CH, UK).

MT2 A B X-8 30 M-D350-GG-A

Product Family	M: Beam Me Up
Type	T2: Direct-Indirect
Optical System	A: Microprismatic, O: Opal Diffuser
Surface Finish	W: Snow White, V: Ivory White, A: Satin Silver, U: Urban Graphite, B: Jet Black, H: Anodic Champagne, K: Satin Copper
Control Gear	X: Separately Dimmable
Colour Rendering	8: CRI>80, 9: CRI>90, F: Full Spectrum [except 2200K]
Colour Temperature	22: 2200K, 27: 2700K, 30: 3000K
Power	M: Medium Power
Size	Head Diameter in mm: D350, D450
Base	G: Table Base
Reflector	W: Snow White, V: Ivory White, A: Satin Silver, U: Urban Graphite, B: Jet Black, H: Anodic Champagne, K: Satin Copper, G: Satin Gold
Plug	A: Schuko CEE 7/7 (Type E+F), B: CH T12 (Type J), C: UK BS 1363 (Type G), D: Wieland, E: WAGO



Microprismatic | Direct-Indirect

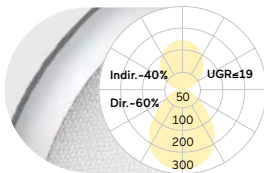

D mm	Lumen/Watt Medium Power
350	2760lm/27W
450	3540lm/33W

Opal Diffuser | Direct-Indirect

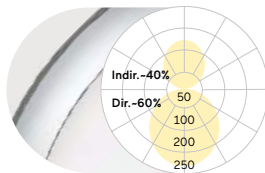

D mm	Lumen/Watt Medium Power
350	2760lm/27W
450	3540lm/33W

Lumen Values: Luminaire luminous flux at 3000K/CRI>80. Other configurations on request.



Table Base



Separately Dimmable



W Snow White
G Satin Gold



W Snow White
K Satin Copper



A Satin Silver
B Jet Black



B Jet Black
A Satin Silver



B Jet Black
G Satin Gold



B Jet Black
H Anodic Champagne

Cubic Evolution T2/T3 | Table



DE LED-Tischleuchte. Direkt-indirektstrahlend. Leuchtenkörper in minimalistischer Bauhöhe aus Aluminiumprofil. Oberfläche naturel oxidiert oder weiß, graphit, schwarz bzw. champagnerfarben lackiert. Weitere Oberflächenoptionen siehe Lightnet-Surface-Collection oder RAL nach Wahl. Microprismenoptik mit optimierter Blendungsbegrenzung speziell für Office-Anwendungen bei vollständiger Lichtpunktauflösung. Intuitives Bedienfeld im Leuchtenmast für getrennt stufenlose Dimmung und Schaltung der Kammern für Direkt-/Indirektlicht, alternativ gemeinsame Steuerung über modernste Sensor- oder Schwarmtechnologie. Farbtemperatur 2700K, 3000K, 3500K, 4000K, 6500K oder Tunable White (2700-6500K). Binning initial \leq MacAdam 3. Farbwiedergabe CRI $>$ 80, CRI $>$ 90 oder Full Spectrum. Tischklammer aus Stahl, Lackierung passend Leuchtenkörper. 4m Anschlusskabel mit länderspezifischem Stecker (EU, CH, UK).

EN LED table luminaire. Direct-indirect light distribution. Luminaire body with minimalistic overall height made of aluminium profile. Surface natural anodised or white, graphite, black or champagne coated. Further surface options see Lightnet-Surface-Collection or RAL of your choice. Microprismatic screen with optimized glare reduction especially for workplaces with uniform and enhanced light transmission. Intuitive pole mounted control panel for dimming and switching the direct/indirect light separately, alternatively controllable together via state-of-the-art sensor or swarm technology. Colour temperature 2700K, 3000K, 3500K, 4000K, 6500K or Tunable White (2700-6500K). Binning \leq MacAdam 3. Colour rendering CRI $>$ 80, CRI $>$ 90 or Full Spectrum. Steel table clamp, colour matching luminaire body. 4m power cable with country-specific plug (EU, CH, UK).

CT3 A B X - 8 30 M - L600 - T - A

Product Family	C: Cubic
Type	T2: Direct-Indirect, T3: Direct-Indirect
Optical System	A: Microprismatic
Surface Finish	W: Snow White, E: Silver Anodised, U: Urban Graphite, B: Jet Black, H: Anodic Champagne
Control Gear	X: Separately Dimmable, M: Multisensor, R: Swarm Control
Colour Rendering	8: CRI>80, 9: CRI>90, F: Full Spectrum
Colour Temperature	27: 2700K, 30: 3000K, 35: 3500K, 40: 4000K, 65: 6500K
Power	M: Medium Power, H: High Power
Size	Head Length in mm: L600
Base	T: Table Clamp
Plug	A: Schuko CEE 7/7 (Type E+F), B: CH T12 (Type J), C: UK BS 1363 (Type G), D: Wieland, E: WAGO



CT2: Microprismatic | Direct-Indirect

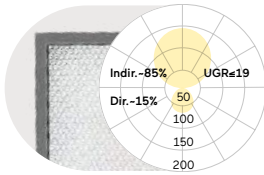

L mm	Lumen/Watt Medium Power	Lumen/Watt High Power
600	11100lm/68W	15300lm/92W

CT3: Microprismatic | Direct-Indirect

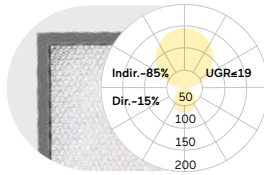

L mm	Lumen/Watt Medium Power	Lumen/Watt High Power
600	11100lm/75W	15300lm/104W

Lumen Values: Luminarie luminous flux at 4000K/CRI>80. Other configurations on request.



T2 Direct-Indirect



T3 Direct-Indirect



Multisensor / Swarm Control



Separately Dimmable



W Snow White



E Silver Anodised



U Urban Graphite



B Jet Black



H Anodic Champagne

Liquid Line TY | System 40mm Table Symmetric



DE LED-Arbeitsplatzleuchte. Direktstrahlend. Leuchtenkörper mit feinen Radien aus Aluminium, gefertigt aus einem Guss ohne sichtbare Nahtstellen. Oberfläche weiß, silber, graphit, schwarz oder champagnerfarben lackiert. Weitere Oberflächenoptionen siehe Lightnet-Surface-Collection oder RAL nach Wahl. Direktanteil über Präzisionslinsen mit Abblendraster für breite rotationssymmetrische Lichtstärkeverteilung bei gleichzeitig hoher Blendungsbegrenzung (UGR<19). Abblendraster in verschiedenen Farbkombinationen erhältlich. Intuitives Bedienfeld im Leuchtenmast für stufenlose Dimmung. Farbtemperatur 2700K, 3000K, 3500K, 4000K oder 6500K. Binning initial \leq MacAdam 3. Farbwiedergabe CRI>80, CRI>90 oder Full Spectrum. Wahlweise mit Fußplatte aus Stahl oder Tischklammer.

EN LED task light. Direct only light distribution. Luminaire body with smooth bends made of aluminium, crafted in one piece with no visible seams. Surface white, silver, graphite, black or champagne coated. Further surface options see Lightnet-Surface-Collection or RAL of your choice. Direct light using precision lenses with louvre for wide uniform symmetrical light distribution with high glare limitation (UGR<19). Louvre available in various colour finishes. Intuitive pole mounted control panel for dimming. Colour temperature 2700K, 3000K, 3500K, 4000K or 6500K. Binning \leq MacAdam 3. Colour rendering CRI>80, CRI>90 or Full Spectrum. Optionally available with steel base plate or table clamp.

QTYLBS-830M-L936-TG

Product Family	Q: Liquid Line
Type	TY: Direct only
Optical System	L: Lens Louvre
Surface Finish	W: Snow White, V: Ivory White, A: Satin Silver, S: Radiant Silver, U: Urban Graphite, B: Jet Black, H: Anodic Champagne, K: Satin Copper
Control Gear	S: Switch & Dimm
Colour Rendering	8: CRI>80, 9: CRI>90, F: Full Spectrum
Colour Temperature	27: 2700K, 30: 3000K, 35: 3500K, 40: 4000K, 65: 6500K
Power	M: Medium Power
Size	Head Length in mm: L936
Base	G: Rectangular Base, U: U-Cut-Out Base, T: Table Clamp
Lens Louvre	W: Snow White, B: Jet Black, A: Satin Silver, H: Anodic Champagne, K: Satin Copper, G: Satin Gold



Lens Louvre | Direct

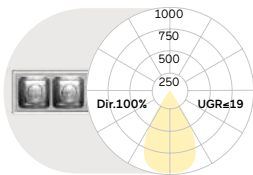

Size	Power	Lumen/Watt
936	Medium Power	1910lm/16W

Lumen Values: Luminarie luminous flux at 4000K/CRI>80. Other configurations on request.

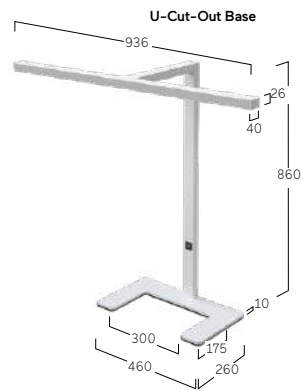

Rectangular Base



U-Cut-Out Base



Table Clamp



Switch & Dimm



W Snow White
W Snow White



W Snow White
A Satin Silver



W Snow White
B Jet Black



W Snow White
H Anodic Champagne



W Snow White
K Satin Copper



W Snow White
G Satin Gold

Liquid Line TX | System 40mm Table Asymmetric



DE LED-Arbeitsplatzleuchte. Direktstrahlend. Leuchtenkörper mit feinen Radien aus Aluminium, gefertigt aus einem Guss ohne sichtbare Nahtstellen. Oberfläche weiß, silber, graphit, schwarz oder champagnerfarben lackiert. Weitere Oberflächenoptionen siehe Lightnet-Surface-Collection oder RAL nach Wahl. Direktanteil über Präzisionslinsen mit Abblendraster für breite rotationssymmetrische Lichtstärkeverteilung bei gleichzeitig hoher Blendungsbegrenzung (UGR<19). Abblendraster in verschiedenen Farbkombinationen erhältlich. Intuitives Bedienfeld im Leuchtenmast für stufenlose Dimmung. Farbtemperatur 2700K, 3000K, 3500K, 4000K oder 6500K. Binning initial \leq MacAdam 3. Farbwiedergabe CRI>80, CRI>90 oder Full Spectrum. Wahlweise mit Fußplatte aus Stahl oder Tischklammer.

EN LED task light. Direct only light distribution. Luminaire body with smooth bends made of aluminium, crafted in one piece with no visible seams. Surface white, silver, graphite, black or champagne coated. Further surface options see Lightnet-Surface-Collection or RAL of your choice. Direct light using precision lenses with louvre for wide uniform symmetrical light distribution with high glare limitation (UGR<19). Louvre available in various colour finishes. Intuitive pole mounted control panel for dimming. Colour temperature 2700K, 3000K, 3500K, 4000K or 6500K. Binning \leq MacAdam 3. Colour rendering CRI>80, CRI>90 or Full Spectrum. Optionally available with steel base plate or table clamp.

QTX LBS-830M-L980-TG

Product Family	Q: Liquid Line
Type	TX: Direct only
Optical System	L: Lens Louvre
Surface Finish	W: Snow White, V: Ivory White, A: Satin Silver, S: Radiant Silver, U: Urban Graphite, B: Jet Black, H: Anodic Champagne, K: Satin Copper
Control Gear	S: Switch & Dimm
Colour Rendering	8: CRI>80, 9: CRI>90, F: Full Spectrum
Colour Temperature	27: 2700K, 30: 3000K, 35: 3500K, 40: 4000K, 65: 6500K
Power	M: Medium Power
Size	Head Length in mm: L980
Base	G: Rectangular Base, T: Table Clamp
Lens Louvre	W: Snow White, B: Jet Black, A: Satin Silver, H: Anodic Champagne, K: Satin Copper, G: Satin Gold



Lens Louvre| Direct

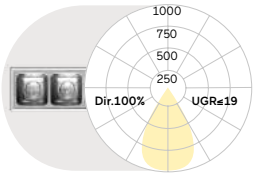

Size	Power	Lumen/Watt
980	Medium Power	1910lm/16W

Lumen Values: Luminarie luminous flux at 4000K/CRI>80. Other configurations on request.

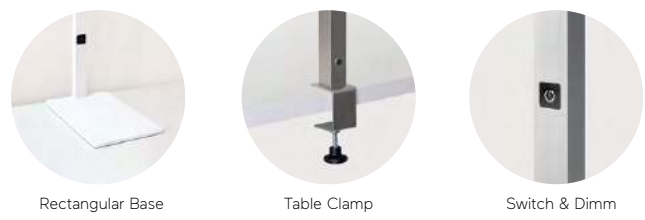
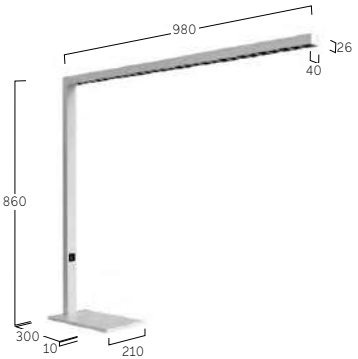



Grand Lucille S9 |
Floor
70



Lucille S1 |
Floor
74



Basic Neo S2 |
Floor
78



Basic Neo S4 |
Floor
80



Basic Déco S3 |
Floor
82



Basic Déco S5 |
Floor
84



Beam Me Up S1 |
Mini Floor
86



Beam Me Up S4 |
Floor
88



Beam Me Up S6 |
Floor
90



Liquid Line SX | System
40mm Floor One Head
92



Liquid Line SY | System
40mm Floor Two Heads
94



Caleo Neo S2 |
Floor
96



Caleo Neo S4 |
Floor
98



Cubic Evolution F1 |
Floor
104



Cubic Evolution F2 |
Floor
106



Cubic Evolution F3 |
Floor
108



Cubic Evolution F5/F6 |
Floor
110



Cubic Evolution F7 |
Floor
112



Cubic Evolution F8 |
Floor
114



Matric SX | System 40mm
Floor One Head
116



Matric SY | System 40 mm
Floor Two Heads
118

Steh | Floor

Grand Lucille Floor



Academy at the Humboldt
Forum, Berlin, Germany
Grand Lucille S9



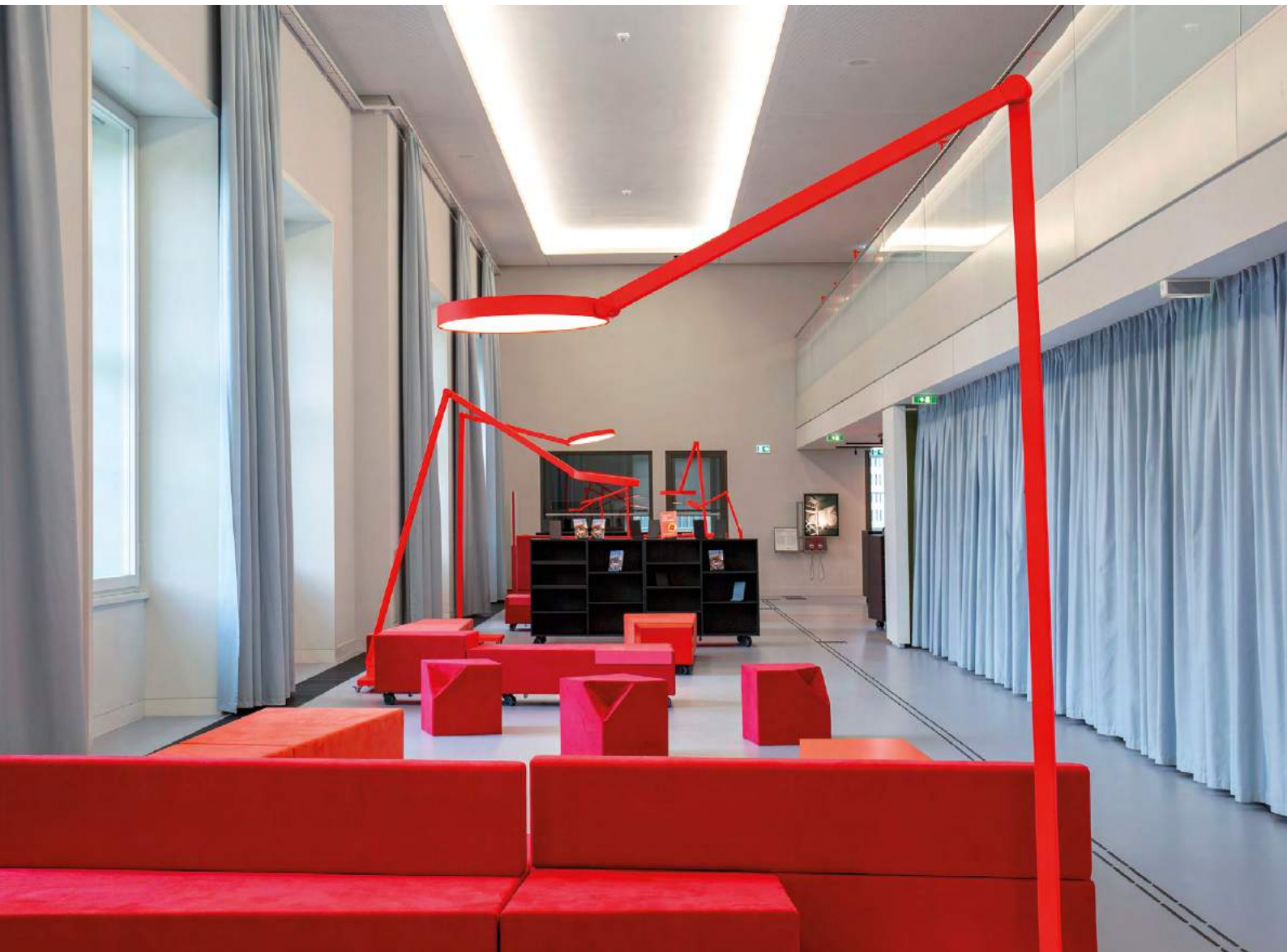
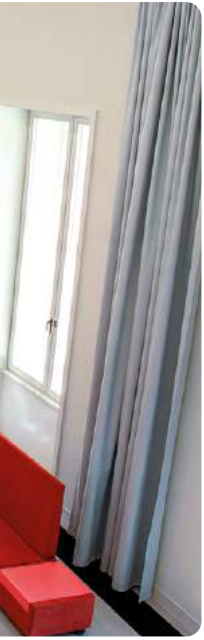

Grand Lucille S9 | Floor



DE LED-Stehleuchte. Direkt-indirektstrahlend. Microprismenoptik mit optimierter Blendungsbegrenzung speziell für Office-Anwendungen. Leuchtenkopf mit perfekt homogener und vollflächiger Auflösung der Lichtpunkte. Hochwertiger Pantograf mit Präzisionsgelenken komplett aus Aluminium. Keine sichtbaren Kabel, Federn oder Seile. Oberfläche wahlweise weiß, silber, schwarz oder champagnerfarben lackiert. Weitere Oberflächenoptionen siehe Lightnet-Surface-Collection oder RAL nach Wahl. Intuitives Bedienfeld im Leuchtenmast für getrennt stufenlose Dimmung und Schaltung der Kammern für Direkt-/Indirektlicht, bei Tunable White gemeinsame Steuerung der Lichtkammern. Standard Farbtemperatur 2700K, 3000K, 3500K, 4000K, 6500K oder Tunable White (2700K-6500K). Binning initial \leq MacAdam 3. Farbwiedergabe CRI>80, CRI>90 oder Full Spectrum. Fußplatte aus Stahl. 4m Anschlusskabel mit länderspezifischem Stecker (EU, CH, UK).

EN LED free-standing luminaire. Direct-indirect light distribution. Microprismatic screen with optimized glare reduction especially for workplaces. Luminaire head with perfect uniform and enhanced light transmission. High-quality pantograph with precision aluminium joints. No visible cables, springs or cords. Surface available in white, silver, black or champagne coated. Further surface options see Lightnet-Surface-Collection or RAL of your choice. Intuitive control panel in luminaire pole for dimming and switching the direct/indirect light separately, for Tunable White common control of the light chambers. Standard colour temperature 2700K, 3000K, 3500K, 4000K, 6500K or Tunable White (2700K-6500K). Binning \leq MacAdam 3. Colour rendering CRI>80, CRI>90 or Full Spectrum. Steel base plate, 4m power cable with country-specific plug (EU, CH, UK).

U S9 A W X - 8 30 H - D500 - P - A

Product Family	U: Grand Lucille
Type	S9: Direct-Indirect
Optical System	A: Microprismatic
Surface Finish	W: Snow White, A: Satin Silver, B: Jet Black, H: Anodic Champagne, K: Satin Copper
Control Gear	X: Separately Dimmable
Colour Rendering	8: CRI>80, 9: CRI>90, F: Full Spectrum
Colour Temperature	27: 2700K, 30: 3000K, 35: 3500K, 40: 4000K, 65: 6500K, TW: Tunable White 2700-6500K
Power	H: High Power
Size	Head Diameter in mm: D500
Base	P: Rectangular
Plug	A: Schuko CEE 7/7 (Type E+F), B: CH T12 (Type J), C: UK BS 1363 (Type G), D: Wieland, E: WAGO



Microprismatic | Direct-Indirect

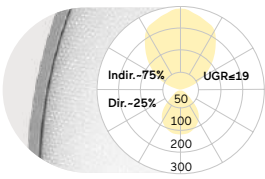

D mm	Lumen/Watt High Power
500	10700lm/80W

Lumen Values: Luminaire luminous flux at 4000K/CRI>80. Other configurations on request.

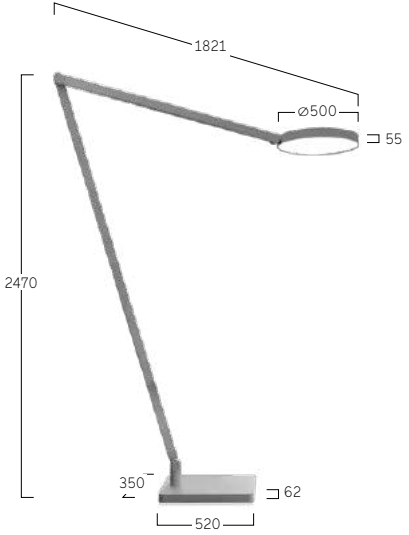

Separately Dimmable



W Snow White



A Satin Silver



U Urban Graphite



B Jet Black



H Anodic Champagne



K Satin Copper

Lucille S1 | Floor





Private Residence, Cologne, Germany
Lucille-S1



Lucille S1 | Floor



DE LED-Stehleuchte. Direktstrahlend. Microprismenoptik aus Acrylglas für optimierte Entblendung und Lichtlenkung. Höchstmöglicher Transmissionsgrad bei gleichmäßiger Ausleuchtung der relevanten Arbeitsflächen. Minimalistischer Leuchtenkopf mit perfekt homogener und vollflächiger Auflösung der Lichtpunkte. Hochwertiger Pantograf mit Präzisionsgelenken komplett aus Aluminium. Keine sichtbaren Kabel, Federn oder Seile. Oberfläche wahlweise weiß, silber, schwarz oder champagnerfarben lackiert. Intuitive Bedienung über Touchfeld im Leuchtenkopf. Lichtlevel stufenlos dimmbar. Standard Farbtemperatur 2700K, 3000K, 3500K, 4000K oder 6500K. Binning initial \leq MacAdam 3. Farbwiedergabe CRI $>$ 80, CRI $>$ 90 oder Full Spectrum. Fußplatte aus Stahl.

EN LED free-standing luminaire. Direct only light distribution. Microprismatic screen made of acrylic glass for optimised glare control and light direction. Highest possible transmittance with homogeneous illumination of the relevant work areas. Minimalistic luminaire head with perfect uniform and enhanced light transmission. High-quality with precision aluminium joints. No visible cables, springs or cords. Surface available in white, silver, black or champagne coated. Intuitive control via touch control panel in the luminaire head. Light output level continuously dimmable. Standard colour temperature 2700K, 3000K, 3500K, 4000K or 6500K. Binning \leq MacAdam 3. Colour rendering CRI $>$ 80, CRI $>$ 90 or Full Spectrum. Steel Base plate.

US1 A A S - 8 3 0 M - D150 - P

Product Family	U: Lucille
Type	S1: Direct only
Optical System	A: Microprismatic
Surface Finish	V: Ivory White, A: Satin Silver, B: Jet Black, H: Anodic Champagne, K: Satin Copper
Control Gear	S: Switch & Dimm
Colour Rendering	8: CRI>80, 9: CRI>90, F: Full Spectrum
Colour Temperature	27: 2700K, 30: 3000K, 35: 3500K, 40: 4000K, 65: 6500K
Power	M: Medium Power
Size	Head Diameter in mm: D150
Base	P: Rectangular



Microprismatic | Direct

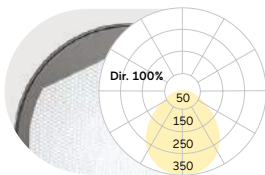

D mm	Lumen/Watt Medium Power
150	1000lm/13W

Lumen Values: Luminaire luminous flux at 4000K/CRI>80. Other configurations on request.

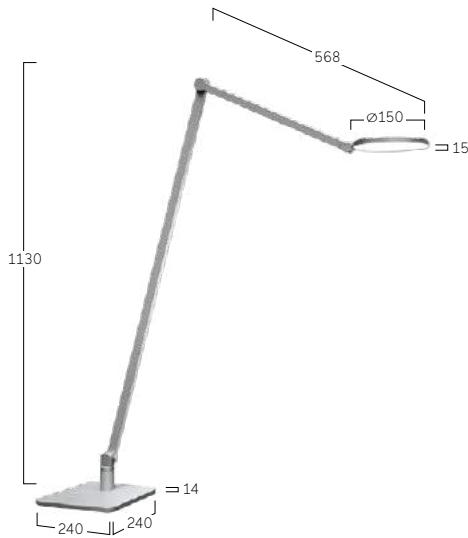

V Ivory White



A Satin Silver



B Jet Black



H Anodic Champagne



K Satin Copper

Basic Neo Floor



Joom Office
(project released in 2021)
Basic F4

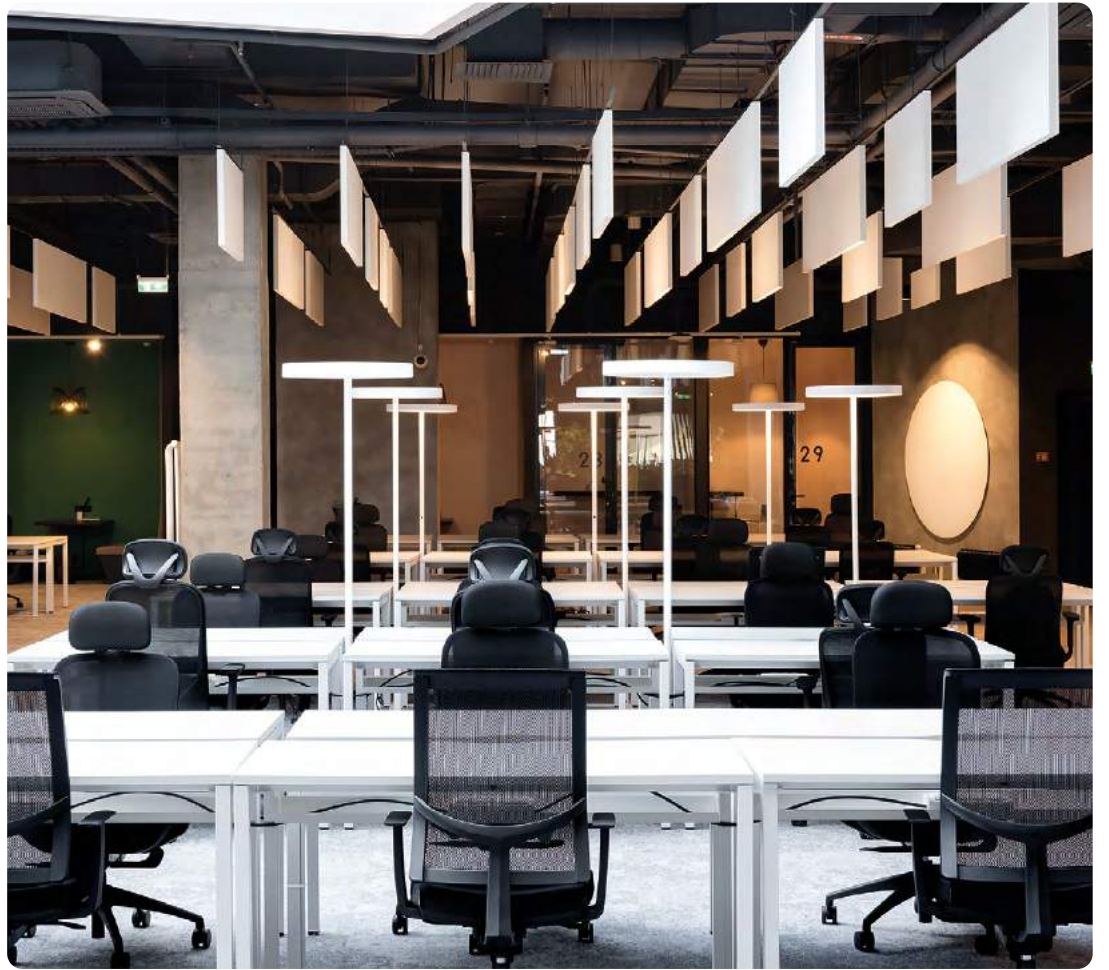

Basic Neo S2 | Floor



DE LED-Stehleuchte. Direkt-indirektstrahlend. Leuchtenkopf aus Aluminiumprofil mit filigraner Bauhöhe von 38mm und Durchmesser 500mm. Oberfläche weiß, silber, graphit, schwarz, champagner oder kupferfarben lackiert. Weitere Oberflächenoptionen siehe Lightnet-Surface-Collection oder RAL nach Wahl. Microprismenoptik mit optimierter Blendungsbegrenzung speziell für Office-Anwendungen. Intuitives Bedienfeld im Leuchtenmast für getrennt stufenlose Dimmung und Schaltung der Kammern für Direkt-/Indirektlicht, bei Tunable White oder Integration von Multisensor- oder Schwarmtechnologie gemeinsame Steuerung der Lichtkammern. Optional: HCL-Control für automatisches, dem Tagesverlauf angepasstes, biodynamisches Licht. Farbtemperatur 2700K, 3000K, 3500K, 4000K, 6500K oder Tunable White (2700-6500K). Binning initial \leq MacAdam 3. Farbwiedergabe CRI>80, CRI>90 oder Full Spectrum. Runde Fußplatte aus Stahl mit U-Cut-Out, Lackierung passend Leuchtenkörper. 4m Anschlusskabel mit länderspezifischem Stecker (EU, CH, UK).

EN LED free-standing luminaire. Direct-indirect light distribution. Luminaire head made of aluminium profile with slender overall height of 38mm and diameter of 500mm. Surface white, silver, graphite, black, champagne or copper coated. Further surface options see Lightnet-Surface-Collection or RAL of your choice. Microprismatic screen with optimized glare reduction especially for workplaces. Intuitive pole mounted control panel for dimming and switching the direct/indirect light separately, joint control of the light chambers with Tunable White or integration of multi-sensor or swarm technology. Optional: HCL Control for automatic, time dependent, biodynamic lighting. Colour temperature 2700K, 3000K, 3500K, 4000K, 6500K or Tunable White (2700-6500K). Binning \leq MacAdam 3. Colour rendering CRI>80, CRI>90 or Full Spectrum. Round steel base plate with U-Cut-Out, colour matching luminaire body. 4m power cable with country-specific plug (EU, CH, UK).

B S2 A S X - 8 30 M - D500 - U - A

Product Family	B: Basic
Type	S2: Direct-Indirect
Optical System	A: Microprismatic
Surface Finish	W: Snow White, V: Ivory White, S: Radiant Silver, U: Urban Graphite, B: Jet Black, H: Anodic Champagne, K: Satin Copper
Control Gear	X: Separately Dimmable, M: Multisensor, R: Swarm Control, B: HCL
Colour Rendering	8: CRI>80, 9: CRI>90, F: Full Spectrum
Colour Temperature	27: 2700K, 30: 3000K, 35: 3500K, 40: 4000K, 65: 6500K, TW: Tunable White 2700-6500K
Power	M: Medium Power
Size	Head Diameter in mm: D500
Base	U: U-Cut-Out, O: Round Base
Plug	A: Schuko CEE 7/7 (Type E+F), B: CH T12 (Type J), C: UK BS 1363 (Type G), D: Wieland, E: WAGO



Microprismatic | Direct-Indirect

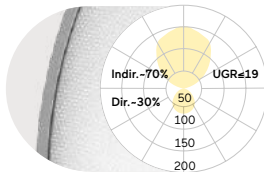

D	Lumen/Watt
mm	Medium Power
500	11700lm/81W

Lumen Values: Luminaire luminous flux at 4000K/CRI>80. Other configurations on request.



Multisensor/HCL/Swarm Control



Separately Dimmable



W Snow White



S Radiant Silver



U Urban Graphite



B Jet Black



H Anodic Champagne



K Satin Copper

Basic Neo S4 | Floor



DE LED-Stehleuchte. Direkt-indirektstrahlend. Leuchtenkopf aus Aluminiumprofil mit filigraner Bauhöhe von 38mm und Durchmesser 600mm. Oberfläche weiß, silber, graphit, schwarz, champagner oder kupferfarben lackiert. Weitere Oberflächenoptionen siehe Lightnet-Surface-Collection oder RAL nach Wahl. Microprismenoptik mit optimierter Blendungsbegrenzung speziell für Office-Anwendungen. Intuitives Bedienfeld im Leuchtenmast für getrennt stufenlose Dimmung und Schaltung der Kammern für Direkt-/Indirektlicht, bei Tunable White oder Integration von Multisensor- oder Schwarmtechnologie gemeinsame Steuerung der Lichtkammern. Optional: HCL-Control für automatisches, dem Tagesverlauf angepasstes, biodynamisches Licht. Farbtemperatur 2700K, 3000K, 3500K, 4000K, 6500K oder Tunable White (2700-6500K). Binning initial \leq MacAdam 3. Farbwiedergabe CRI $>$ 80, CRI $>$ 90 oder Full Spectrum. Runde Fußplatte aus Stahl, Lackierung passend Leuchtenkörper. 4m Anschlusskabel mit länderspezifischem Stecker (EU, CH, UK).

EN LED free-standing luminaire. Direct-indirect light distribution. Luminaire head made of aluminium profile with slender overall height of 38mm and diameter of 600mm. Surface white, silver, graphite, black, champagne or copper coated. Further surface options see Lightnet-Surface-Collection or RAL of your choice. Microprismatic screen with optimized glare reduction especially for workplaces. Intuitive pole mounted control panel for dimming and switching the direct/indirect light separately, joint control of the light chambers with Tunable White or integration of multi-sensor or swarm technology. Optional: HCL Control for automatic, time dependent, biodynamic lighting. Colour temperature 2700K, 3000K, 3500K, 4000K, 6500K or Tunable White (2700-6500K). Binning \leq MacAdam 3. Colour rendering CRI $>$ 80, CRI $>$ 90 or Full Spectrum. Round steel base plate, colour matching luminaire body. 4m power cable with country-specific plug (EU, CH, UK).

B S4 A S X - 8 30 M - D600 - O - A

Product Family	B: Basic
Type	S4: Direct-Indirect
Optical System	A: Microprismatic
Surface Finish	W: Snow White, V: Ivory White, S: Radiant Silver, U: Urban Graphite, B: Jet Black, H: Anodic Champagne, K: Satin Copper
Control Gear	X: Separately Dimmable, M: Multisensor, R: Swarm Control, B: HCL
Colour Rendering	8: CRI>80, 9: CRI>90, F: Full Spectrum
Colour Temperature	27: 2700K, 30: 3000K, 35: 3500K, 40: 4000K, 65: 6500K, TW: Tunable White 2700-6500K
Power	M: Medium Power
Size	Head Diameter in mm: D600
Base	O: Round Base
Plug	A: Schuko CEE 7/7 (Type E+F), B: CH T12 (Type J), C: UK BS 1363 (Type G), D: Wieland, E: WAGO



Microprismatic | Direct-Indirect

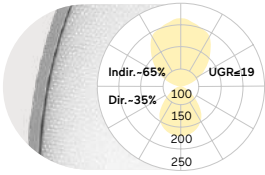

D	Lumen/Watt
mm	Medium Power
600	12700lm/88W

Lumen Values: Luminaire luminous flux at 4000K/CRI>80. Other configurations on request.

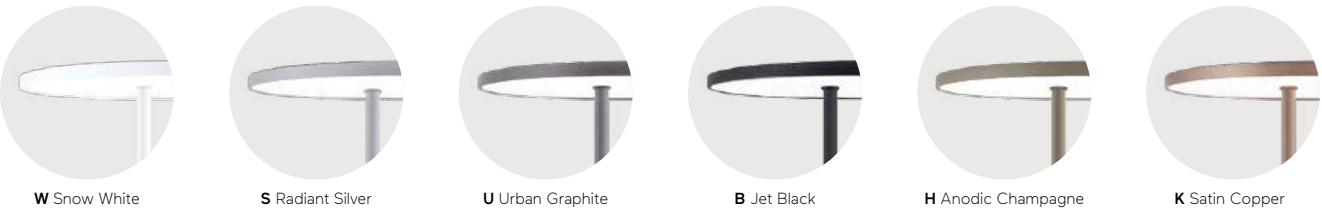
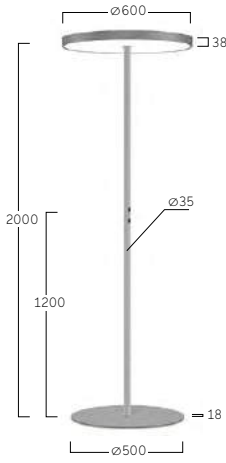

Basic Déco S3 | Floor



DE LED-Stehleuchte. Direkt-indirektstrahlend. Leuchtenkopf aus Aluminiumprofil mit Bauhöhe 58mm und Durchmesser 500mm. Gehäuse-Außenfläche und dekorativer Reflektorring in unterschiedlichen Lackierungen und Kombinationen erhältlich, z.B. weiß, silber, graphit, schwarz, gold oder kupferfarben. Zu Oberflächenoptionen- und Kombinationen siehe Lightnet-Surface-Collection oder Bi-Colour-Auswahl. Rückversetzte Microprismenoptik mit optimierter Blendungsbegrenzung speziell für Office-Anwendungen. Intuitives Bedienfeld im Leuchtenmast für getrennt stufenlose Dimmung und Schaltung der Kammern für Direkt-/Indirektlicht, bei Tunable White oder Integration von Multisensor- oder Schwarmtechnologie gemeinsame Steuerung der Lichtkammern. Optional: HCL-Control für automatisches, dem Tagesverlauf angepasstes, biodynamisches Licht. Farbtemperatur 2700K, 3000K, 3500K, 4000K, 6500K oder Tunable White (2700-6500K). Binning initial \leq MacAdam 3. Farbwiedergabe CRI>80, CRI>90 oder Full Spectrum. Runde Fußplatte aus Stahl mit U-Cut-Out, Lackierung passend Leuchtenkörper. 4m Anschlusskabel mit länderspezifischem Stecker (EU, CH, UK).

EN LED free-standing luminaire. Direct-indirect light distribution. Aluminium luminaire head with overall height of 58mm and diameter of 500mm. Outer housing and Decorative reflector ring available in various finishes and combinations, e.g. white, silver, graphite, black, gold or copper coated. Further surface options see Lightnet-Surface-Collection or RAL of your choice. Recessed microprismatic screen with optimized glare reduction especially for workplaces. Intuitive pole mounted control panel for dimming and switching the direct/indirect light separately, joint control of the light chambers with Tunable White or integration of multi-sensor or swarm technology. Optional: HCL Control for automatic, time dependent, biodynamic lighting. Colour temperature 2700K, 3000K, 3500K, 4000K, 6500K or Tunable White (2700-6500K). Binning \leq MacAdam 3. Colour rendering CRI>80, CRI>90 or Full Spectrum. Round steel base plate with U-Cut-Out, colour matching luminaire body. 4m power cable with country-specific plug (EU, CH, UK).

B S3 A S X-830 M-D500-UG-A

Product Family	B: Basic
Type	S3: Direct-Indirect
Optical System	A: Microprismatic
Surface Finish	W: Snow White, V: Ivory White, S: Radiant Silver, U: Urban Graphite, B: Jet Black, H: Anodic Champagne, K: Satin Copper
Control Gear	X: Separately Dimmable, M: Multisensor, R: Swarm Control, B: HCL
Colour Rendering	8: CRI>80, 9: CRI>90, F: Full Spectrum
Colour Temperature	27: 2700K, 30: 3000K, 35: 3500K, 40: 4000K, 65: 6500K, TW: Tunable White 2700-6500K
Power	M: Medium Power
Size	Head Diameter in mm: D500
Base	U: U-Cut-Out, O: Round Base
Reflector	W: Snow White, V: Ivory White, S: Radiant Silver, U: Urban Graphite, B: Jet Black, H: Anodic Champagne, K: Satin Copper, G: Satin Gold
Plug	A: Schuko CEE 7/7 (Type E+F), B: CH T12 (Type J), C: UK BS 1363 (Type G), D: Wieland, E: WAGO



Microprismatic | Direct-Indirect

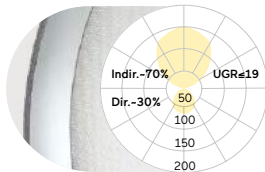

D mm	Lumen/Watt Medium Power
500	11700lm/81W

Lumen Values: Luminaire luminous flux at 4000K/CRI>80. Other configurations on request.

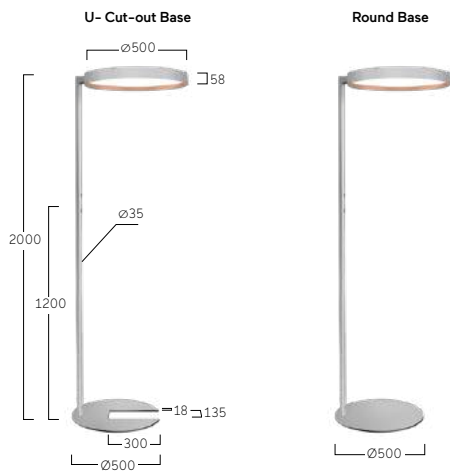

Separately Dimmable



Multisensor/HCL /Swarm Control



W Snow White
W Snow White



S Radiant Silver
S Radiant Silver



U Urban Graphite
U Urban Graphite



B Jet Black
B Jet Black



H Anodic Champagne
H Anodic Champagne



K Satin Copper
K Satin Copper



W Snow White
K Satin Copper

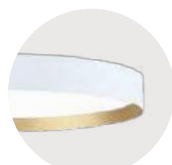

W Snow White
G Satin Gold



W Snow White
B Jet Black



H Anodic Champagne
B Jet Black



B Jet Black
G Satin Gold

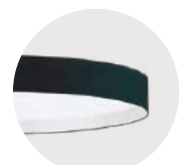

B Jet Black
W Snow White

Basic Déco S5 | Floor



DE LED-Stehleuchte. Direkt-indirektstrahlend. Leuchtenkopf aus Aluminiumprofil mit Bauhöhe 58mm und Durchmesser 600mm. Gehäuse-Außenfläche und dekorativer Reflektorring in unterschiedlichen Lackierungen und Kombinationen erhältlich, z.B. weiß, silber, graphit, schwarz, gold oder kupferfarben. Zu Oberflächenoptionen- und Kombinationen siehe Lightnet-Surface-Collection oder Bi-Colour-Auswahl. Rückversetzte Microprismenoptik mit optimierter Blendungsbegrenzung speziell für Office-Anwendungen. Intuitives Bedienfeld im Leuchtenmast für getrennt stufenlose Dimmung und Schaltung der Kammern für Direkt-/Indirektlicht, bei Tunable White oder Integration von Multisensor- oder Schwarmtechnologie gemeinsame Steuerung der Lichtkammern. Farbtemperatur 2700K, 3000K, 3500K, 4000K, 6500K oder Tunable White (2700-6500K). Binning initial \leq MacAdam 3. Farbwiedergabe CRI $>$ 80, CRI $>$ 90 oder Full Spectrum. Runde Fußplatte aus Stahl, Lackierung passend Leuchtenkörper. 4m Anschlusskabel mit länderspezifischem Stecker (EU, CH, UK).

EN LED free-standing luminaire. Direct-indirect light distribution. Luminaire head is made of aluminium profile with overall height of 58mm and diameter of 600mm. Outer housing and Decorative reflector ring available in various finishes and combinations, e.g. white, silver, graphite, black, gold or copper coated. Further surface options see Lightnet-Surface-Collection or RAL of your choice. Recessed microprismatic screen with optimized glare reduction especially for workplaces. Intuitive pole mounted control panel for dimming and switching the direct/indirect light separately, joint control of the light chambers with Tunable White or integration of multi-sensor or swarm technology. Colour temperature 2700K, 3000K, 3500K, 4000K, 6500K or Tunable White (2700-6500K). Binning \leq MacAdam 3. Colour rendering CRI $>$ 80, CRI $>$ 90 or Full Spectrum. Round steel base plate, colour matching luminaire body. 4m power cable with country-specific plug (EU, CH, UK).

B S5 A SX-8 30 M-D600-OG-A

Product Family	B: Basic
Type	S5: Direct-Indirect
Optical System	A: Microprismatic
Surface Finish	W: Snow White, V: Ivory White, S: Radiant Silver, U: Urban Graphite, B: Jet Black, H: Anodic Champagne, K: Satin Copper
Control Gear	X: Separately Dimmable, M: Multisensor, R: Swarm Control, B: HCL
Colour Rendering	8: CRI>80, 9: CRI>90, F: Full Spectrum
Colour Temperature	27: 2700K, 30: 3000K, 35: 3500K, 40: 4000K, 65: 6500K, TW: Tunable White 2700-6500K
Power	M: Medium Power
Size	Head Diameter in mm: D600
Base	O: Round Base
Reflector	W: Snow White, V: Ivory White, S: Radiant Silver, U: Urban Graphite, B: Jet Black, H: Anodic Champagne, K: Satin Copper, G: Satin Gold
Plug	A: Schuko CEE 7/7 (Type E+F), B: CH T12 (Type J), C: UK BS 1363 (Type G), D: Wieland, E: WAGO



Microprismatic | Direct-Indirect

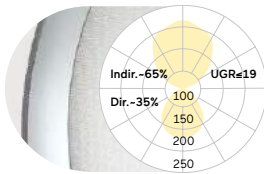

D	Lumen/Watt
mm	Medium Power
600	12700lm/88W

Lumen Values: Luminarie luminous flux at 4000K/CRI>80. Other configurations on request.

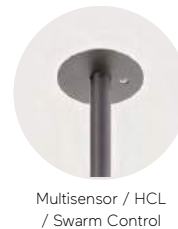
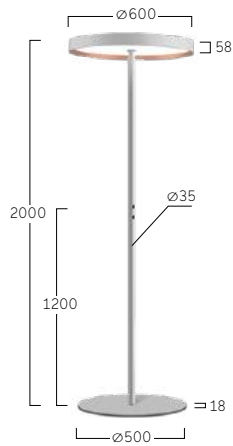

W Snow White
W Snow White



S Radiant Silver
S Radiant Silver



U Urban Graphite
U Urban Graphite



B Jet Black
B Jet Black



H Anodic Champagne
H Anodic Champagne



K Satin Copper
K Satin Copper

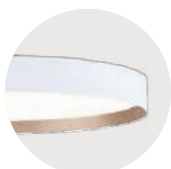

W Snow White
K Satin Copper

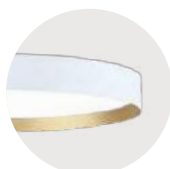

W Snow White
G Satin Gold



W Snow White
B Jet Black



H Anodic Champagne
B Jet Black

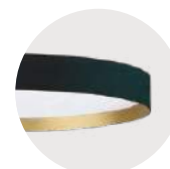

B Jet Black
G Satin Gold

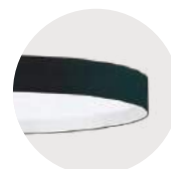

B Jet Black
W Snow White

Beam Me Up S1 | Mini Floor



DE LED-Stehleuchte mit rückversetzter Optik und dekorativem Reflektorring. Direkt-indirektstrahlend. Leuchterschirm aus hochwertig verarbeitetem Fiberglas. Gehäuse-Außenfläche und dekorativer Reflektorring in unterschiedlichen Lackierungen und Kombinationen erhältlich, z.B. weiß, silber, graphit, schwarz, gold oder kupferfarben lackiert. Zu Oberflächenoptionen- und Kombinationen siehe Lightnet-Surface-Collection oder Bi-Colour-Auswahl. Microprismenoptik mit optimierter Blendungsbegrenzung speziell für Office-Anwendungen. Satiniertes Opaldiffusor für Allgemeinbeleuchtung mit max. Transmissionsgrad und homogener Lichtpunktauflösung. Intuitives Bedienfeld im Leuchtenmast für getrennt stufenlose Dimmung und Schaltung der Kammern für Direkt-/Indirektlicht. Farbtemperatur 2200K, 2700K, 3000K, 3500K, 4000K oder 6500K. Binning initial \leq MacAdam 3. Farbwiedergabe CRI $>$ 80, CRI $>$ 90 oder Full Spectrum. Fußplatte aus Stahl, Lackierung passend Leuchtenkörper. 4m Anschlusskabel mit länderspezifischem Stecker (EU, CH, UK).

EN LED free-standing luminaire with a rebated lens optic in a Decorative ring. Direct-indirect light distribution. Luminaire shade made of high-quality processed fiberglass. Outer housing and Decorative reflector ring available in various finishes and combinations, e.g. white, silver, graphite, black, gold or copper coated. Further surface options see Lightnet-Surface-Collection or RAL of your choice. Microprismatic screen with optimized glare reduction especially for workplaces. Satin opal diffuser for general lighting with maximum transmittance and homogeneous lighting. Intuitive control panel in luminaire pole for dimming and switching the direct/indirect light separately. Colour temperature 2200K, 2700K, 3000K, 3500K, 4000K or 6500K. Binning \leq MacAdam 3. Colour rendering CRI $>$ 80, CRI $>$ 90 or Full Spectrum. Base plate made of steel, colour matching luminaire body. 4m power cable with country-specific plug (EU, CH, UK).

MS1 A B X-8 30M-D450-CG-A

Product Family	M: Beam Me Up
Type	S1: Direct-Indirect
Optical System	A: Microprismatic, O: Opal Diffuser
Surface Finish	W: Snow White, V: Ivory White, A: Satin Silver, U: Urban Graphite, B: Jet Black, H: Anodic Champagne, K: Satin Copper
Control Gear	X: Separately Dimmable
Colour Rendering	8: CRI>80, 9: CRI>90, F: Full Spectrum [except 2200K]
Colour Temperature	22: 2200K, 27: 2700K, 30: 3000K, 35: 3500K, 40: 4000K, 65: 6500K
Power	M: Medium Power
Size	Head Diameter in mm: D450
Base	C: Square with Soft Corners
Reflector	W: Snow White, V: Ivory White, A: Satin Silver, U: Urban Graphite, B: Jet Black, H: Anodic Champagne, K: Satin Copper, G: Satin Gold
Plug	A: Schuko CEE 7/7 (Type E+F), B: CH T12 (Type J), C: UK BS 1363 (Type G), D: Wieland, E: WAGO



Microprismatic | Direct-Indirect

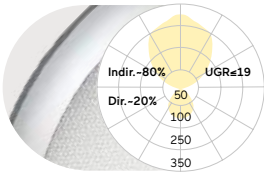

D	Lumen/Watt
mm	Medium Power
450	9050lm/74W

Opal Diffuser | Direct-Indirect

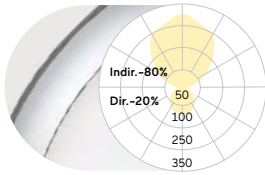

D	Lumen/Watt
mm	Medium Power
450	9050lm/74W

Lumen Values: Luminaire luminous flux at 4000K/CRI>80. Other configurations on request.

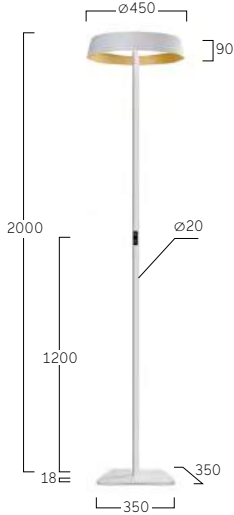

Separately Dimmable



W Snow White
G Satin Gold



W Snow White
K Satin Copper



A Satin Silver
B Jet Black



B Jet Black
A Satin Silver



B Jet Black
G Satin Gold



B Jet Black
H Anodic Champagne

Beam Me Up S4 | Floor



DE LED-Stehleuchte mit rückversetzter Optik und dekorativem Reflektoring. Direkt-indirektstrahlend. Leuchterschirm aus hochwertig verarbeitetem Fiberglas. Gehäuse-Außenfläche und Innendekor in unterschiedlichen Lackierungen und Kombinationen erhältlich, z.B. weiß, silber, graphit, schwarz, gold oder kupferfarben lackiert. Zu Oberflächenoptionen- und Kombinationen siehe Lightnet-Surface-Collection oder Bi-Colour-Auswahl. Microprismenoptik mit optimierter Blendungsbegrenzung speziell für Office-Anwendungen. Satiniertes Opaldiffusor für Allgemeinbeleuchtung mit max. Transmissionsgrad und homogener Lichtpunktauflösung. Intuitives Bedienfeld im Leuchtenmast für getrennt stufenlose Dimmung und Schaltung der Kammern für Direkt-/Indirektlicht, bei Tunable White oder Integration von Multisensor- oder Schwarmtechnologie gemeinsame Steuerung der Lichtkammern. Optional: HCL-Control für automatisches, dem Tagesverlauf angepasstes, biodynamisches Licht. Farbtemperatur 2200K, 2700K, 3000K, 3500K, 4000K, 6500K oder Tunable White (2700-6500K). Binning initial \leq MacAdam 3. Farbwiedergabe CRI $>$ 80, CRI $>$ 90 oder Full Spectrum. Fußplatte aus Stahl, Lackierung passend Leuchtenkörper. 4m Anschlusskabel mit länderspezifischem Stecker (EU, CH, UK).

EN LED free-standing luminaire with a rebated lens optic in a Decorative ring. Direct-indirect light distribution. Luminaire shade made of high-quality processed fiberglass. Outer housing and inner decor available in various finishes and combinations, e.g. white, silver, graphite, black, gold or copper coated. Further surface options see Lightnet-Surface-Collection or RAL of your choice. Microprismatic screen with optimized glare reduction especially for workplaces. Satin opal diffuser for general lighting with maximum transmittance and homogeneous lighting. Intuitive control panel in luminaire pole for dimming and switching the direct/indirect light separately, joint control of the light chambers with Tunable White or integration of multi-sensor or swarm technology. Optional: HCL Control for automatic, time dependent, biodynamic lighting. Colour temperature 2200K, 2700K, 3000K, 3500K, 4000K, 6500K or Tunable White (2700-6500K). Binning \leq MacAdam 3. Colour rendering CRI $>$ 80, CRI $>$ 90 or Full Spectrum. Base plate made of steel, colour matching luminaire body. 4m power cable with country-specific plug (EU, CH, UK).

MS4 A B X-8 30 M-D650-CG-A

Product Family	M: Beam Me Up
Type	S4: Direct-Indirect
Optical System	A: Microprismatic, O: Opal Diffuser
Surface Finish	W: Snow White, V: Ivory White, A: Satin Silver, U: Urban Graphite, B: Jet Black, H: Anodic Champagne, K: Satin Copper
Control Gear	X: Separately Dimmable, M: Multisensor, R: Swarm Control, B: HCL
Colour Rendering	8: CRI>80, 9: CRI>90, F: Full Spectrum [except 2200K]
Colour Temperature	22: 2200K, 27: 2700K, 30: 3000K, 35: 3500K, 40: 4000K, 65: 6500K, TW: Tunable White 2700-6500K
Power	M: Medium Power
Size	Head Diameter in mm: D650
Base	C: Square with Soft Corners
Reflector	W: Snow White, V: Ivory White, A: Satin Silver, U: Urban Graphite, B: Jet Black, H: Anodic Champagne, K: Satin Copper, G: Satin Gold
Plug	A: Schuko CEE 7/7 (Type E+F), B: CH T12 (Type J), C: UK BS 1363 (Type G), D: Wieland, E: WAGO



Microprismatic | Direct-Indirect

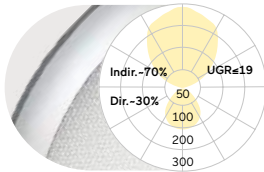

D	Lumen/Watt
mm	Medium Power
650	11900lm/93W

Opal Diffuser | Direct-Indirect

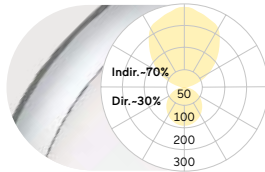

D	Lumen/Watt
mm	Medium Power
650	12000lm/93W

Lumen Values: Luminaire luminous flux at 4000K/CRI>80. Other configurations on request.

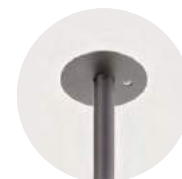
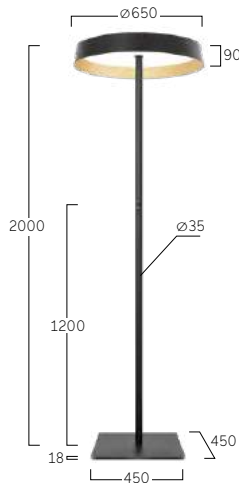

Multisensor / HCL / Swarm Control



Separately Dimmable



W Snow White
G Satin Gold



W Snow White
K Satin Copper



A Satin Silver
B Jet Black



B Jet Black
A Satin Silver



B Jet Black
G Satin Gold



B Jet Black
H Anodic Champagne

Beam Me Up S6 | Floor



DE LED-Stehleuchte mit rückversetzter Optik und Innendekor. Direkt-indirektstrahlend. Leuchterschirm aus hochwertig verarbeitetem Fiberglas. Gehäuse-Außenfläche und dekorativer Reflektorring in unterschiedlichen Lackierungen und Kombinationen erhältlich, z.B. weiß, silber, graphit, schwarz, gold oder kupferfarben lackiert. Zu Oberflächenoptionen- und Kombinationen siehe Lightnet-Surface-Collection oder Bi-Colour-Auswahl. Microprismenoptik mit optimierter Blendungsbegrenzung speziell für Office-Anwendungen. Satinierter Opaldiffusor für Allgemeinbeleuchtung mit max. Transmissionsgrad und homogener Lichtpunktauflösung. Intuitives Bedienfeld im Leuchtenmast für getrennt stufenlose Dimmung und Schaltung der Kammern für Direkt-/Indirektlicht, bei Tunable White gemeinsame Steuerung der Lichtkammern. Farbtemperatur 2200K, 2700K, 3000K, 3500K, 4000K, 6500K oder Tunable White (2700-6500K). Binning initial \leq MacAdam 3. Farbwiedergabe CRI $>$ 80, CRI $>$ 90 oder Full Spectrum. Fußplatte aus Stahl, Lackierung passend Leuchtenkörper. 4m Anschlusskabel mit länderspezifischem Stecker (EU, CH, UK).

EN LED free-standing luminaire with rebated lens optic and inner decor. Direct-indirect light distribution. Luminaire shade made of high-quality processed fiberglass. Outer housing and Decorative reflector ring available in various finishes and combinations, e.g. white, silver, graphite, black, gold or copper coated. Further surface options see Lightnet-Surface-Collection or RAL of your choice. Microprismatic screen with optimized glare reduction especially for workplaces. Satin opal diffuser for general lighting with maximum transmittance and homogeneous lighting. Intuitive control panel in luminaire pole for dimming and switching the direct/indirect light separately, for Tunable White common control of the light chambers. Colour temperature 2200K, 2700K, 3000K, 3500K, 4000K, 6500K or Tunable White (2700-6500K). Binning \leq MacAdam 3. Colour rendering CRI $>$ 80, CRI $>$ 90 or Full Spectrum. Base plate made of steel, colour matching luminaire body. 4m power cable with country-specific plug (EU, CH, UK).

M S6 A B X-8 30M-D650-UG-A

Product Family	M: Beam Me Up
Type	S6: Direct-Indirect
Optical System	A: Microprismatic, O: Opal Diffuser
Surface Finish	W: Snow White, V: Ivory White, A: Satin Silver, U: Urban Graphite, B: Jet Black, H: Anodic Champagne, K: Satin Copper
Control Gear	X: Separately Dimmable
Colour Rendering	8: CRI>80, 9: CRI>90, F: Full Spectrum [except 2200K]
Colour Temperature	22: 2200K, 27: 2700K, 30: 3000K, 35: 3500K, 40: 4000K, 65: 6500K, TW: Tunable White 2700-6500K
Power	M: Medium Power
Size	Head Diameter in mm: D650
Base	U: U-Cut-Out, C: Square with Soft Corners
Reflector	W: Snow White, V: Ivory White, A: Satin Silver, U: Urban Graphite, B: Jet Black, H: Anodic Champagne, K: Satin Copper, G: Satin Gold
Plug	A: Schuko CEE 7/7 (Type E+F), B: CH T12 (Type J), C: UK BS 1363 (Type G), D: Wieland, E: WAGO



Microprismatic | Direct-Indirect

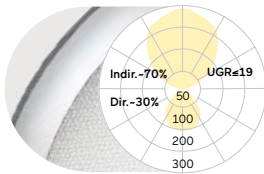

D	Lumen/Watt
mm	Medium Power
650	11900lm/93W

Opal Diffuser | Direct

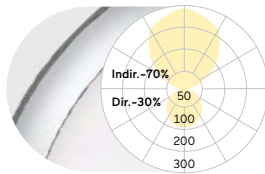

D	Lumen/Watt
mm	Medium Power
650	12000lm/93W

Lumen Values: Luminaire luminous flux at 4000K/CRI>80. Other configurations on request.

Square with Soft Corners

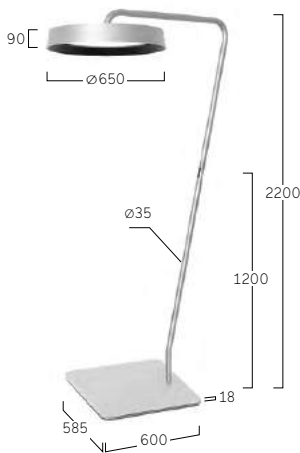

U- Cut-out Base



Separately Dimmable



W Snow White
G Satin Gold



W Snow White
K Satin Copper



A Satin Silver
B Jet Black



B Jet Black
A Satin Silver



B Jet Black
G Satin Gold



B Jet Black
H Anodic Champagne

Liquid Line SX | System 40mm Floor One Head



DE LED-Stehleuchte. Direkt- indirektstrahlend. Leuchtenkopf mit feinen Radien aus Aluminium, gefertigt aus einem Guss ohne sichtbare Nahtstellen an den Stirnseiten. Oberfläche weiß, silber, graphit, schwarz, champagner oder kupferfarben lackiert. Weitere Oberflächenoptionen siehe Lightnet-Surface-Collection oder RAL nach Wahl. Direktanteil über Präzisionslinsen mit Abblenderaster für breite rotationsymmetrische Lichtstärkeverteilung bei gleichzeitig hoher Blendungsbegrenzung (UGR<19). Abblenderaster in verschiedenen Farbkombinationen erhältlich. Intuitives Bedienfeld im Leuchtenmast für getrennt stufenlose Dimmung und Schaltung der Kammern für Direkt-/Indirektlicht, bei Tunable White oder Integration von Multisensor- oder Schwarmtechnologie gemeinsame Steuerung der Lichtkammern. Optional: HCL Control für automatische, tageszeitabhängige, biodynamische Farbtemperaturanpassung. Farbtemperatur 2700K, 3000K, 3500K, 4000K, 6500K oder Tunable White (2700-6500K). Binning initial \leq MacAdam 3. Farbwiedergabe CRI>80, CRI>90 oder Full Spectrum. Fußplatte aus Stahl für unterschiedliche Tischausführungen, Lackierung passend Leuchtenkörper. 4m Anschlusskabel mit länderspezifischem Stecker (EU, CH, UK).

EN LED free-standing luminaire. Direct-indirect light distribution. Luminaire head with smooth curves made of aluminium, crafted in one piece with no visible seams. Surface white, silver, graphite, black, champagne or copper coated. Further surface options see Lightnet-Surface-Collection or RAL of your choice. Direct light using precision lenses with louvre for wide uniform symmetrical light distribution with high glare limitation (UGR<19). Louvre available in various colour finishes. Intuitive pole mounted control panel for dimming and switching the direct/indirect light separately, joint control of the light chambers with Tunable White or integration of multi-sensor or swarm technology. Optional: HCL Control for automatic, time dependent, biodynamic lighting. Colour temperature 2700K, 3000K, 3500K, 4000K, 6500K or Tunable White (2700-6500K). Binning \leq MacAdam 3. Colour rendering CRI>80, CRI>90 or Full Spectrum. Steel base plate for different table designs, colour matching luminaire body. 4m power cable with country-specific plug (EU, CH, UK).

Q SXL B X - 8 30 M - L1490 - UG - A

Product Family	Q: Liquid Line
Type	SX: Direct-Indirect
Optical System	L: Lens Louvre
Surface Finish	W: Snow White, V: Ivory White, A: Satin Silver, S: Radiant Silver, U: Urban Graphite, B: Jet Black, H: Anodic Champagne, K: Satin Copper
Control Gear	X: Separately Dimmable, M: Multisensor, R: Swarm Control, B: HCL
Colour Rendering	8: CRI>80, 9: CRI>90, F: Full Spectrum
Colour Temperature	27: 2700K, 30: 3000K, 35: 3500K, 40: 4000K, 65: 6500K, TW: Tunable White 2700-6500K
Power	M: Medium Power
Size	Head Length in mm: L1490 [Separately Dimmable], L1590 [Multisensor, Swarm Control, HCL]
Base*	S: Side Cut-Out, U: U-Cut-Out, P: Rectangular
Lens Louvre	W: Snow White, B: Jet Black, A: Satin Silver, H: Anodic Champagne, K: Satin Copper, G: Satin Gold
Plug	A: Schuko CEE 7/7 (Type E+F), B: CH T12 (Type J), C: UK BS 1363 (Type G), D: Wieland, E: WAGO

*Bases with Soft Corners



Lens Louvre | Direct-Indirect

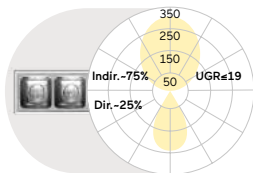

Power	Lumen/Watt
Medium Power	10300lm/85W

Lumen Values: Luminaire luminous flux at 4000K/CRI>80. Other configurations on request.

U- Cut-out Base

Side Cut-Out Base

Rectangular Base

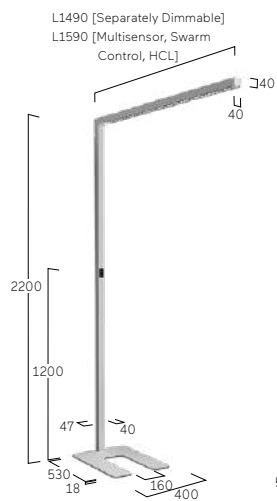

Multisensor / HCL / Swarm Control

Separately Dimmable



W Snow White
W Snow White



W Snow White
A Satin Silver



W Snow White
B Jet Black



W Snow White
H Anodic Champagne



W Snow White
K Satin Copper



W Snow White
G Satin Gold

Liquid Line SY | System 40mm Floor Two Heads



DE LED-Stehleuchte. Direkt- indirektstrahlend. Leuchtenkopf mit feinen Radien aus Aluminium, gefertigt aus einem Guss ohne sichtbare Nahtstellen an den Stirnseiten. Oberfläche weiß, silber, graphit, schwarz, champagner oder kupferfarben lackiert. Weitere Oberflächenoptionen siehe Lightnet-Surface-Collection oder RAL nach Wahl. Direktanteil über Präzisionslinsen mit Abblenderaster für breite rotationssymmetrische Lichtstärkeverteilung bei gleichzeitig hoher Blendungsbegrenzung (UGR<19). Abblenderaster in verschiedenen Farbkombinationen erhältlich. Intuitive Bedienfelder im Leuchtenmast für getrennt stufenlose Dimmung und Schaltung der Kammern für Direkt-/Indirektlicht je Leuchtenkopf, bei Tunable White oder Integration von Multisensor- oder Schwarmtechnologie gemeinsame Steuerung der Lichtkammern je Leuchtenkopf. Optional: HCL-Control für automatisches, dem Tagesverlauf angepasstes, biodynamisches Licht. Farbtemperatur 2700K, 3000K, 3500K, 4000K, 6500K oder Tunable White (2700-6500K). Binning initial \leq MacAdam 3. Farbwiedergabe CRI>80, CRI>90 oder Full Spectrum. Fußplatte aus Stahl für unterschiedliche Tischausführungen, Lackierung passend Leuchtenkörper. 4m Anschlusskabel mit länderspezifischem Stecker (EU, CH, UK).

EN LED free-standing luminaire. Direct-indirect light distribution. Luminaire head with smooth curves made of aluminium, crafted in one piece with no visible seams. Surface white, silver, graphite, black, champagne or copper coated. Further surface options see Lightnet-Surface-Collection or RAL of your choice. Direct light using precision lenses with louvre for wide uniform symmetrical light distribution with high glare limitation (UGR<19). Louvre available in various colour finishes. Intuitive pole mounted control panels for dimming and switching the direct/indirect light separately per luminaire head, joint control of the light chambers per luminaire head with Tunable White or integration of multi-sensor or swarm technology. HCL Control for automatic, time dependent, biodynamic lighting. Colour temperature 2700K, 3000K, 3500K, 4000K, 6500K or Tunable White (2700-6500K). Binning \leq MacAdam 3. Colour rendering CRI>80, CRI>90 or Full Spectrum. Steel base plate for different table designs, colour matching luminaire body. 4m power cable with country-specific plug (EU, CH, UK).

Q SYL B X - 8 30 M - L2940 - HG - A

Product Family	Q: Liquid Line
Type	SY: Direct-Indirect
Optical System	L: Lens Louvre
Surface Finish	W: Snow White, V: Ivory White, A: Satin Silver, S: Radiant Silver, U: Urban Graphite, B: Jet Black, H: Anodic Champagne, K: Satin Copper
Control Gear	X: Separately Dimmable, M: Multisensor, R: Swarm Control
Colour Rendering	8: CRI>80, 9: CRI>90, F: Full Spectrum
Colour Temperature	27: 2700K, 30: 3000K, 35: 3500K, 40: 4000K, 65: 6500K
Power	M: Medium Power
Size	Head Length in mm: L2940 [Separately Dimmable], L3140 [Multisensor, Swarm Control]
Base*	H: H-Cut-Out, P: Rectangular
Lens Louvre	W: Snow White, B: Jet Black, A: Satin Silver, H: Anodic Champagne, K: Satin Copper, G: Satin Gold
Plug	A: Schuko CEE 7/7 (Type E+F), B: CH T12 (Type J), C: UK BS 1363 (Type G), D: Wieland, E: WAGO

*Bases with Soft Corners



Lens Louvre | Direct-Indirect

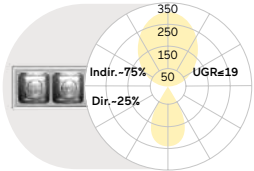

Power	Lumen/Watt
Medium Power	20600lm/170W

Lumen Values: Luminarie luminous flux at 4000K/CRI>80. Other configurations on request.

H- Cut-out Base

Rectangular Base

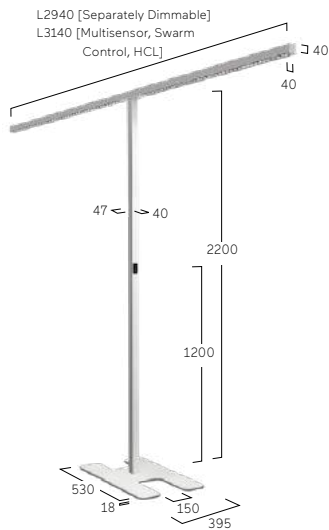

Multisensor / HCL / Swarm Control

Separately Dimmable



W Snow White
W Snow White



W Snow White
A Satin Silver



W Snow White
B Jet Black



W Snow White
H Anodic Champagne



W Snow White
K Satin Copper



W Snow White
G Satin Gold

Caleo Neo S2 | Floor



DE LED-Stehleuchte. Direkt-indirektstrahlend. Leuchtenkörper aus Aluminium mit filigraner Bauhöhe von 42mm. Gehäuse-Außenfläche und dekorativer Reflektorring in unterschiedlichen Lackierungen und Kombinationen erhältlich, z.B. weiß, silber, graphit, schwarz, gold oder kupferfarben. Zu Oberflächenoptionen- und Kombinationen siehe Lightnet-Surface-Collection oder Bi-Colour-Auswahl. Rückversetzte Microprismen optik mit optimierter Blendungsbegrenzung speziell für Office-Anwendungen bei vollständiger Lichtpunktauflösung. Intuitives Bedienfeld im Leuchtenmast für getrennt stufenlose Dimmung und Schaltung der Kammern für Direkt-/Indirektlicht. Farbtemperatur 2700K, 3000K, 3500K, 4000K oder 6500K. Binning initial \leq MacAdam 3. Farbwiedergabe CRI>80, CRI>90 oder Full Spectrum. Fußplatte aus Stahl, optional mit U- oder Side-Cut-Out für unterschiedliche Tischausführungen, Lackierung passend Leuchtenkörper. 4m Anschlusskabel mit länderspezifischem Stecker (EU, CH, UK).

EN LED free-standing luminaire. Direct-indirect light distribution. Luminaire body made of aluminium with slender overall height of 42mm. Outer housing and Decorative reflector ring available in various finishes and combinations, e.g. white, silver, graphite, black, gold or copper coated. Further surface options see Lightnet-Surface-Collection or RAL of your choice. Recessed microprismatic screen with optimized glare reduction especially for workplaces with uniform and enhanced light transmission. Intuitive pole mounted control panel for dimming and switching the direct/indirect light separately. Colour temperature 2700K, 3000K, 3500K, 4000K or 6500K. Binning \leq MacAdam 3. Colour rendering CRI>80, CRI>90 or Full Spectrum. Steel base plate, optionally with U- or Side Cut-Out for different table designs, colour matching luminaire body. 4m power cable with country-specific plug (EU, CH, UK).

A S2 A B X - 8 30 M - L600 - UG - A

Product Family	A: Caleo
Type	S2: Direct-Indirect
Optical System	A: Microprismatic
Surface Finish	W: Snow White, V: Ivory White, S: Radiant Silver, U: Urban Graphite, B: Jet Black, H: Anodic Champagne, K: Satin Copper, A: Satin Silver
Control Gear	X: Separately Dimmable
Colour Rendering	8: CRI>80, 9: CRI>90, F: Full Spectrum
Colour Temperature	27: 2700K, 30: 3000K, 35: 3500K, 40: 4000K, 65: 6500K
Power	M: Medium Power, H: High Power
Size	Head Length in mm: L600
Base*	S: Side Cut-Out, U: U-Cut-Out, P: Rectangular
Reflector	W: Snow White, V: Ivory White, S: Radiant Silver, U: Urban Graphite, B: Jet Black, H: Anodic Champagne, K: Satin Copper, G: Satin Gold
Plug	A: Schuko CEE 7/7 (Type E+F), B: CH T12 (Type J), C: UK BS 1363 (Type G), D: Wieland, E: WAGO

*Bases with Soft Corners



Microprismatic | Direct-Indirect

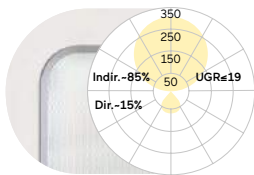

L	Lumen/Watt	Lumen/Watt
mm	Medium Power	High Power
600	11000lm/73W	14500lm/96W

Lumen Values: Luminaire luminous flux at 4000K/CRI>80. Other configurations on request.

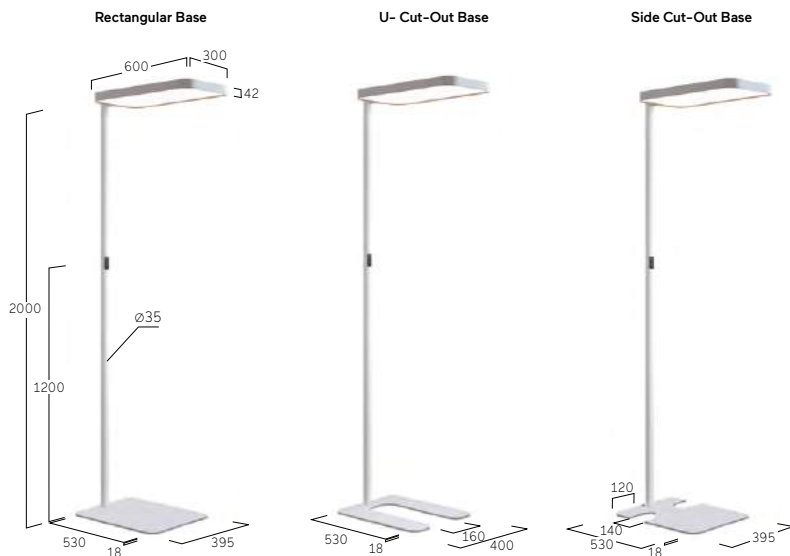

Separately Dimmable

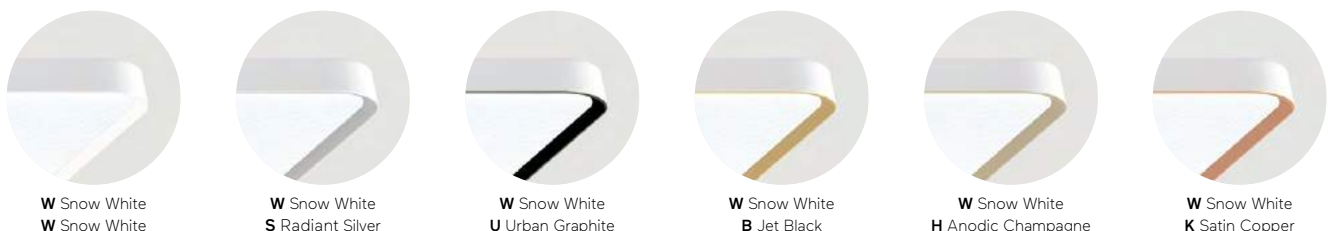

Caleo Neo S4 | Floor



DE LED-Stehleuchte. Direkt-indirektstrahlend. Leuchtenkörper aus Aluminium mit filigraner Bauhöhe von 42mm. Gehäuse-Außenfläche und dekorativer Reflektorring in unterschiedlichen Lackierungen und Kombinationen erhältlich, z.B. weiß, silber, graphit, schwarz, gold oder kupferfarben. Zu Oberflächenoptionen- und Kombinationen siehe Lightnet-Surface-Collection oder Bi-Colour-Auswahl. Rückversetzte Microprismenoptik mit optimierter Blendungsbegrenzung speziell für Office-Anwendungen bei vollständiger Lichtpunktauflösung. Intuitives Bedienfeld im Leuchtenmast für getrennt stufenlose Dimmung und Schaltung der Kammern für Direkt-/Indirektlicht. Farbtemperatur 2700K, 3000K, 3500K, 4000K oder 6500K. Binning initial \leq MacAdam 3. Farbwiedergabe CRI>80, CRI>90 oder Full Spectrum. Fußplatte aus Stahl, Lackierung passend Leuchtenkörper. 4m Anschlusskabel mit länderspezifischem Stecker (EU, CH, UK).

EN LED free-standing luminaire. Direct-indirect light distribution. Luminaire body made of aluminium with slender overall height of 42mm. Outer housing and Decorative reflector ring available in various finishes and combinations, e.g. white, silver, graphite, black, gold or copper coated. Further surface options see Lightnet-Surface-Collection or RAL of your choice. Recessed microprismatic screen with optimized glare reduction especially for workplaces with uniform and enhanced light transmission. Intuitive pole mounted control panel for dimming and switching the direct/indirect light separately. Colour temperature 2700K, 3000K, 3500K, 4000K or 6500K. Binning \leq MacAdam 3. Colour rendering CRI>80, CRI>90 or Full Spectrum. Steel Base plate, colour matching luminaire body. 4m power cable with country-specific plug (EU, CH, UK).

A S4 A B X - 8 30 M - Q600 - C G - A

Product Family	A: Caleo
Type	S4: Direct-Indirect
Optical System	A: Microprismatic
Surface Finish	W: Snow White, V: Ivory White, S: Radiant Silver, U: Urban Graphite, B: Jet Black, H: Anodic Champagne, K: Satin Copper, A: Satin Silver
Control Gear	X: Separately Dimmable
Colour Rendering	8: CRI>80, 9: CRI>90, F: Full Spectrum
Colour Temperature	27: 2700K, 30: 3000K, 35: 3500K, 40: 4000K, 65: 6500K
Power	M: Medium Power
Size	Square Size in mm: Q600
Base	C: Square with Soft Corners
Reflector	W: Snow White, V: Ivory White, S: Radiant Silver, U: Urban Graphite, B: Jet Black, H: Anodic Champagne, K: Satin Copper, G: Satin Gold
Plug	A: Schuko CEE 7/7 (Type E+F), B: CH T12 (Type J), C: UK BS 1363 (Type G), D: Wieland, E: WAGO



Microprismatic | Direct-Indirect

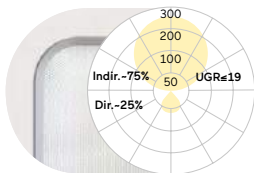

Q	Lumen/Watt
mm	Medium Power
600	16800lm/115W

Lumen Values: Luminarie luminous flux at 4000K/CRI>80. Other configurations on request.

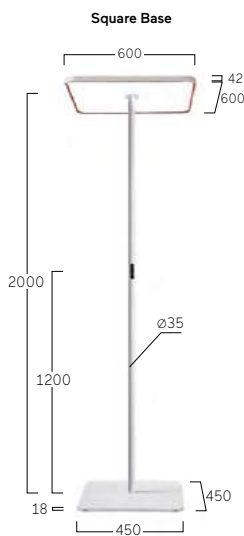

Separately Dimmable



W Snow White
W Snow White



W Snow White
S Radiant Silver



W Snow White
U Urban Graphite



W Snow White
B Jet Black



W Snow White
H Anodic Champagne



W Snow White
K Satin Copper

Cubic Evolution Floor

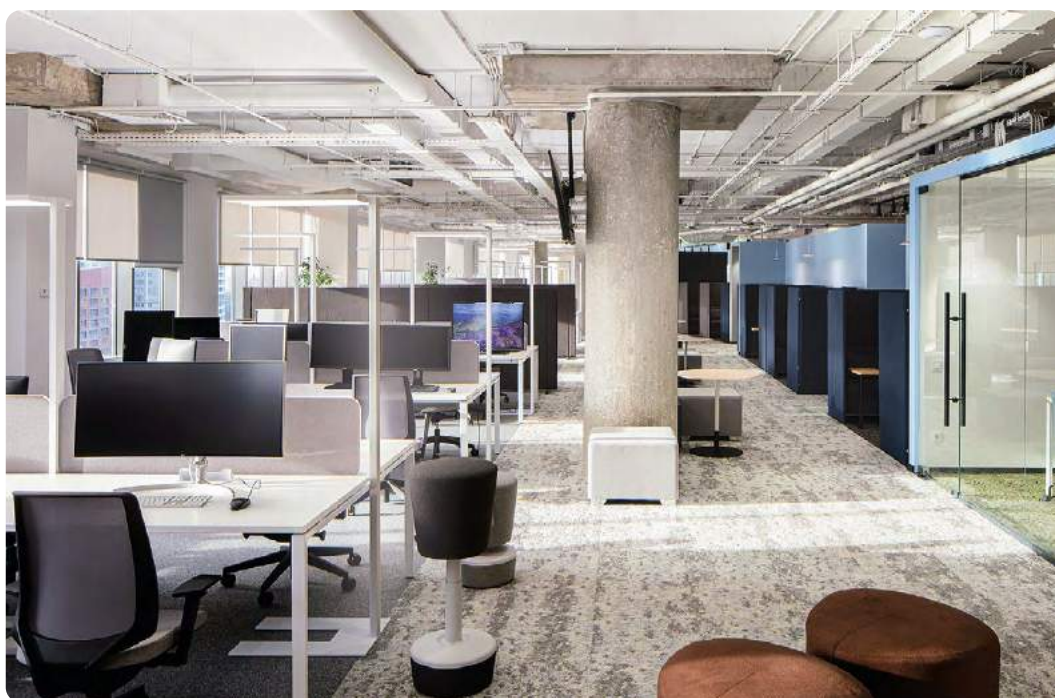

Aircraft Designer Office
(project released in 2021)
Cubic F2

Regional Association of Westphalia-Lippe (LWL)Münster, Germany
Cubic F3

Realization and photography: Scharkon Lichtkonzepte GmbH

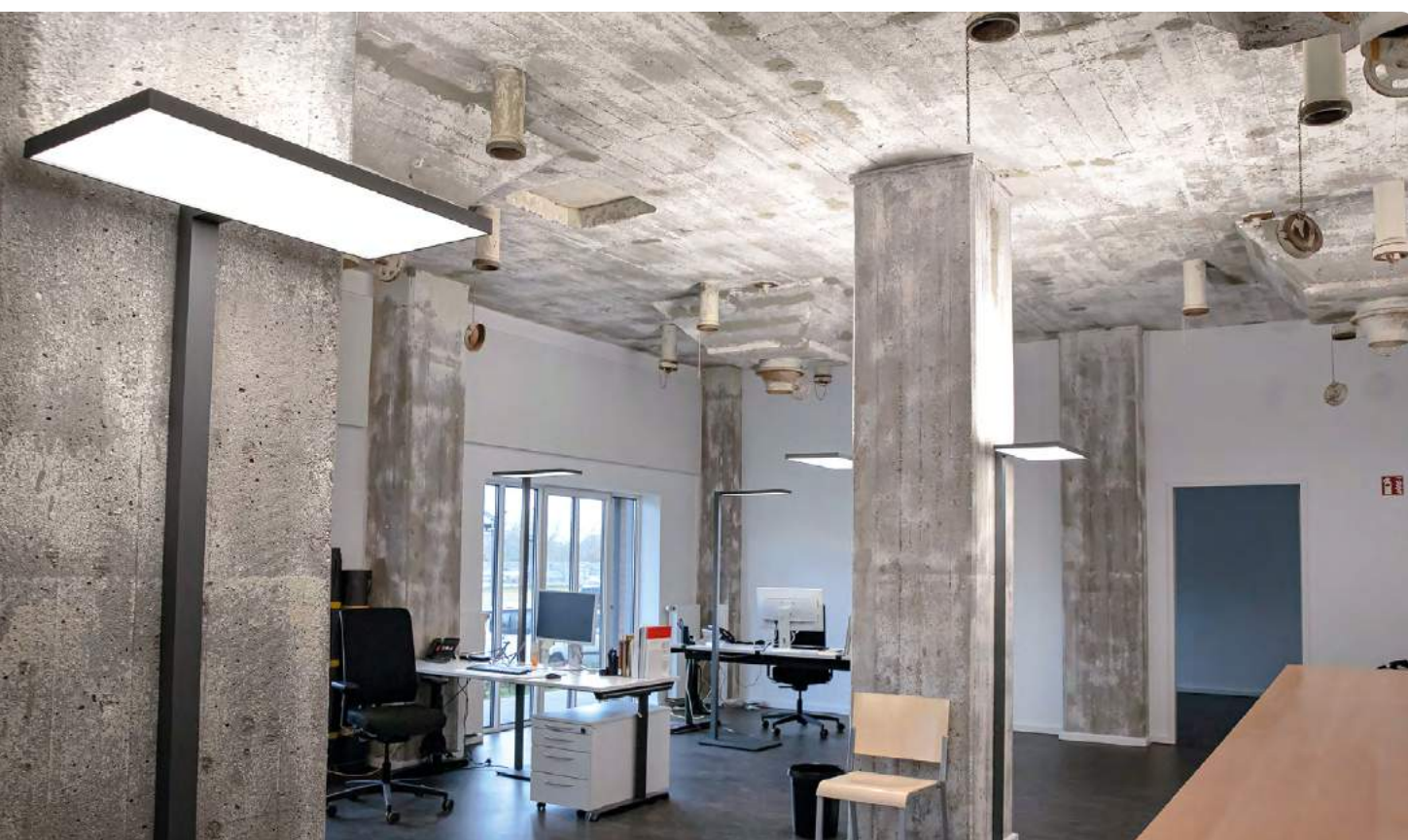



Rutheneum, Gera, Germany
Cubic F2

Cubic Evolution Floor





Sky Park by Zaha Hadid, Bratislava, Slovakia
Cubic F5
Planning: www.thelight.sk
Photography: www.kuivaniphotography.com



Cubic Evolution F1 | Floor



DE LED-Stehleuchte. Direkt-indirektstrahlend. Leuchtenkörper in minimalistischer Bauhöhe aus Aluminiumprofil. Oberfläche naturel oxidiert oder weiß, graphit, schwarz bzw. champagnerfarben lackiert. Weitere Oberflächenoptionen siehe Lightnet-Surface-Collection oder RAL nach Wahl. Microprismenoptik mit optimierter Blendungsbegrenzung speziell für Office-Anwendungen bei vollständiger Lichtpunktauflösung. Intuitives Bedienfeld im Leuchtenmast für getrennt stufenlose Dimmung und Schaltung der Kammern für Direkt-/Indirektlicht, bei Tunable White oder Integration von Multisensor- oder Schwarmtechnologie gemeinsame Steuerung der Lichtkammern. Optional: HCL-Control für automatisches, dem Tagesverlauf angepasstes, biodynamisches Licht. Farbtemperatur 2700K, 3000K, 3500K, 4000K, 6500K oder Tunable White (2700-6500K). Binning initial \leq MacAdam 3. Farbwiedergabe CRI $>$ 80, CRI $>$ 90 oder Full Spectrum. Rechteckige Fußplatte aus Stahl, optional mit U- oder Side-Cut-Out für unterschiedliche Tischausführungen, Lackierung passend Leuchtenkörper. 4m Anschlusskabel mit länderspezifischem Stecker (EU, CH, UK).

EN LED free-standing luminaire. Direct-indirect light distribution. Luminaire body with minimalistic overall height made of aluminium profile. Surface natural anodised or white, graphite, black or champagne coated. Further surface options see Lightnet-Surface-Collection or RAL of your choice. Microprismatic screen with optimized glare reduction especially for workplaces with uniform and enhanced light transmission. Intuitive pole mounted control panel for dimming and switching the direct/indirect light separately, joint control of the light chambers with Tunable White or integration of multi-sensor or swarm technology. Optional: HCL Control for automatic, time dependent, biodynamic lighting. Colour temperature 2700K, 3000K, 3500K, 4000K, 6500K or Tunable White (2700-6500K). Binning \leq MacAdam 3. Colour rendering CRI $>$ 80, CRI $>$ 90 or Full Spectrum. Rectangular steel base plate, option with U- or Side Cut-Out, colour matching luminaire body. 4m power cable with country-specific plug (EU, CH, UK).

CF1 A B X - 8 30 H - L900 - U - A

Product Family	C: Cubic
Type	F1: Direct-Indirect
Optical System	A: Microprismatic
Surface Finish	W: Snow White, E: Silver Anodised, U: Urban Graphite, B: Jet Black, H: Anodic Champagne
Control Gear	X: Separately Dimmable, M: Multisensor, R: Swarm Control, B: HCL
Colour Rendering	8: CRI>80, 9: CRI>90, F: Full Spectrum
Colour Temperature	27: 2700K, 30: 3000K, 35: 3500K, 40: 4000K, 65: 6500K, TW: Tunable White 2700-6500K
Power	M: Medium Power, H: High Power
Size	Head Length in mm: L900
Base	S: Side Cut-Out, U: U-Cut-Out, P: Rectangular
Plug	A: Schuko CEE 7/7 (Type E+F), B: CH T12 (Type J), C: UK BS 1363 (Type G), D: Wieland, E: WAGO



Microprismatic | Direct-Indirect

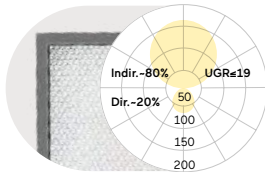

L mm	Lumen/Watt Medium Power	Lumen/Watt High Power
900	13900lm/95W	16000lm/114W

Lumen Values: Luminarie luminous flux at 4000K/CRI>80. Other configurations on request.



Multisensor / HCL / Swarm Control



Separately Dimmable



W Snow White

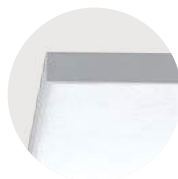

E Silver Anodised



U Urban Graphite



B Jet Black



H Anodic Champagne

Cubic Evolution F2 | Floor



DE LED-Stehleuchte. Direkt-indirektstrahlend. Leuchtenkörper in minimalistischer Bauhöhe aus Aluminiumprofil. Oberfläche naturel oxidiert oder weiß, graphit, schwarz bzw. champagnerfarben lackiert. Weitere Oberflächenoptionen siehe Lightnet-Surface-Collection oder RAL nach Wahl. Microprismenoptik mit optimierter Blendungsbegrenzung speziell für Office-Anwendungen bei vollständiger Lichtpunktauflösung. Intuitives Bedienfeld im Leuchtenmast für getrennt stufenlose Dimmung und Schaltung der Kammern für Direkt-/Indirektlicht, bei Tunable White oder Integration von Multisensor- oder Schwarmtechnologie gemeinsame Steuerung der Lichtkammern. Optional: HCL-Control für automatisches, dem Tagesverlauf angepasstes, biodynamisches Licht. Farbtemperatur 2700K, 3000K, 3500K, 4000K, 6500K oder Tunable White (2700-6500K). Binning initial \leq MacAdam 3. Farbwiedergabe CRI $>$ 80, CRI $>$ 90 oder Full Spectrum. Rechteckige Fußplatte aus Stahl, optional mit U- oder Side-Cut-Out für unterschiedliche Tischausführungen, Lackierung passend Leuchtenkörper. 4m Anschlusskabel mit länderspezifischem Stecker (EU, CH, UK).

EN LED free-standing luminaire. Direct-indirect light distribution. Luminaire body with minimalistic overall height made of aluminium profile. Surface natural anodised or white, graphite, black or champagne coated. Further surface options see Lightnet-Surface-Collection or RAL of your choice. Microprismatic screen with optimized glare reduction especially for workplaces with uniform and enhanced light transmission. Intuitive pole mounted control panel for dimming and switching the direct/indirect light separately, joint control of the light chambers with Tunable White or integration of multi-sensor or swarm technology. Optional: HCL Control for automatic, time dependent, biodynamic lighting. Colour temperature 2700K, 3000K, 3500K, 4000K, 6500K or Tunable White (2700-6500K). Binning \leq MacAdam 3. Colour rendering CRI $>$ 80, CRI $>$ 90 or Full Spectrum. Rectangular steel base plate, option with U- or Side Cut-Out for different table designs, colour matching luminaire body. 4m power cable with country-specific plug (EU, CH, UK).

C F2 A B X - 8 30 M - L600 - U - A

Product Family	C: Cubic
Type	F2: Direct-Indirect
Optical System	A: Microprismatic
Surface Finish	W: Snow White, E: Silver Anodised, U: Urban Graphite, B: Jet Black, H: Anodic Champagne
Control Gear	X: Separately Dimmable, M: Multisensor, R: Swarm Control, B: HCL
Colour Rendering	8: CRI>80, 9: CRI>90, F: Full Spectrum
Colour Temperature	27: 2700K, 30: 3000K, 35: 3500K, 40: 4000K, 65: 6500K, TW: Tunable White 2700-6500K
Power	M: Medium Power, H: High Power
Size	Head Length in mm: L600
Base	S: Side Cut-Out, U: U-Cut-Out, P: Rectangular
Plug	A: Schuko CEE 7/7 (Type E+F), B: CH T12 (Type J), C: UK BS 1363 (Type G), D: Wieland, E: WAGO



Microprismatic | Direct-Indirect

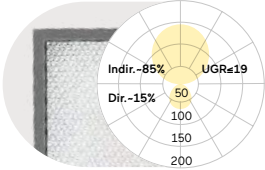

L mm	Lumen/Watt Medium Power	Lumen/Watt High Power
600	11100lm/68W	15300lm/92W

Lumen Values: Luminarie luminous flux at 4000K/CRI>80. Other configurations on request.



Cubic Evolution F3 | Floor



DE LED-Stehleuchte. Direkt-indirektstrahlend. Leuchtenkörper in minimalistischer Bauhöhe aus Aluminiumprofil. Oberfläche natureloxiert oder weiß, graphit, schwarz bzw. champagnerfarben lackiert. Weitere Oberflächenoptionen siehe Lightnet-Surface-Collection oder RAL nach Wahl. Microprismenoptik mit optimierter Blendungsbegrenzung speziell für Office-Anwendungen bei vollständiger Lichtpunktauflösung. Intuitives Bedienfeld im Leuchtenmast für getrennt stufenlose Dimmung und Schaltung der Kammern für Direkt-/Indirektlicht, bei Tunable White oder Integration von Multisensor- oder Schwarmtechnologie gemeinsame Steuerung der Lichtkammern. Optional: HCL-Control für automatisches, dem Tagesverlauf angepasstes, biodynamisches Licht. Farbtemperatur 2700K, 3000K, 3500K, 4000K, 6500K oder Tunable White (2700-6500K). Binning initial \leq MacAdam 3. Farbwiedergabe CRI $>$ 80, CRI $>$ 90 oder Full Spectrum. Rechteckige Fußplatte aus Stahl, optional mit U- oder Side-Cut-Out für unterschiedliche Tischausführungen, Lackierung passend Leuchtenkörper. 4m Anschlusskabel mit länderspezifischem Stecker (EU, CH, UK).

EN LED free-standing luminaire. Direct-indirect light distribution. Luminaire body with minimalistic overall height made of aluminium profile. Surface natural anodised or white, graphite, black or champagne coated. Further surface options see Lightnet-Surface-Collection or RAL of your choice. Microprismatic screen with optimized glare reduction especially for workplaces with uniform and enhanced light transmission. Intuitive pole mounted control panel for dimming and switching the direct/indirect light separately, joint control of the light chambers with Tunable White or integration of multi-sensor or swarm technology. Optional: HCL Control for automatic, time dependent, biodynamic lighting. Colour temperature 2700K, 3000K, 3500K, 4000K, 6500K or Tunable White (2700-6500K). Binning \leq MacAdam 3. Colour rendering CRI $>$ 80, CRI $>$ 90 or Full Spectrum. Rectangular steel base plate, options with U- or Side Cut-Out for different table designs, colour matching luminaire body. 4m power cable with country-specific plug (EU, CH, UK).

CF3ABX-830M-L600-U-A

Product Family	C: Cubic
Type	F3: Direct-Indirect
Optical System	A: Microprismatic
Surface Finish	W: Snow White, E: Silver Anodised, U: Urban Graphite, B: Jet Black, H: Anodic Champagne
Control Gear	X: Separately Dimmable, M: Multisensor, R: Swarm Control, B: HCL
Colour Rendering	8: CRI>80, 9: CRI>90, F: Full Spectrum
Colour Temperature	27: 2700K, 30: 3000K, 35: 3500K, 40: 4000K, 65: 6500K, TW: Tunable White 2700-6500K
Power	M: Medium Power, H: High Power
Size	Head Length in mm: L600
Base	S: Side Cut-Out, U: U-Cut-Out, P: Rectangular
Plug	A: Schuko CEE 7/7 (Type E+F), B: CH T12 (Type J), C: UK BS 1363 (Type G), D: Wieland, E: WAGO



Microprismatic | Direct-Indirect

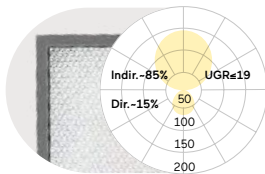

L mm	Lumen/Watt Medium Power	Lumen/Watt High Power
---------	----------------------------	--------------------------

600 11100lm/75W 15300lm/104W

Lumen Values: Luminarie luminous flux at 4000K/CRI>80. Other configurations on request.

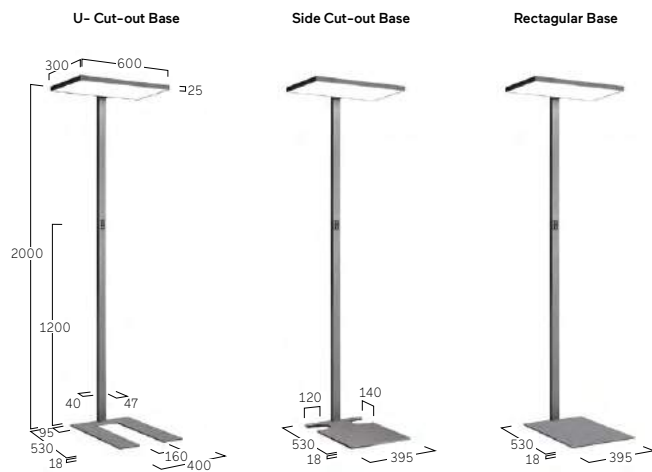

Multisensor/HCL /Swarm Control



Separately Dimmable



W Snow White

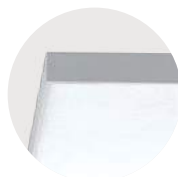

E Silver Anodised



U Urban Graphite



B Jet Black



H Anodic Champagne

Cubic Evolution F5/F6 | Floor



DE LED-Stehleuchte. Direkt-indirektstrahlend. Leuchtenkörper in minimalistischer Bauhöhe aus Aluminiumprofil. Oberfläche natureloxiert oder weiß, graphit, schwarz bzw. champagnerfarben lackiert. Weitere Oberflächenoptionen siehe Lightnet-Surface-Collection oder RAL nach Wahl. Microprismenoptik mit optimierter Blendungsbegrenzung speziell für Office-Anwendungen bei vollständiger Lichtpunktauflösung. Intuitive Bedienfelder im Leuchtenmast für getrennt stufenlose Dimmung und Schaltung der Kammern für Direkt-/Indirektlicht je Leuchtenkopf, bei Tunable White oder Integration von Multisensor- oder Schwarmtechnologie gemeinsame Steuerung der Lichtkammern je Leuchtenkopf. Farbtemperatur 2700K, 3000K, 3500K, 4000K, 6500K oder Tunable White (2700-6500K). Binning initial \leq MacAdam 3. Farbwiedergabe $\text{CRI} > 80$, $\text{CRI} > 90$ oder Full Spectrum. Rechteckige Fußplatte aus Stahl, Lackierung passend Leuchtenkörper. 4m Anschlusskabel mit länderspezifischem Stecker (EU, CH, UK).

EN LED free-standing luminaire. Direct-indirect light distribution. Luminaire body with minimalistic overall height made of aluminium profile. Surface natural anodised or white, graphite, black or champagne coated. Further surface options see Lightnet-Surface-Collection or RAL of your choice. Microprismatic screen with optimized glare reduction especially for workplaces with uniform and enhanced light transmission. Intuitive pole mounted control panels for dimming and switching the direct/indirect light separately per luminaire head, joint control of the light chambers per luminaire head with Tunable White or integration of multi-sensor or swarm technology. Colour temperature 2700K, 3000K, 3500K, 4000K, 6500K or Tunable White (2700-6500K). Binning \leq MacAdam 3. Colour rendering $\text{CRI} > 80$, $\text{CRI} > 90$ or Full Spectrum. Rectangular steel base plate, colour matching luminaire body. 4m power cable with country-specific plug (EU, CH, UK).

CF5A B X - 830 M - L600 - P-A

Product Family	C: Cubic
Type	F5: Direct-Indirect - Symmetrical Stand, F6: Direct-Indirect - Asymmetrical Stand
Optical System	A: Microprismatic
Surface Finish	W: Snow White, E: Silver Anodised, U: Urban Graphite, B: Jet Black, H: Anodic Champagne
Control Gear	X: Separately Dimmable, M: Multisensor, R: Swarm Control
Colour Rendering	8: CRI>80, 9: CRI>90, F: Full Spectrum
Colour Temperature	27: 2700K, 30: 3000K, 35: 3500K, 40: 4000K, 65: 6500K, TW: Tunable White 2700-6500K
Power	M: Medium Power, H: High Power
Size	Head Length in mm: L600
Base	P: Rectangular (F5 only), S: Side Cut-Out (F6 only), U: U-Cut-Out (F6 only)
Plug	A: Schuko CEE 7/7 (Type E+F), B: CH T12 (Type J), C: UK BS 1363 (Type G), D: Wieland, E: WAGO



Microprismatic | Direct-Indirect

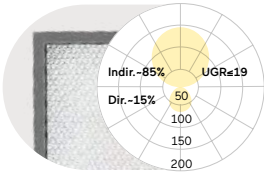

L mm	Lumen/Watt Medium Power	Lumen/Watt High Power
600	11500lm/88W	15500lm/114W

Lumen Values: Luminaire luminous flux at 4000K/CRI>80. Other configurations on request.

F5 Symmetrical Stand, Rectangular Base

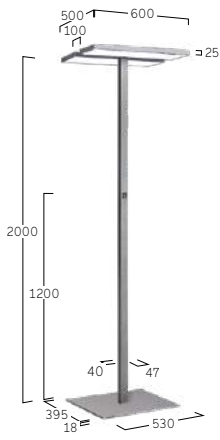

F6 Asymmetrical Stand, U- Cut-out

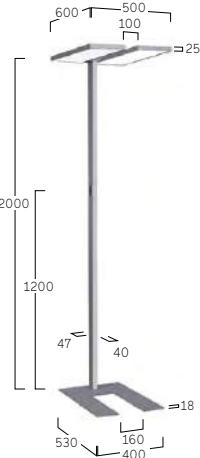

F6 Asymmetrical Stand, Side Cut-out



Multisensor /Swarm Control



Separately Dimmable



W Snow White



E Silver Anodised

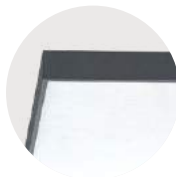

U Urban Graphite



B Jet Black



H Anodic Champagne

Cubic Evolution F7 | Floor



DE LED-Stehleuchte. Direkt-indirektstrahlend. Leuchtenkörper in minimalistischer Bauhöhe aus Aluminiumprofil. Oberfläche naturel oxidiert oder weiß, graphit, schwarz bzw. champagnerfarben lackiert. Weitere Oberflächenoptionen siehe Lightnet-Surface-Collection oder RAL nach Wahl. Microprismenoptik mit optimierter Blendungsbegrenzung speziell für Office-Anwendungen bei vollständiger Lichtpunktauflösung. Intuitive Bedienfelder im Leuchtenmast für getrennt stufenlose Dimmung und Schaltung der Kammern für Direkt-/Indirektlicht je Leuchtenkopf, bei Tunable White oder Integration von Multisensor- oder Schwarmtechnologie gemeinsame Steuerung der Lichtkammern je Leuchtenkopf. Farbtemperatur 2700K, 3000K, 3500K, 4000K, 6500K oder Tunable White (2700-6500K). Binning initial \leq MacAdam 3. Farbwiedergabe CRI $>$ 80, CRI $>$ 90 oder Full Spectrum. H-Fußplatte aus Stahl, Lackierung passend Leuchtenkörper. 4m Anschlusskabel mit länderspezifischem Stecker (EU, CH, UK).

EN LED free-standing luminaire. Direct-indirect light distribution. Luminaire body with minimalistic overall height made of aluminium profile. Surface natural anodised or white, graphite, black or champagne coated. Further surface options see Lightnet-Surface-Collection or RAL of your choice. Microprismatic screen with optimized glare reduction especially for workplaces with uniform and enhanced light transmission. Intuitive pole mounted control panels for dimming and switching the direct/indirect light separately per luminaire head, joint control of the light chambers per luminaire head with Tunable White or integration of multi-sensor or swarm technology. Colour temperature 2700K, 3000K, 3500K, 4000K, 6500K or Tunable White (2700-6500K). Binning \leq MacAdam 3. Colour rendering CRI $>$ 80, CRI $>$ 90 or Full Spectrum. H-Base plate made of steel, colour matching luminaire body. 4m power cable with country-specific plug (EU, CH, UK).

C F7 A B X - 8 30 M - L1320 - H - A

Product Family	C: Cubic
Type	F7: Direct-Indirect
Optical System	A: Microprismatic
Surface Finish	W: Snow White, E: Silver Anodised, U: Urban Graphite, B: Jet Black, H: Anodic Champagne
Control Gear	X: Separately Dimmable, M: Multisensor, R: Swarm Control
Colour Rendering	8: CRI>80, 9: CRI>90, F: Full Spectrum
Colour Temperature	27: 2700K, 30: 3000K, 35: 3500K, 40: 4000K, 65: 6500K, TW: Tunable White 2700-6500K
Power	M: Medium Power, H: High Power
Size	Head Length in mm: L1320
Base	H: H-Cut-Out
Plug	A: Schuko CEE 7/7 (Type E+F), B: CH T12 (Type J), C: UK BS 1363 (Type G), D: Wieland, E: WAGO



Microprismatic | Direct-Indirect

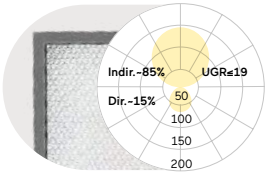

L	Lumen/Watt	Lumen/Watt
mm	Medium Power	High Power

1320 22200lm/136W 30600lm/184W

Lumen Values: Luminarie luminous flux at 4000K/CRI>80. Other configurations on request.

H- Cut-out Base

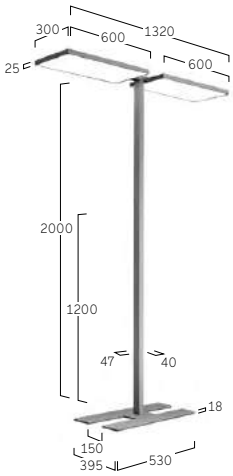

Multisensor /Swarm Control



Separately Dimmable



W Snow White



E Silver Anodised



U Urban Graphite

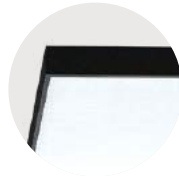

B Jet Black



H Anodic Champagne

Cubic Evolution F8 | Floor



DE LED-Stehleuchte. Direkt-indirektstrahlend. Leuchtenkörper in minimalistischer Bauhöhe aus Aluminiumprofil. Oberfläche natureloxiiert oder weiß, graphit, schwarz bzw. champagnerfarben lackiert. Weitere Oberflächenoptionen siehe Lightnet-Surface-Collection oder RAL nach Wahl. Microprismenoptik mit optimierter Blendungsbegrenzung speziell für Office-Anwendungen bei vollständiger Lichtpunktauflösung. Indirektanteil mit innovativer Linsentechnologie für breitstrahlende Deckenaufhellung. Intuitives Bedienfeld im Leuchtenmast für getrennt stufenlose Dimmung und Schaltung der Kammern für Direkt-/Indirektlicht. Farbtemperatur 2700K, 3000K, 3500K, 4000K oder 6500K. Binning initial \leq MacAdam 3. Farbwiedergabe CRI>80, CRI>90 oder Full Spectrum. Rechteckige Fußplatte aus Stahl mit U-Cut-Out, Lackierung passend Leuchtenkörper. 4m Anschlusskabel mit länderspezifischem Stecker (EU, CH, UK).

EN LED free-standing luminaire. Direct-indirect light distribution. Luminaire body with minimalistic overall height made of aluminium profile. Surface natural anodised or white, graphite, black or champagne coated. Further surface options see Lightnet-Surface-Collection or RAL of your choice. Microprismatic screen with optimized glare reduction especially for workplaces with uniform and enhanced light transmission. Indirect light with innovative lens technology for wide-angle ceiling illumination. Intuitive pole mounted control panel for dimming and switching the direct/indirect light separately. Colour temperature 2700K, 3000K, 3500K, 4000K or 6500K. Binning \leq MacAdam 3. Colour rendering CRI>80, CRI>90 or Full Spectrum. Rectangular steel base plate with U-Cut-Out, colour matching luminaire body. 4m power cable with country-specific plug (EU, CH, UK).

CF8 A B X - 8 30 M - L800-U-A

Product Family	C: Cubic
Type	F8: Direct-Indirect
Optical System	A: Microprismatic
Surface Finish	W: Snow White, E: Silver Anodised, U: Urban Graphite, B: Jet Black, H: Anodic Champagne
Control Gear	X: Separately Dimmable
Colour Rendering	8: CRI>80, 9: CRI>90, F: Full Spectrum
Colour Temperature	27: 2700K, 30: 3000K, 35: 3500K, 40: 4000K, 65: 6500K
Power	M: Medium Power, H: High Power
Size	Head Length in mm: L800
Base	U: U-Cut-Out
Plug	A: Schuko CEE 7/7 (Type E+F), B: CH T12 (Type J), C: UK BS 1363 (Type G), D: Wieland, E: WAGO



Microprismatic | Direct-Indirect

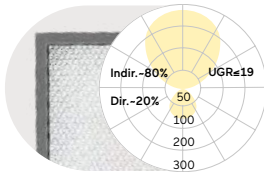

L mm	Lumen/Watt Medium Power	Lumen/Watt High Power
800	18100lm/119W	23900lm/155W

Lumen Values: Luminarie luminous flux at 4000K/CRI>80. Other configurations on request.

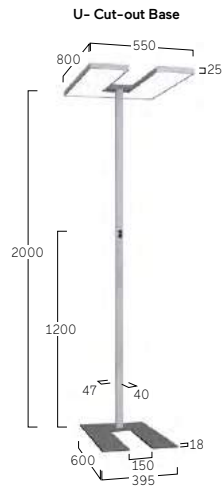

Separately Dimmable



W Snow White



E Silver Anodised



U Urban Graphite



B Jet Black



H Anodic Champagne

Matric SX | System 40 mm Floor One Head



DE LED-Stehleuchte. Direkt- indirektstrahlend. Leuchtenkörper aus Aluminiumprofil. Oberfläche weiß, silber, graphit, schwarz, champagner oder kupferfarben lackiert. Weitere Oberflächenoptionen siehe Lightnet-Surface-Collection oder RAL nach Wahl. Direktanteil über Präzisionslinsen mit Abblendraster für breite rotationssymmetrische Lichtstärkeverteilung bei gleichzeitig hoher Blendungsbegrenzung ($UGR < 19$). Abblendraster in verschiedenen Farbkombinationen erhältlich. Microprismenoptik mit optimierter Blendungsbegrenzung ($UGR < 19$) speziell für Office-Anwendungen bei vollständiger Lichtpunktauflösung. Intuitives Bedienfeld im Leuchtenmast für getrennt stufenlose Dimmung und Schaltung der Kammern für Direkt-/Indirektlicht, bei Tunable White oder Integration von Multisensor- oder Schwarmtechnologie gemeinsame Steuerung der Lichtkammern. Optional: HCL-Control für automatisches, dem Tagesverlauf angepasstes, biodynamisches Licht. Farbtemperatur 2700K, 3000K, 3500K, 4000K, 6500K oder Tunable White (2700-6500K). Binning initial \leq MacAdam 3. Farbwiedergabe $CRI > 80$, $CRI > 90$ oder Full Spectrum. Rechteckige Fußplatte aus Stahl mit U- oder Side-Cut-Out für unterschiedliche Tischausführungen, Lackierung passend Leuchtenkörper. 4m Anschlusskabel mit länderspezifischem Stecker (EU, CH, UK).

EN LED free-standing luminaire. Direct-indirect light distribution. Luminaire body made of aluminum profile. Surface white, silver, graphite, black, champagne or copper coated. Further surface options see Lightnet-Surface-Collection or RAL of your choice. Direct light using precision lenses with louvre for wide uniform symmetrical light distribution with high glare limitation ($UGR < 19$). Louvre available in various colour finishes. Microprismatic screen with optimized glare reduction ($UGR < 19$) especially for workplaces with uniform and enhanced light transmission. Intuitive pole mounted control panel for dimming and switching the direct/indirect light separately, joint control of the light chambers with Tunable White or integration of multi-sensor or swarm technology. Optional: HCL-Control for automatic biodynamic light adapted to the course of the day. Colour temperature 2700K, 3000K, 3500K, 4000K, 6500K or Tunable White (2700-6500K). Binning \leq MacAdam 3. Colour rendering $CRI > 80$, $CRI > 90$ or Full Spectrum. Rectangular steel base plate with U- or Side Cut-Out for different table designs, colour matching luminaire body. 4m power cable with country-specific plug (EU, CH, UK).

L S X L S M - 8 3 0 M - L 1 5 7 0 - U B * - A

Product Family	L: Matric
Type	SX: Direct-Indirect
Optical System	L: Lens Louvre*, A: Microprismatic
Surface Finish	W: Snow White, V: Ivory White, A: Satin Silver, S: Radiant Silver, U: Urban Graphite, B: Jet Black, H: Anodic Champagne, K: Satin Copper
Control Gear	X: Separately Dimmable, M: Multisensor, R: Swarm Control, B: HCL
Colour Rendering	8: CRI>80, 9: CRI>90, F: Full Spectrum
Colour Temperature	27: 2700K, 30: 3000K, 35: 3500K, 40: 4000K, 65: 6500K, TW: Tunable White 2700-6500K
Power	M: Medium Power
Size	Head Length in mm: L1470 (Separately Dimmable), L1570 (Multisensor, Swarm Control, HCL)
Base	S: Side Cut-Out, U: U-Cut-Out
Reflector*	W: Snow White, B: Jet Black, A: Satin Silver, H: Anodic Champagne, K: Satin Copper, G: Satin Gold
Plug	A: Schuko CEE 7/7 (Type E+F), B: CH T12 (Type J), C: UK BS 1363 (Type G), D: Wieland, E: WAGO



Lens Louvre | Direct-Indirect

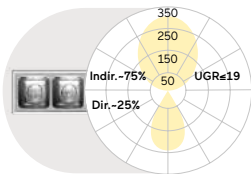

Microprismatic | Direct-Indirect

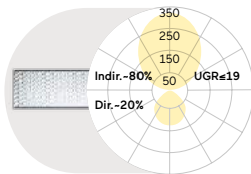

Power	Lumen/Watt	Power	Lumen/Watt
Medium Power	10300lm/85W	Medium Power	10000lm/96W

Lumen Values: Luminaire luminous flux at 4000K/CRI>80. Other configurations on request.

U- Cut-out Base

Side Cut-Out Base

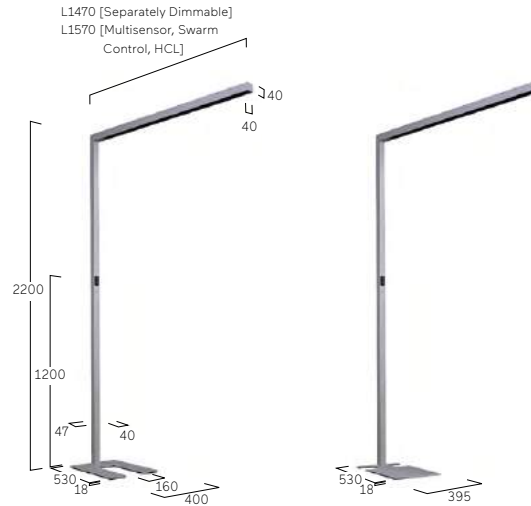

Multisensor / Swarm Control



Separately Dimmable



V Ivory White
W Snow White



V Ivory White
A Satin Silver



V Ivory White
B Jet Black



V Ivory White
H Anodic Champagne



V Ivory White
K Satin Copper



V Ivory White
G Satin Gold



A Satin Silver
B Jet Black



A Satin Silver
A Satin Silver



B Jet Black
B Jet Black



B Jet Black
H Anodic Champagne



B Jet Black
G Satin Gold



H Anodic Champagne
B Jet Black

Matric SY | System 40 mm Floor Two Heads



DE LED-Stehleuchte. Direkt- indirektstrahlend. Leuchtenkörper aus Aluminiumprofil. Oberfläche weiß, silber, graphit, schwarz, champagner oder kupferfarben lackiert. Weitere Oberflächenoptionen siehe Lightnet-Surface-Collection oder RAL nach Wahl. Direktanteil über Präzisionslinsen mit Abblendraster für breite rotationssymmetrische Lichtstärkeverteilung bei gleichzeitig hoher Blendungsbegrenzung ($UGR < 19$). Abblendraster in verschiedenen Farbkombinationen erhältlich. Microprismenoptik mit optimierter Blendungsbegrenzung ($UGR < 19$) speziell für Office-Anwendungen bei vollständiger Lichtpunktauflösung. Intuitive Bedienfelder im Leuchtenmast für getrennt stufenlose Dimmung und Schaltung der Kammern für Direkt-/Indirektlicht je Leuchtenkopf, bei Tunable White oder Integration von Multi-sensor- oder Schwarmtechnologie gemeinsame Steuerung der Lichtkammern je Leuchtenkopf. Farbtemperatur 2700K, 3000K, 3500K, 4000K, 6500K oder Tunable White (2700-6500K). Binning initial \leq MacAdam 3. Farbwiedergabe $CRI > 80$, $CRI > 90$ oder Full Spectrum. Rechteckige Fußplatte aus Stahl mit H-Cut-Out, Lackierung passend Leuchtenkörper. 4m Anschlusskabel mit länderspezifischem Stecker (EU, CH, UK).

EN LED free-standing luminaire. Direct-indirect light distribution. Luminaire body made of aluminum profile. Surface white, silver, graphite, black, champagne or copper coated. Further surface options see Lightnet-Surface-Collection or RAL of your choice. Direct light using precision lenses with louvre for wide uniform symmetrical light distribution with high glare limitation ($UGR < 19$). Louvre available in various colour finishes. Microprismatic screen with optimized glare reduction ($UGR < 19$) especially for workplaces with uniform and enhanced light transmission. Intuitive pole mounted control panels for dimming and switching the direct/indirect light separately per luminaire head, joint control of the light chambers per luminaire head with Tunable White or integration of multi-sensor or swarm technology. Colour temperature 2700K, 3000K, 3500K, 4000K, 6500K or Tunable White (2700-6500K). Binning \leq MacAdam 3. Colour rendering $CRI > 80$, $CRI > 90$ or Full Spectrum. Rectangular steel base plate with H-Cut-Out, colour matching luminaire body. 4m power cable with country-specific plug (EU, CH, UK).

L SYLSM-830 M-L3100-HB*-A

Product Family	L: Matric
Type	SY: Direct-Indirect
Optical System	L: Lens Louvre*, A: Microprismatic
Surface Finish	W: Snow White, V: Ivory White, A: Satin Silver, S: Radiant Silver, U: Urban Graphite, B: Jet Black, H: Anodic Champagne, K: Satin Copper
Control Gear	X: Separately Dimmable, M: Multisensor, R: Swarm Control
Colour Rendering	8: CRI>80, 9: CRI>90, F: Full Spectrum
Colour Temperature	27: 2700K, 30: 3000K, 35: 3500K, 40: 4000K, 65: 6500K, TW: Tunable White 2700-6500K
Power	M: Medium Power
Size	Head Length in mm: L2900 (Separately Dimmable), L3100 (Multisensor, Swarm Control)
Base	H: H-Cut-Out
Reflector*	W: Snow White, B: Jet Black, A: Satin Silver, H: Anodic Champagne, K: Satin Copper, G: Satin Gold
Plug	A: Schuko CEE 7/7 (Type E+F), B: CH T12 (Type J), C: UK BS 1363 (Type G), D: Wieland, E: WAGO



Lens Louvre | Direct-Indirect

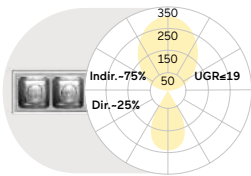

Microprismatic | Direct-Indirect

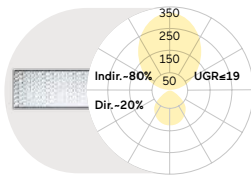

Power	Lumen/Watt	Power	Lumen/Watt
Medium Power	20600lm/170W	Medium Power	20000lm/192W

Lumen Values: Luminaire luminous flux at 4000K/CRI>80. Other configurations on request.

H- Cut-out Base

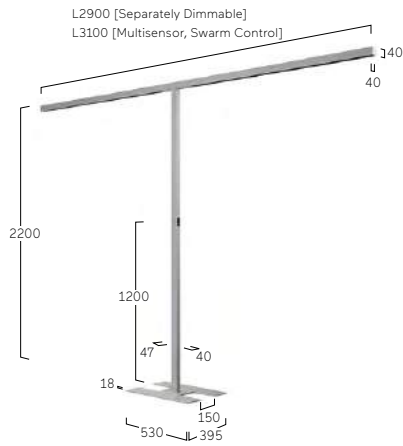

Multisensor / Swarm Control



Separately Dimmable



V Ivory White
W Snow White



V Ivory White
A Satin Silver



V Ivory White
B Jet Black



V Ivory White
H Anodic Champagne



V Ivory White
K Satin Copper



V Ivory White
G Satin Gold



A Satin Silver
B Jet Black



A Satin Silver
A Satin Silver



B Jet Black
B Jet Black



B Jet Black
H Anodic Champagne



B Jet Black
G Satin Gold



H Anodic Champagne
B Jet Black



Lucille W1 |
Wall
124



Midpin W2 |
Wall
126



Midpoint W7 |
Wall
128



Basic Superflat X7/Y7 |
Wall
130



Basic Neo W5 |
Wall
132



Basic Neo Y5/X5 |
Wall
134



Basic Déco Y3/X3 |
Wall
136



Basic Visio Y9/X9 |
Wall
138



Liquid Line Compact
W5 | Wall
140



Liquid Line WX |
System 40mm Wall
142



Caleo Neo Y6/X6 |
Wall
144



Cubic Evolution W4 |
Wall
148



Cubic Evolution Y6/X6 |
Wall
150



Cubic Déco A3 |
Wall
152



Cubic Ambient A7 |
Wall
154



Matric Ambient AX |
System 40mm Wall
158



Matric WX |
System 40mm Wall
160



Matric DX |
System 40mm Wall
162



Matric JX |
System 40mm Wall
164



Matric W4 |
System 55mm Wall
166



Matric W6 |
System 81mm Wall
168

Wand | Wall

Lucille W



Private Residence, Cologne, Germany
Lucille-W1





Private Residence, Bielsko-Biala, Poland
Lucille-W1

Lucille W1 | Wall



DE LED-Wandanbauleuchte. Microprismenoptik aus Acrylglas für optimierte Entblendung und Lichtlenkung. Minimalistischer Leuchtenkopf mit perfekt homogener und vollflächiger Auflösung der Lichtpunkte. Hochwertiger Pantograf mit Präzisionsgelenken komplett aus Aluminium. Keine sichtbaren Kabel, Federn oder Seile. Oberfläche wahlweise weiß, silber, schwarz oder champagnerfarben lackiert. Intuitive Bedienung über Touchfeld im Leuchtenkopf. Lichtlevel stufenlos dimmbar. Hohe Flexibilität durch seitlich schwenkbares Wandelement. Standard Farbtemperatur 2700K, 3000K oder 4000K. Binning initial \leq MacAdam 3. Farbwiedergabe CRI $>$ 80, CRI $>$ 90 oder Full Spectrum.

EN LED wall mounted luminaire. Microprismatic screen made of acrylic glass for optimised glare control and light direction. Minimalistic luminaire head with perfect uniform and enhanced light transmission. High-quality pantograph with precision joints completely made of aluminium. No visible cables, springs or cords. Surface available in white, silver, black or champagne coated. Intuitive control via touch control panel in the luminaire head. Light output level continuously dimmable. High flexibility due to laterally swivelling wall element. Standard colour temperature 2700K, 3000K or 4000K. Binning \leq MacAdam 3. Colour rendering CRI $>$ 80, CRI $>$ 90 or Full Spectrum.

UW1 A A S-8 30 M-D150-C

Product Family	U: Lucille
Type	W1: Direct only
Optical System	A: Microprismatic
Surface Finish	V: Ivory White, A: Satin Silver, B: Jet Black, H: Anodic Champagne
Control Gear	S: Switch & Dimm
Colour Rendering	8: CRI>80, 9: CRI>90, F: Full Spectrum [except 2200K]
Colour Temperature	22: 2200K, 27: 2700K, 30: 3000K, 35: 3500K, 40: 4000K, 65: 6500K
Power	M: Medium Power
Size	Head Diameter in mm: D150
Power Supply	C: With Cord, W: Through the Wall



Microprismatic | Direct

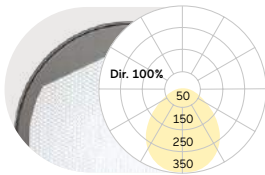

D mm	Lumen/Watt Medium Power
150	1000lm/13W

Lumen Values: Luminaire luminous flux at 4000K/CRI>80. Other configurations on request.

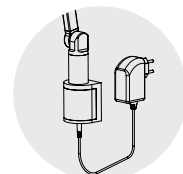

Power Supply with cord

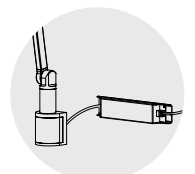

Power Supply through the wall



V Ivory White

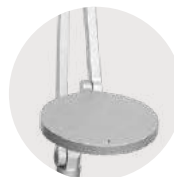

A Satin Silver



B Jet Black



H Anodic Champagne

Midpin W2 | Wall



DE LED-Strahler für Wandanbaumontage. Direkt-indirektstrahlend. Konverter in Leuchtgehäuse integriert, wahlweise einfach schaltbar oder stufenlos dimmbar (DALI). Gehäuse aus Aluminium in weiß, silber, schwarz oder champagnerfarben lackiert. Weitere Oberflächenoptionen siehe Lightnet Surface Collection oder RAL nach Wahl. Farbtemperatur wahlweise 2700K, 3000K oder 4000K oder als Dim to Warm 3000K-1800K. Farbwiedergabe CRI>90. Binning initial \leq MacAdam 3. Austauschbare Linsenoptik mit Ausstrahlwinkel 30° (Medium) oder 40° (Flood). Optikring in verschiedenen Farbausführungen erhältlich.

EN LED spotlight for wall surface mounting. Direct-indirect light distribution. Driver integrated into luminaire housing, optionally switchable or dimmable (DALI). Housing made of white, silver, black or champagne coated aluminum. Further surface options see Lightnet-Surface-Collection or RAL of your choice. Colour temperature available as 2700K, 3000K or 4000K or as Dim to Warm 3000K-1800K. Colour rendering CRI>90. Binning \leq MacAdam 3. Changeable lens optics with beam angle 30° (medium) or 40° (flood). Optic ring available in different colour versions.

DW2BBE-9 27 M-G

Product Family	D: Midpin
Type	W2: Direct-Indirect
Lens Angle	B: Medium 30°, C: Flood 40°
Surface Finish	W: Snow White, V: Ivory White, A: Satin Silver, B: Jet Black, H: Anodic Champagne
Control Gear	E: On/Off, L: DALI, H: Touch-Dim
Colour Rendering	9: CRI>90
Colour Temperature	27: 2700K, 30: 3000K, 35: 3500K, 40: 4000K, DW: Dim to Warm 1800K-3000K [DALI only]
Power	M: Medium Power
Optic Ring	W: Snow White, V: Ivory White, A: Satin Silver, B: Jet Black, H: Anodic Champagne, G: Satin Gold, K: Satin Copper



Medium 30° Led Engine Eco, Medium Power

Mounting Height	Illuminance[Lux] center/side	Beam Diameter
4 m	130/58	2.30 m
3 m	231/103	1.70 m
2 m	520/232	1.10 m
1 m	2079/929	0.57 m
1 m	2079/929	0.57 m
2 m	520/232	1.10 m
3 m	231/103	1.70 m
4 m	130/58	2.30 m

LED Engine	2700K	3000K	3500K	4000K
22W	1220 lm	1420 lm	1500 lm	1500 lm

Flood 40° Led Engine Eco, Medium Power

Mounting Height	Illuminance[Lux] center/side	Beam Diameter
4 m	91/37	3.10 m
3 m	162/66	2.30 m
2 m	364/148	1.50 m
1 m	1454/591	0.77 m
1 m	1454/591	0.77 m
2 m	364/148	1.50 m
3 m	162/66	2.30 m
4 m	91/37	3.10 m

LED Engine	2700K	3000K	3500K	4000K
22W	1240 lm	1460 lm	1540 lm	1540 lm

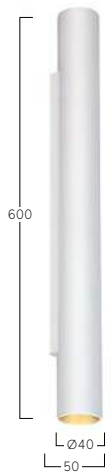

B Jet Black
W Snow White



B Jet Black
A Satin Silver



B Jet Black
B Jet Black

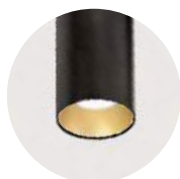

B Jet Black
G Satin Gold



B Jet Black
H Anodic Champagne



B Jet Black
K Satin Copper

Midpoint W7 | Wall



DE LED-Strahler für Wandanbaumontage. Direkt-indirektstrahlend. Konverter in Leuchtenkörper integriert, wahlweise einfach schaltbar oder stufenlos dimmbar (DALI). Gehäuse aus Aluminium in weiß, silber, schwarz oder champagnerfarben lackiert. Weitere Oberflächenoptionen siehe Lightnet Surface Collection oder RAL nach Wahl. LED Engine wahlweise XICATO ARTIST für höchste Lichtqualität mit bester Farbwiedergabe und 5 Jahre Garantie für Farbkonstanz (MacAdam \leq 3) oder ECO für höchste Energieeffizienz bei optimalem Preis-Leistungsverhältnis und CRI>90. Farbtemperaturen 2700K, 3000K oder 4000K. Austauschbare Linsen-Reflektoroptiken mit sphärischer Facettenoptik. Ausstrahlwinkel: 10° (Spot), 20° (Medium), 35° (Flood) oder 50° (Wide Flood). Reflektorring in verschiedenen Farbausführungen erhältlich. Standardmäßig klare Abdeckung. Optional zusätzliche Filter oder Wabenraster.

EN LED spotlight for wall surface mounting. Direct-indirect light distribution. Driver integrated into luminaire body, optionally switchable or dimmable (DALI). Housing made of white, silver, black or champagne coated aluminum. Further surface options see Lightnet-Surface-Collection or RAL of your choice. LED Engine with XICATO ARTIST for highest light quality and colour rendering, including 5-year warranty for colour consistency (MacAdams 3) or ECO for highest energy efficiency with optimal price performance ratio and CRI> 90. Colour temperature 2700K, 3000K or 4000K. Replaceable lens reflector optic with spherical faceted optic. Beam angle: 10° (Spot), 20° (Medium), 35° (Flood) or 50° (Wide Flood). Reflector ring available in different colour versions. Standard clear cover. Optional additional filters or honeycomb louvre.

PW7AWE-9 27 FM-GK

Product Family	P: Midpoint
Type	W7: Direct-Indirect
Beam Angle	A: Spot 10°, B: Medium 20°, C: Flood 35°, D: Wide Flood 50°
Surface Finish	W: Snow White, V: Ivory White, S: Radiant Silver, B: Jet Black, H: Anodic Champagne
Control Gear	E: On/Off, L: DALI, H: Touch-Dim
Colour Rendering	9: CRI>90
Colour Temperature	27: 2700K, 30: 3000K, 40: 4000K
Led-Engine	F: Eco [Ra> 90], A: Artist [Ra> 97, Xicato]
Power	E: Low Power, M: Medium Power
Optic Ring	W: Snow White, V: Ivory White, S: Radiant Silver, B: Jet Black, H: Anodic Champagne, G: Satin Gold, K: Satin Copper
Cover	K: Clear Cover [Standard], P: Prismatic Lens, H: Honeycomb Louvre
On Request	Optic Removal Tool for clear cover



Spot 10° Led Engine Eco, Medium Power

Mounting Height	Illuminance[Lux] center/side	Beam Diameter
4 m	820/405	0.95 m
3 m	1457/721	0.72 m
2 m	3279/1622	0.48 m
1 m	13117/6488	0.24 m
1 m	13117/6488	0.24 m
2 m	3279/1622	0.48 m
3 m	1457/721	0.72 m
4 m	820/405	0.95 m

LED Engine	2700K	3000K	4000K
Eco Low			
Power [27W]	1840 lm	2020 lm	2160 lm
Eco Medium			
Power [39W]	2460 lm	2700 lm	2880 lm
Artist Low			
Power [26W]	1560 lm	1640 lm	1780 lm
Artist Medium			
Power [38W]	2080 lm	2180 lm	2380 lm

Medium 20° Led Engine Eco, Medium Power

Mounting Height	Illuminance[Lux] center/side	Beam Diameter
4 m	697/340	1.30 m
3 m	1240/604	0.96 m
2 m	2790/1359	0.64 m
1 m	11159/5436	0.32 m
1 m	11159/5436	0.32 m
2 m	2790/1359	0.64 m
3 m	1240/604	0.96 m
4 m	697/340	1.30 m

LED Engine	2700K	3000K	4000K
Eco Low			
Power [27W]	2400 lm	2640 lm	2820 lm
Eco Medium			
Power [39W]	3160 lm	3480 lm	3700 lm
Artist Low			
Power [26W]	2020 lm	2120 lm	2300 lm
Artist Medium			
Power [38W]	2660 lm	2780 lm	3020 lm

Flood 35° Led Engine Eco, Medium Power

Mounting Height	Illuminance[Lux] center/side	Beam Diameter
4 m	248/108	2.50 m
3 m	441/191	1.90 m
2 m	991/430	1.30 m
1 m	3965/1721	0.63 m
1 m	3965/1721	0.63 m
2 m	991/430	1.30 m
3 m	441/191	1.90 m
4 m	248/108	2.50 m

LED Engine	2700K	3000K	4000K
Eco Low			
Power [27W]	2360 lm	2580 lm	2760 lm
Eco Medium			
Power [39W]	3060 lm	3360 lm	3580 lm
Artist Low			
Power [26W]	1980 lm	2080 lm	2260 lm
Artist Medium			
Power [38W]	2580 lm	2700 lm	2940 lm

Wide Flood 50° Led Engine Eco, Medium Power

Mounting Height	Illuminance[Lux] center/side	Beam Diameter
4 m	163/64	3.80 m
3 m	289/114	2.80 m
2 m	651/256	1.90 m
1 m	2605/1022	0.94 m
1 m	2605/1022	0.94 m
2 m	651/256	1.90 m
3 m	289/114	2.80 m
4 m	163/64	3.80 m

LED Engine	2700K	3000K	4000K
Eco Low			
Power [27W]	2300 lm	2520 lm	2680 lm
Eco Medium			
Power [39W]	2880 lm	3160 lm	3360 lm
Artist Low			
Power [26W]	2000 lm	2100 lm	2280 lm
Artist Medium			
Power [38W]	2500 lm	2620 lm	2860 lm



W Snow White
W Snow White



W Snow White
B Jet Black



S Radiant Silver
G Satin Gold



S Radiant Silver
B Jet Black



H Anodic Champagne
B Jet Black



B Jet Black
G Satin Gold



Optic Removal Tool for clear cover



Honeycomb Louvre



Prismatic Lens

Basic Superflat X7/Y7 | Wall

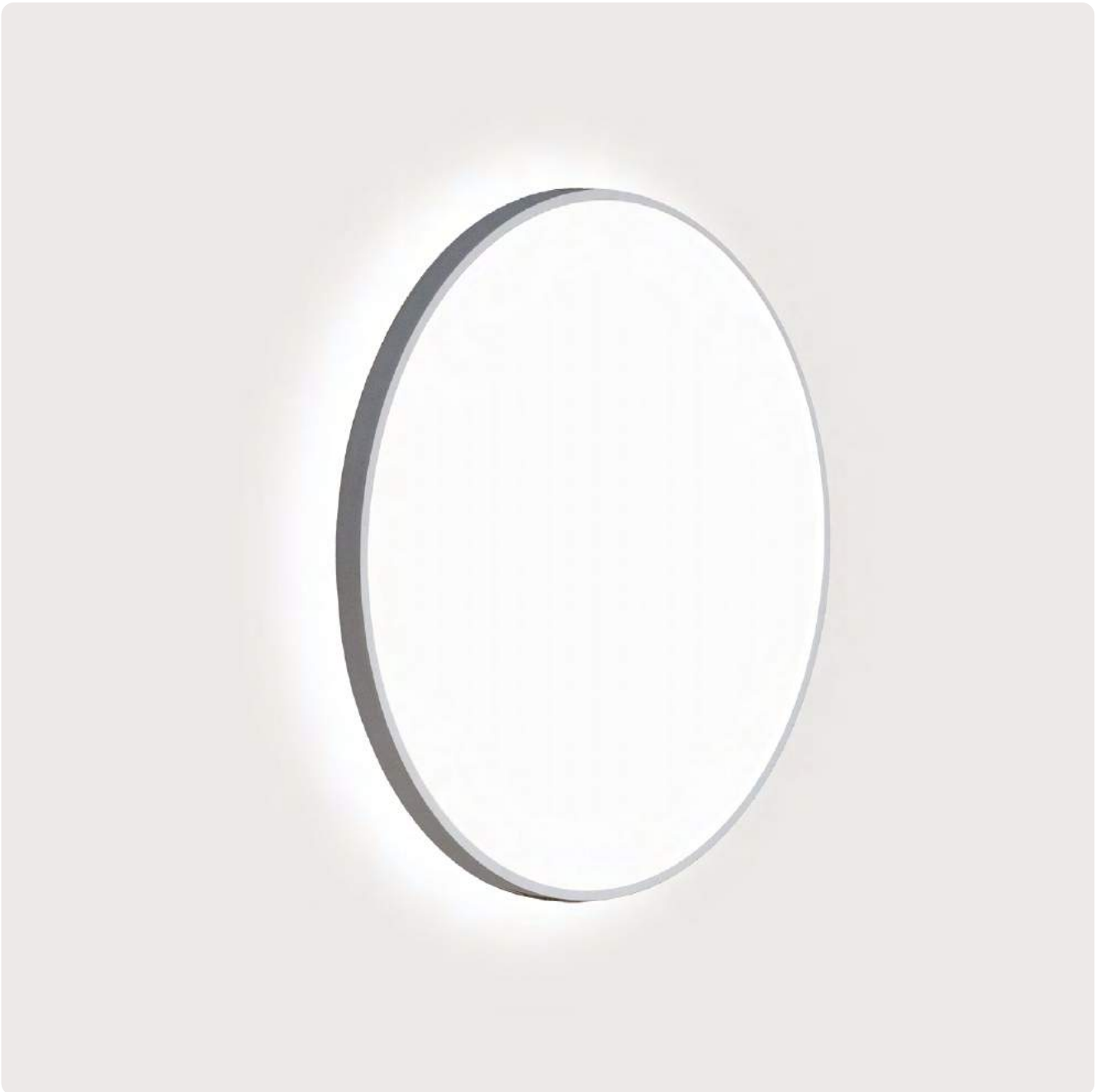

DE LED-Anbauleuchte für Wand- oder Deckenmontage. Direktstrahlend mit indirekter Lichtkorona oder rein direktstrahlend. Gestufter Leuchtenkörper aus Aluminiumprofil mit lediglich 18 mm sichtbarem Rahmenprofil. Oberfläche weiß, silber, graphit, schwarz, champagner oder kupferfarben lackiert. Weitere Oberflächenoptionen siehe Lightnet-Surface-Collection oder RAL nach Wahl. Microprismenoptik mit optimierter Blendungsbegrenzung speziell für Office-Anwendungen. Satinierter Opal diffuser für Allgemeinbeleuchtung mit max. Transmissionsgrad und homogener Lichtpunktauflösung. Konverter in Leuchtengehäuse integriert, wahlweise einfach schaltbar oder stufenlos dimmbar (DALI, Touch-Dim, Casambi). Farbtemperatur 2200K, 2700K, 3000K, 3500K, 4000K, 6500K oder Tunable White (2700-6500K). Binning initial \leq MacAdam 3. Farbwiedergabe CRI > 80, CRI > 90 oder Full Spectrum. Auf Anfrage: Integration von Notlichtkomponenten.

EN LED surface-mounted luminaire for walls or ceilings. Direct light distribution and indirect lighting corona or direct only light distribution. Tiered luminaire body made of aluminium profile with 18 mm visible frame. Surface white, silver, graphite, black, champagne or copper coated. Further surface options see Lightnet-Surface-Collection or RAL of your choice. Microprismatic screen with optimized glare reduction especially for workplaces. Satin opal diffuser for general lighting with maximum transmittance and homogeneous lighting. Driver integrated into luminaire housing, optionally switchable or dimmable (DALI, Touch-Dim, Casambi). Colour temperature 2200K, 2700K, 3000K, 3500K, 4000K, 6500K or Tunable White (2700-6500K). Binning \leq MacAdam 3. Colour rendering CRI > 80, CRI > 90 or Full Spectrum. On request: Integration of emergency lighting components.

BX7 O S L-8 30 M-D400

- Product Family **B:** Basic
- Type **X7:** Direct-Indirect, **Y7:** Direct only
- Optical System **A:** Microprismatic, **O:** Opal Diffuser
- Surface Finish **W:** Snow White, **V:** Ivory White, **S:** Radiant Silver, **U:** Urban Graphite, **B:** Jet Black, **H:** Anodic Champagne, **K:** Satin Copper
- Control Gear **E:** On/Off, **L:** DALI, **H:** Touch-Dim, **6:** DALI DT6 for TW, **8:** DALI DT8 for TW, **C:** Casambi [D400-D800]
- Colour Rendering **8:** CRI>80, **9:** CRI>90, **F:** Full Spectrum [except 2200K]
- Colour Temperature **22:** 2200K, **27:** 2700K, **30:** 3000K, **35:** 3500K, **40:** 4000K, **65:** 6500K, **TW:** Tunable White 2700-6500K [D400-D800]
- Power **M:** Medium Power, **H:** High Power
- Size Luminaire Diameter in mm: **D300, D400, D500, D600, D800**
- On Request Emergency Module [D400-D800]



Microprismatic | Direct-Indirect

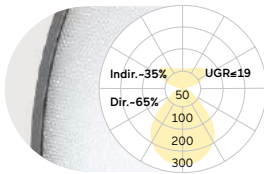

D mm	Lumen/Watt Medium Power	Lumen/Watt High Power
300	1260lm/11W	2150lm/18W
400	2330lm/18W	4050lm/31W
500	3000lm/23W	5240lm/40W
600	5380lm/40W	8270lm/63W
800	7860lm/60W	10750lm/81W

Microprismatic | Direct

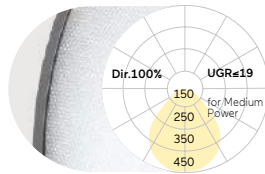

D mm	Lumen/Watt Medium Power	Lumen/Watt High Power
300	690lm/7W	1190lm/11W
400	1470lm/12W	2560lm/21W
500	2030lm/16W	3570lm/28W
600	3390lm/25W	5520lm/42W
800	5160lm/40W	6980lm/54W

Opal Diffuser | Direct-Indirect

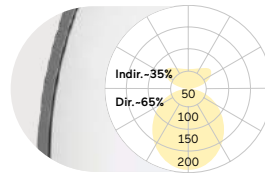

D mm	Lumen/Watt Medium Power	Lumen/Watt High Power
300	1270lm/11W	2160lm/18W
400	2350lm/18W	4070lm/31W
500	3040lm/23W	5300lm/40W
600	5450lm/40W	8370lm/63W
800	7980lm/60W	10920lm/81W

Opal Diffuser | Direct

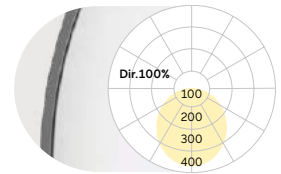

D mm	Lumen/Watt Medium Power	Lumen/Watt High Power
300	700lm/7W	1200lm/11W
400	1490lm/12W	2580lm/21W
500	2070lm/16W	3630lm/28W
600	3460lm/25W	5620lm/42W
800	5280lm/40W	7150lm/54W

Lumen Values: Luminaire luminous flux at 4000K/CRI>80. Other configurations on request.

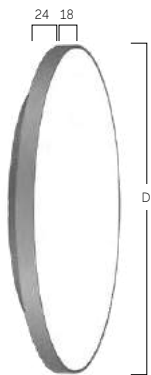

Emergency Module



W Snow White



S Radiant Silver



U Urban Graphite



B Jet Black



H Anodic Champagne



K Satin Copper

Basic Neo W5 | Wall



DE LED-Wand-Anbauleuchte. Direkt-indirektstrahlend. Leuchtenkörper aus Aluminiumprofil. Oberfläche weiß, silber, graphit, schwarz, champagner oder kupferfarben lackiert. Weitere Oberflächenoptionen siehe Lightnet-Surface-Collection oder RAL nach Wahl. Microprismenoptik mit optimierter Blendungsbegrenzung speziell für Office-Anwendungen. Satiniertes Opaldiffusor für Allgemeinbeleuchtung mit max. Transmissionsgrad und homogener Lichtpunktauflösung. Konverter in Leuchtengehäuse integriert, wahlweise einfach schaltbar oder stufenlos dimmbar (DALI, Touch-Dim). Farbtemperatur 2200K, 2700K, 3000K, 3500K, 4000K oder 6500K. Binning initial \leq MacAdam 3. Farbwiedergabe CRI>80, CRI>90 oder Full Spectrum.

EN LED wall mounted luminaire. Direct-indirect light distribution. Luminaire body made of aluminum profile. Surface white, silver, graphite, black, champagne or copper coated. Further surface options see Lightnet-Surface-Collection or RAL of your choice. Microprismatic screen with optimized glare reduction especially for workplaces. Satin opal diffuser for general lighting with maximum transmittance and homogeneous lighting. Driver integrated into luminaire housing, optionally switchable or dimmable (DALI, Touch-Dim). Colour temperature 2200K, 2700K, 3000K, 3500K, 4000K or 6500K. Binning \leq MacAdam 3. Colour rendering CRI>80, CRI>90 or Full Spectrum.

B W5 O S L - 8 30 M-D300

Product Family	B: Basic
Type	W5: Direct-Indirect
Optical System	A: Microprismatic, O: Opal Diffuser
Surface Finish	W: Snow White, V: Ivory White, S: Radiant Silver, U: Urban Graphite, B: Jet Black, H: Anodic Champagne, K: Satin Copper
Control Gear	E: On/Off, L: DALI, H: Touch-Dim
Colour Rendering	8: CRI>80, 9: CRI>90, F: Full Spectrum [except 2200K]
Colour Temperature	22: 2200K, 27: 2700K, 30: 3000K, 35: 3500K, 40: 4000K, 65: 6500K
Power	M: Medium Power, H: High Power
Size	Luminaire Diameter in mm: D300



Microprismatic | Direct-Indirect

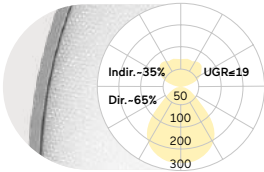

Opal Diffuser | Direct-Indirect

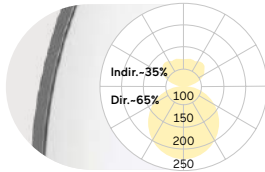

D mm	Lumen/Watt Medium Power	Lumen/Watt High Power
300	1210lm/11W	2070lm/18W

D mm	Lumen/Watt Medium Power	Lumen/Watt High Power
300	1220lm/11W	2080lm/18W

Lumen Values: Luminaire luminous flux at 4000K/CRI>80. Other configurations on request.

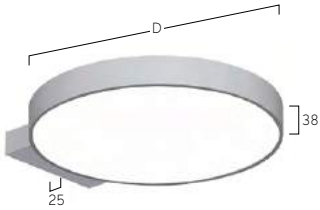

W Snow White



S Radiant Silver



U Urban Graphite



B Jet Black



H Anodic Champagne



K Satin Copper

Basic Neo Y5/X5 | Wall



DE LED-Anbauleuchte für Wand- oder Deckenmontage. Direktstrahlend mit indirekter Lichtkorona oder rein direktstrahlend. Oberfläche weiß, silber, graphit, schwarz, champagner oder kupferfarben lackiert. Weitere Oberflächenoptionen siehe Lightnet-Surface-Collection oder RAL nach Wahl. Microprismenoptik mit optimierter Blendungsbegrenzung speziell für Office-Anwendungen. Satinierter Opaldiffusor für Allgemeinbeleuchtung mit max. Transmissionsgrad und homogener Lichtpunktauflösung. Konverter in Leuchtgehäuse integriert, wahlweise einfach schaltbar oder stufenlos dimmbar (DALI, Touch-Dim, Casambi). Farbtemperatur 2200K, 2700K, 3000K, 3500K, 4000K, 6500K oder Tunable White (2700-6500K). Binning initial \leq MacAdam 3. Farbwiedergabe CRI > 80, CRI > 90 oder Full Spectrum. Auf Anfrage: Integration von Notlichtkomponenten.

EN LED surface-mounted luminaire for walls or ceilings. Direct light distribution and indirect lighting corona or direct only light distribution. Surface white, silver, graphite, black, champagne or copper coated. Further surface options see Lightnet-Surface-Collection or RAL of your choice. Micro-prismatic screen with optimized glare reduction especially for workplaces. Satin opal diffuser for general lighting with maximum transmittance and homogeneous lighting. Driver integrated into luminaire housing, optionally switchable or dimmable (DALI, Touch-Dim, Casambi). Colour temperature 2200K, 2700K, 3000K, 3500K, 4000K, 6500K or Tunable White (2700-6500K). Binning \leq MacAdam 3. Colour rendering CRI > 80, CRI > 90 or Full Spectrum. On request: Integration of emergency lighting components.

B X5 O SL - 8 30 M-D500

- Product Family **B:** Basic
- Type **Y5:** Direct Only, **X5:** Direct-Indirect
- Optical System **A:** Microprismatic, **O:** Opal Diffuser
- Surface Finish **W:** Snow White, **V:** Ivory White, **S:** Radiant Silver, **U:** Urban Graphite, **B:** Jet Black, **H:** Anodic Champagne, **K:** Satin Copper
- Control Gear **E:** On/Off, **L:** DALI, **H:** Touch-Dim, **6:** DALI DT6 for TW, **8:** DALI DT8 for TW, **C:** Casambi [D400-D800]
- Colour Rendering **8:** CRI>80, **9:** CRI>90, **F:** Full Spectrum [except 2200K]
- Colour Temperature **22:** 2200K, **27:** 2700K, **30:** 3000K, **35:** 3500K, **40:** 4000K, **65:** 6500K, **TW:** Tunable White 2700-6500K [D400-D800]
- Power **M:** Medium Power, **H:** High Power
- Size Luminaire Diameter in mm: **D300, D400, D500, D600, D800**
- On Request Emergency Module [D400-D800]



Microprismatic Direct-Indirect			Microprismatic Direct			Opal Diffuser Direct-Indirect			Opal Diffuser Direct		
D	Lumen/Watt	Lumen/Watt	D	Lumen/Watt	Lumen/Watt	D	Lumen/Watt	Lumen/Watt	D	Lumen/Watt	Lumen/Watt
mm	Medium Power	High Power	mm	Medium Power	High Power	mm	Medium Power	High Power	mm	Medium Power	High Power
300	1210lm/11W	2070lm/18W	300	690lm/7W	1190lm/11W	300	1220lm/11W	2080lm/18W	300	700lm/7W	1200lm/11W
400	2260lm/18W	3920lm/31W	400	1470lm/12W	2560lm/21W	400	2280lm/18W	3940lm/31W	400	1490lm/12W	2580lm/21W
500	2920lm/23W	5100lm/40W	500	2030lm/16W	3570lm/28W	500	2960lm/23W	5160lm/40W	500	2070lm/16W	3630lm/28W
600	5210lm/40W	8040lm/63W	600	3390lm/25W	5520lm/42W	600	5280lm/40W	8140lm/63W	600	3460lm/25W	5620lm/42W
800	7630lm/60W	10430lm/81W	800	5160lm/40W	6980lm/54W	800	7750lm/60W	10600lm/81W	800	5280lm/40W	7150lm/54W

Lumen Values: Luminaire luminous flux at 4000K/CRI>80. Other configurations on request.

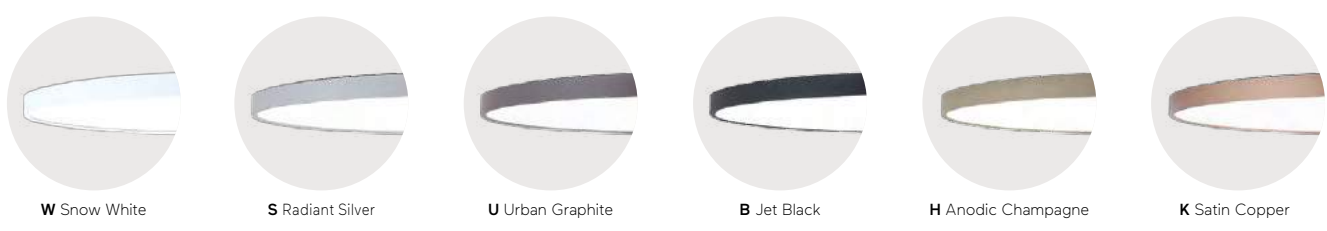
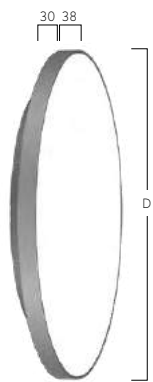

Basic Déco Y3/X3 | Wall



DE LED-Anbauleuchte für Wand- und Deckenmontage. Direktstrahlend mit indirekter Lichtkorona oder rein direktstrahlend. Leuchtenkörper aus Aluminiumprofil. Gehäuse-Außenfläche und Innendekor in unterschiedlichen Lackierungen und Kombinationen erhältlich, z.B. weiß, silber, graphit, schwarz, gold oder kupferfarben. Zu Oberflächenoptionen- und Kombinationen siehe Lightnet-Surface-Collection oder Bi-Colour-Auswahl. Rückversetzte Microprismenoptik mit optimierter Blendungsbegrenzung speziell für Office-Anwendungen. Satinierter Opaldiffusor für Allgemeinbeleuchtung mit max. Transmissionsgrad und homogener Lichtpunktauflösung. Konverter in Leuchtgehäuse integriert, wahlweise einfach schaltbar oder stufenlos dimmbar (DALI, Touch-Dim, Casambi). Farbtemperatur 2200K, 2700K, 3000K, 3500K, 4000K, 6500K oder Tunable White (2700-6500K). Binning initial \leq MacAdam 3. Farbwiedergabe CRI>80, CRI>90 oder Full Spectrum. Auf Anfrage: Integration von Notlichtkomponenten.

EN LED surface-mounted luminaire for walls and ceilings. Direct light distribution and indirect lighting corona or direct only light distribution. Luminaire body made of aluminum profile. Outer housing and inner decor available in various finishes and combinations, e.g. white, silver, graphite, black, gold or copper coated. Further surface options see Lightnet-Surface-Collection or RAL of your choice. Recessed microprismatic screen with optimized glare reduction especially for workplaces. Satin opal diffuser for general lighting with maximum transmittance and homogeneous lighting. Driver integrated into luminaire housing, optionally switchable or dimmable (DALI, Touch-Dim, Casambi). Colour temperature 2200K, 2700K, 3000K, 3500K, 4000K, 6500K or Tunable White (2700-6500K). Binning \leq MacAdam 3. Colour rendering CRI>80, CRI>90 or Full Spectrum. On request: Integration of emergency lighting components.

BY3 O S L - 8 30 M-D400-S

Product Family	B: Basic
Type	Y3: Direct Only, X3: Direct-Indirect
Optical System	A: Microprismatic, O: Opal Diffuser
Surface Finish	W: Snow White, V: Ivory White, S: Radiant Silver, U: Urban Graphite, B: Jet Black, H: Anodic Champagne, K: Satin Copper
Control Gear	E: On/Off, L: DALI, H: Touch-Dim, 6: DALI DT6 for TW, 8: DALI DT8 for TW, C: Casambi [D400-D800]
Colour Rendering	8: CRI>80, 9: CRI>90, F: Full Spectrum [except 2200K]
Colour Temperature	22: 2200K, 27: 2700K, 30: 3000K, 35: 3500K, 40: 4000K, 65: 6500K, TW: Tunable White 2700-6500K [D400-D800]
Power	M: Medium Power, H: High Power
Size	Luminaire Diameter in mm: D300, D400, D500, D600, D800
Reflector	W: Snow White, V: Ivory White, S: Radiant Silver, U: Urban Graphite, B: Jet Black, H: Anodic Champagne, K: Satin Copper, G: Satin Gold
On Request	Emergency Module [D400-D800]



Microprismatic Direct-Indirect			Microprismatic Direct			Opal Diffuser Direct-Indirect			Opal Diffuser Direct		
D mm	Lumen/Watt Medium Power	Lumen/Watt High Power	D mm	Lumen/Watt Medium Power	Lumen/Watt High Power	D mm	Lumen/Watt Medium Power	Lumen/Watt High Power	D mm	Lumen/Watt Medium Power	Lumen/Watt High Power
300	1480lm/13W	2530lm/23W	300	830lm/8W	1430lm/13W	300	1460lm/13W	2500lm/23W	300	810lm/8W	1400lm/13W
400	2370lm/20W	3750lm/31W	400	1500lm/14W	2410lm/21W	400	2370lm/20W	3750lm/31W	400	1500lm/14W	2410lm/21W
500	3500lm/29W	5810lm/48W	500	2370lm/21W	3980lm/35W	500	3520lm/29W	5870lm/48W	500	2390lm/21W	4040lm/35W
600	5380lm/43W	7750lm/63W	600	3560lm/28W	5230lm/42W	600	5470lm/43W	7850lm/63W	600	3650lm/28W	5330lm/42W
800	7830lm/63W	9940lm/82W	800	5360lm/44W	6490lm/55W	800	7980lm/63W	10110lm/82W	800	5510lm/44W	6660lm/55W

Lumen Values: Luminaire luminous flux at 4000K/CRI>80. Other configurations on request.



Basic Visio Y9/X9 | Wall



DE LED-Anbauleuchte für Wand- oder Deckenmontage. Direkt- rundumstrahlend für dezente Wand- bzw. Deckenaufhellung oder direkt-indirektstrahlend stärkere indirekte Lichtkorona. Leuchtenkörper aus gegossenem Acrylgas. Wahlweise Microprismenoptik mit optimierter Blendungsbegrenzung speziell für Office-Anwendungen oder satinierter Opaldiffusor für Allgemeinbeleuchtung mit max. Transmissionsgrad und homogener Lichtpunktauflösung. Distanzelement und Optikträger wahlweise weiß oder graphitfarben. Konverter in Leuchtengehäuse integriert, wahlweise einfach schaltbar oder stufenlos dimmbar (DALI, Touch-Dim, Casambi). Farbtemperatur 2200K, 2700K, 3000K, 3500K, 4000K, 6500K oder Tunable White (2700-6500K). Binning initial \leq MacAdam 3. Farbwiedergabe CRI>80, CRI>90 oder Full Spectrum. Auf Anfrage: Integration von Notlichtkomponenten.

EN LED surface-mounted luminaire for walls or ceilings. Direct-omnidirectional light distribution for soft wall or ceiling illumination or direct-indirect light distribution for stronger indirect light distribution. Luminaire body made of cast acrylic glass. Available with microprismatic screen with optimized glare reduction especially for workplaces or satin opal diffuser for general lighting with maximum transmittance and homogeneous lighting. Spacers and backplate optionally white or graphite coated. Driver integrated into luminaire housing, optionally switchable or dimmable (DALI, Touch-Dim, Casambi). Colour temperature 2200K, 2700K, 3000K, 3500K, 4000K, 6500K or Tunable White (2700-6500K). Binning \leq MacAdam 3. Colour rendering CRI>80, CRI>90 or Full Spectrum. On request: Integration of emergency lighting components.

B X9 O WE - 8 30 M-D300

Product Family	B: Basic
Type	Y9: Direct Only, X9: Direct-Indirect
Optical System	A: Microprismatic, O: Opal Diffuser
Surface Finish	W: Snow White, U: Urban Graphite
Control Gear	E: On/Off, L: DALI, H: Touch-Dim, C: Casambi, 6: DALI DT6 for TW, 8: DALI DT8 for TW
Colour Rendering	8: CRI>80, 9: CRI>90, F: Full Spectrum [except 2200K]
Colour Temperature	22: 2200K, 27: 2700K, 30: 3000K, 35: 3500K, 40: 4000K, 65: 6500K, TW: Tunable White 2700-6500K [D400-D610]
Power	M: Medium Power, H: High Power
Size	Luminaire Diameter in mm: D300, D400, D500, D610



Microprismatic | Direct-Indirect

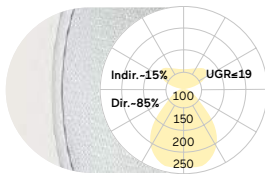

D mm	Lumen/Watt Medium Power	Lumen/Watt High Power
300	760lm/6W	1200lm/10W
400	1770lm/14W	3090lm/23W
500	2840lm/21W	5230lm/38W
610	3830lm/28W	7100lm/52W

Microprismatic | Direct

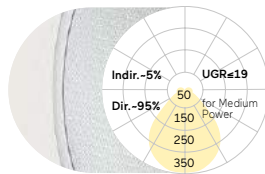

D mm	Lumen/Watt Medium Power	Lumen/Watt High Power
300	630lm/5W	1000lm/9W
400	1630lm/13W	2840lm/22W
500	2470lm/19W	4560lm/34W
610	3340lm/25W	6200lm/46W

Opal Diffuser | Direct-Indirect

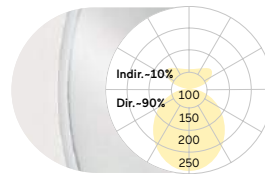

D mm	Lumen/Watt Medium Power	Lumen/Watt High Power
300	800lm/6W	1260lm/10W
400	1870lm/14W	3270lm/23W
500	2990lm/21W	5500lm/38W
610	4040lm/28W	7470lm/52W

Opal Diffuser | Direct

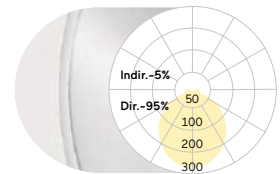

D mm	Lumen/Watt Medium Power	Lumen/Watt High Power
300	670lm/5W	1060lm/9W
400	1730lm/13W	3020lm/22W
500	2620lm/19W	4830lm/34W
610	3550lm/25W	6570lm/46W

Lumen Values: Luminaire luminous flux at 4000K/CRI>80. Other configurations on request.



W Snow White



U Urban Graphite

Liquid Line W5 | Compact Wall



DE LED-Wandanbauleuchte. Direkt-indirektstrahlend. Leuchtenkörper mit feinen Radien aus Aluminium gefertigt aus einem Guss ohne sichtbare Nahtstellen an den Stirnseiten. Oberfläche weiß, silber, graphit, schwarz oder champagnerfarben lackiert. Weitere Oberflächenoptionen siehe Lightnet-Surface-Collection oder RAL nach Wahl. Satinierter Opaldiffusor für Allgemeinbeleuchtung mit max. Transmissionsgrad und homogener Lichtpunktauflösung. Konverter in Leuchtgehäuse integriert, wahlweise einfach schaltbar oder stufenlos dimmbar (DALI). Farbtemperatur 2200K, 2700K, 3000K, 4000K oder 6500K. Binning initial \leq MacAdam 3. Farbwiedergabe CRI $>$ 80.

EN LED wall mounted luminaire. Direct-indirect light distribution. Luminaire body with smooth curves made of aluminium crafted in one piece with no visible seams. Surface white, silver, graphite, black or champagne coated. Further surface options see Lightnet-Surface-Collection or RAL of your choice. Satin opal diffuser for general lighting with maximum transmittance and homogeneous lighting. Driver integrated into luminaire housing, optionally switchable or dimmable (DALI). Colour temperature 2200K, 2700K, 3000K, 4000K or 6500K. Binning \leq MacAdam 3. Colour rendering CRI $>$ 80.

Q W5 O W E-8 30 H-L139

Product Family	Q: Liquid Line
Type	W5: Direct-Indirect
Optical System	O: Opal Diffuser
Surface Finish	W: Snow White, V: Ivory White, S: Radiant Silver, U: Urban Graphite, B: Jet Black, H: Anodic Champagne, K: Satin Copper
Control Gear	E: On/Off, L: DALI, H: Touch-Dim
Colour Rendering	8: CRI>80, 9: CRI>90, F: Full Spectrum [except 2200K]
Colour Temperature	22: 2200K, 27: 2700K, 30: 3000K, 35: 3500K, 40: 4000K, 65: 6500K
Power	H: High Power
Size	Luminaire Length in mm: L139



Opal Diffuser | Direct-Indirect

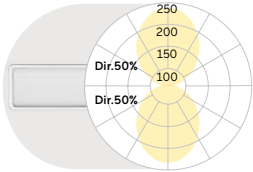

L mm	Lumen/Watt High Power
139	1440lm/16W

Lumen Values: Luminaire luminous flux at 4000K/CRI>80. Other configurations on request.

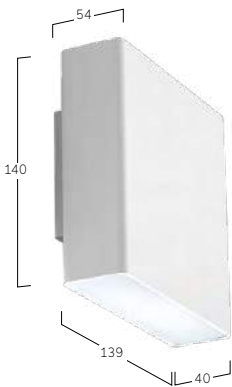

Liquid Line WX | System 40 mm Wall



DE LED-Wandanbauleuchte. Direkt-indirektstrahlend. Leuchtenkörper mit feinen Radien aus Aluminium, gefertigt aus einem Guss ohne sichtbare Nahtstellen an den Stirnseiten. Oberfläche weiß, silber, graphit, schwarz oder champagnerfarben lackiert. Weitere Oberflächenoptionen siehe Lightnet-Surface-Collection oder RAL nach Wahl. Satinierter Opaldiffusor für Allgemeinbeleuchtung mit max. Transmissionsgrad und homogener Lichtpunktauflösung. Konverter in Leuchtengehäuse integriert, wahlweise einfach schaltbar oder stufenlos dimmbar (DALI). Farbtemperatur 2200K, 2700, 3000K, 4000K, 6500K oder Tunable White. Binning initial \leq MacAdam 3. Farbwiedergabe CRI $>$ 80. Auf Anfrage: Integration von Notlichtkomponenten.

EN LED wall mounted luminaire. Direct-indirect light distribution. Luminaire body with smooth curves made of aluminium, crafted in one piece with no visible seams at the ends. Surface white, silver, graphite, black or champagne coated. Further surface options see Lightnet-Surface-Collection or RAL of your choice. Satin opal diffuser for general lighting with maximum transmittance and homogeneous lighting. Driver integrated into luminaire housing, optionally switchable or dimmable (DALI). Colour temperature 2200K, 2700, 3000K, 4000K, 6500K or Tunable White. Binning \leq MacAdam 3. Colour rendering CRI $>$ 80. On request: Integration of emergency lighting components.

Q W X O W E - 8 30 M - L1182

- Product Family **Q:** Liquid Line
- Type **WX:** Direct-Indirect
- Optical System **O:** Opal Diffuser
- Surface Finish **W:** Snow White, **V:** Ivory White, **S:** Radiant Silver, **U:** Urban Graphite, **B:** Jet Black, **H:** Anodic Champagne, **K:** Satin Copper
- Control Gear **E:** On/Off, **L:** DALI, **H:** Touch-Dim, **C:** Casambi, **6:** DALI DT6 for TW [L1182-L2055], **8:** DALI DT8 for TW [L890-L2055]
- Colour Rendering **8:** CRI>80, **9:** CRI>90, **F:** Full Spectrum [except 2200K]
- Colour Temperature **22:** 2200K, **27:** 2700K, **30:** 3000K, **35:** 3500K, **40:** 4000K, **65:** 6500K, **TW:** Tunable White 2700-6500K
- Power **M:** Medium Power, **H:** High Power
- Size Luminaire Length in mm: **L600, L890, L1182, L1475, L1765, L2055**
- On Request Emergency Module [L1182-L2055]



Opal Diffuser | Direct-Indirect

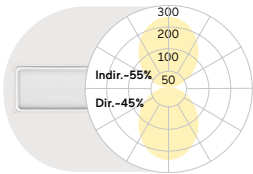

L mm	Lumen/Watt Medium Power	Lumen/Watt High Power
600	1840lm/17W	2420lm/23W
890	2850lm/26W	3740lm/33W
1182	3860lm/33W	5080lm/44W
1475	4870lm/41W	6410lm/54W
1765	5890lm/48W	7740lm/64W
2055	6910lm/59W	9070lm/78W

Lumen Values: Luminaire luminous flux at 4000K/CRI>80. Other configurations on request.

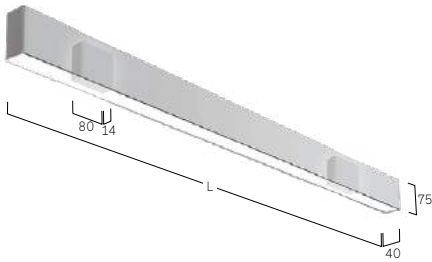

W Snow White



S Radiant Silver



U Urban Graphite



B Jet Black



H Anodic Champagne



K Satin Copper

Caleo Neo Y6/X6 | Wall



DE LED-Anbauleuchte für Wand- und Deckenmontage. Direktstrahlend mit indirekter Lichtkorona oder rein direktstrahlend. Leuchtenkörper aus Aluminium. Gehäuse-Außenfläche und dekorativer Reflektorring in unterschiedlichen Lackierungen und Kombinationen erhältlich, z.B. weiß, silber, graphit, schwarz, gold oder kupferfarben. Zu Oberflächenoptionen- und Kombinationen siehe Lightnet-Surface-Collection oder Bi-Colour-Auswahl. Rückversetzte Microprismenoptik mit optimierter Blendungsbegrenzung speziell für Office-Anwendungen. Satinierter Opaldiffusor für Allgemeinbeleuchtung mit max. Transmissionsgrad und homogener Lichtpunktauflösung. Konverter in Leuchtgehäuse integriert, wahlweise einfach schaltbar oder stufenlos dimmbar (DALI, Touch-Dim, Casambi). Farbtemperatur 2200K, 2700K, 3000K, 3500K, 4000K, 6500K oder Tunable White (2700-6500K). Binning initial \leq MacAdam 3. Farbwiedergabe CRI>80, CRI>90 oder Full Spectrum. Auf Anfrage: Integration von Notlichtkomponenten.

EN LED surface-mounted luminaire for walls and ceilings. Direct light distribution and indirect lighting corona or direct only light distribution. Luminaire body made of aluminium. Outer housing and Decorative reflector ring available in various finishes and combinations, e.g. white, silver, graphite, black, gold or copper coated. Further surface options see Lightnet-Surface-Collection or RAL of your choice. Recessed microprismatic screen with optimized glare reduction especially for workplaces. Satin opal diffuser for general lighting with maximum transmittance and homogeneous lighting. Driver integrated into luminaire housing, optionally switchable or dimmable (DALI, Touch-Dim, Casambi). Colour temperature 2200K, 2700K, 3000K, 3500K, 4000K, 6500K or Tunable White (2700-6500K). Binning \leq MacAdam 3. Colour rendering CRI>80, CRI>90 or Full Spectrum. On request: Integration of emergency lighting components.

A X6AWL-830H-Q500-G

Product Family **A:** Caleo

Type **X6:** Direct-Indirect, **Y6:** Direct-only

Optical System **A:** Microprismatic, **O:** Opal Diffuser

Surface Finish **W:** Snow White, **V:** Ivory White, **A:** Satin Silver, **U:** Urban Graphite, **B:** Jet Black, **H:** Anodic Champagne, **K:** Satin Copper

Control Gear **E:** On/Off, **L:** DALI, **H:** Touch-Dim, **6:** DALI DT6 for TW, **8:** DALI DT8 for TW

Colour Rendering **8:** CRI>80, **9:** CRI>90, **F:** Full Spectrum [except 2200K]

Colour Temperature **22:** 2200K, **27:** 2700K, **30:** 3000K, **35:** 3500K, **40:** 4000K, **65:** 6500K, **TW:** Tunable White 2700-6500K [Q500-Q800]

Power **M:** Medium Power, **H:** High Power

Size Square Size in mm: **Q300, Q400, Q500, Q600, Q800**

Reflector **W:** Snow White, **V:** Ivory White, **A:** Satin Silver, **U:** Urban Graphite, **B:** Jet Black, **H:** Anodic Champagne, **K:** Satin Copper, **G:** Satin Gold



Microprismatic Direct-Indirect			Microprismatic Direct			Opal Diffuser Direct-Indirect			Opal Diffuser Direct		
Q mm	Lumen/Watt Medium Power	Lumen/Watt High Power	Q mm	Lumen/Watt Medium Power	Lumen/Watt High Power	Q mm	Lumen/Watt Medium Power	Lumen/Watt High Power	Q mm	Lumen/Watt Medium Power	Lumen/Watt High Power
300	1990lm/17W	2700lm/22W	300	1230lm/11W	1670lm/15W	300	2000lm/17W	2720lm/22W	300	1240lm/11W	1690lm/15W
400	2930lm/23W	3890lm/31W	400	2060lm/18W	2720lm/23W	400	2950lm/23W	3910lm/31W	400	2080lm/18W	2740lm/23W
500	5140lm/39W	6720lm/52W	500	3180lm/26W	4180lm/35W	500	5170lm/39W	6760lm/52W	500	3210lm/26W	4220lm/35W
600	6790lm/54W	9230lm/73W	600	4800lm/39W	6480lm/53W	600	6830lm/54W	9290lm/73W	600	4840lm/39W	6540lm/53W
800	10780lm/86W	14900lm/121W	800	7720lm/65W	10450lm/90W	800	10840lm/86W	14990lm/121W	800	7780lm/65W	10540lm/90W

Lumen Values: Luminaire luminous flux at 4000K/CRI>80. Other configurations on request.

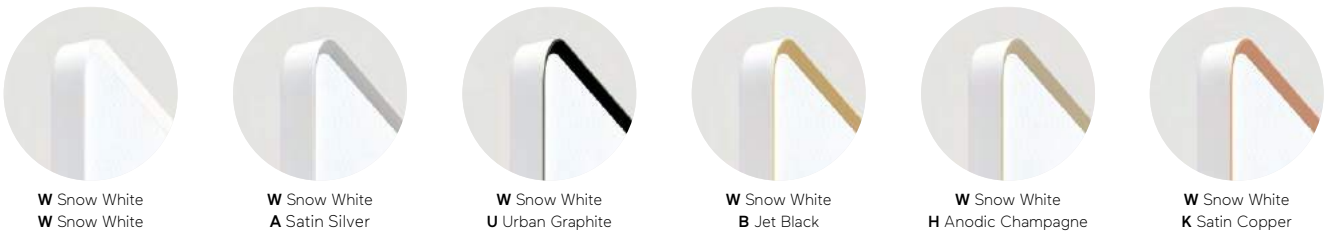
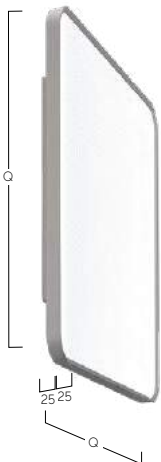

Cubic Wall





Satellite Office Opernplatz Frankfurt, Germany
Cubic W4
Photography: Moritz Bernouly, www.satelliteoffice.de



Cubic Evolution W4 | Wall



DE LED-Wandanbauleuchte. Direkt-indirektstrahlend. Leuchtenkörper in minimalistischer Bauhöhe aus Aluminiumprofil. Oberfläche natureloxiert oder weiß, graphit, schwarz bzw. champagnerfarben lackiert. Weitere Oberflächenoptionen siehe Lightnet-Surface-Collection oder RAL nach Wahl. Microprismenoptik mit optimierter Blendungsbegrenzung speziell für Office-Anwendungen. Satinierter Opaldiffusor für Allgemeinbeleuchtung mit max. Transmissionsgrad und homogener Lichtpunktauflösung. Konverter in Leuchtgehäuse integriert, wahlweise einfach schaltbar oder stufenlos dimmbar (DALI, Touch-Dim, Casambi). Farbtemperatur 2700K, 3000K, 3500K, 4000K oder 6500K. Binning initial \leq MacAdam 3. Farbwiedergabe CRI $>$ 80, CRI $>$ 90 oder Full Spectrum.

EN LED wall mounted luminaire. Direct-indirect light distribution. Luminaire body with minimalist overall height made of aluminium profile. Surface natural anodised or white, graphite, black or champagne coated. Further surface options see Lightnet-Surface-Collection or RAL of your choice. Microprismatic screen with optimized glare reduction especially for workplaces. Satin opal diffuser for general lighting with maximum transmittance and homogeneous lighting. Driver integrated into luminaire housing, optionally switchable or dimmable (DALI, Touch-Dim, Casambi). Colour temperature 2700K, 3000K, 3500K, 4000K or 6500K. Binning \leq MacAdam 3. Colour rendering CRI $>$ 80, CRI $>$ 90 or Full Spectrum.

C W4 A B E - 8 30 M - L600

Product Family	C: Cubic
Type	W4: Direct-Indirect
Optical System	A: Microprismatic, O: Opal Diffuser
Surface Finish	W: Snow White, E: Silver Anodised, U: Urban Graphite, B: Jet Black, H: Anodic Champagne
Control Gear	E: On/Off, L: DALI, H: Touch-Dim
Colour Rendering	8: CRI>80, 9: CRI>90, F: Full Spectrum [except 2200K]
Colour Temperature	22: 2200K, 27: 2700K, 30: 3000K, 35: 3500K, 40: 4000K, 65: 6500K
Power	M: Medium Power
Size	Luminaire Length in mm: L600



Microprismatic | Direct-Indirect

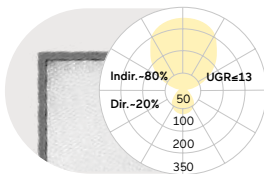

L	Lumen/Watt
mm	Medium Power
600	6550lm/47W

Opal Diffuser | Direct-Indirect

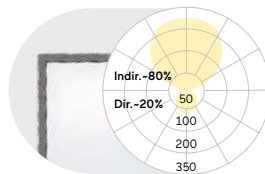

L	Lumen/Watt
mm	Medium Power
600	6510lm/47W

Lumen Values: Luminaire luminous flux at 4000K/CRI>80. Other configurations on request.

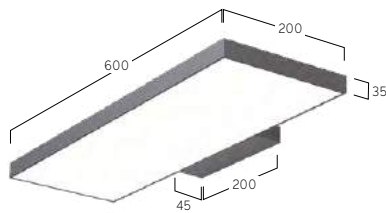

W Snow White



E Silver Anodised



U Urban Graphite



B Jet Black



H Anodic Champagne

Cubic Evolution Y6/X6 | Wall



DE LED-Anbauleuchte für Wand- oder Deckenmontage. Direktstrahlend mit indirekter Lichtkorona oder rein direktstrahlend. Gestufter Leuchtenkörper aus Aluminiumprofil mit lediglich 25mm sichtbarem Rahmenprofil. Oberfläche natureloxiert oder weiß, graphit, schwarz bzw. champagnerfarben lackiert. Weitere Oberflächenoptionen siehe Lightnet-Surface-Collection oder RAL nach Wahl. Microprismenoptik mit optimierter Blendungsbegrenzung speziell für Office-Anwendungen. Satinierter Opaldiffusor für Allgemeinbeleuchtung mit max. Transmissionsgrad und homogener Lichtpunktauflösung. Konverter in Leuchtgehäuse integriert, wahlweise einfach schaltbar oder stufenlos dimmbar (DALI, Touch-Dim, Casambi). Farbtemperatur 2700K, 3000K, 3500K 4000K, 6500K oder Tunable White. Binning initial \leq MacAdam 3. Farbwiedergabe CRI $>$ 80, CRI $>$ 90 oder Full Spectrum. Auf Anfrage: Integration von Notlichtkomponenten, Sensortechnologie.

EN LED surface-mounted luminaire for walls or ceilings. Direct light distribution and indirect lighting corona or direct only light distribution. Tiered luminaire body made of aluminium profile with only 25mm visible frame. Surface natural anodised or white, graphite, black or champagne coated. Further surface options see Lightnet-Surface-Collection or RAL of your choice. Microprismatic screen with optimized glare reduction especially for workplaces. Satin opal diffuser for general lighting with maximum transmittance and homogeneous lighting. Driver integrated into luminaire housing, optionally switchable or dimmable (DALI, Touch-Dim, Casambi). Colour temperature 2700K, 3000K, 3500K 4000K, 6500K or Tunable White. Binning \leq MacAdam 3. Colour rendering CRI $>$ 80, CRI $>$ 90 or Full Spectrum. On request: Integration of emergency lighting components, sensor technology.

C Y6 A B E - 8 30 M - Q600

Product Family **C:** Cubic

Type **Y6:** Direct-only, **X6:** Direct-Indirect

Optical System **A:** Microprismatic, **O:** Opal Diffuser

Surface Finish **W:** Snow White, **E:** Silver Anodised, **U:** Urban Graphite, **B:** Jet Black, **H:** Anodic Champagne

Control Gear **E:** On/Off, **L:** DALI, **H:** Touch-Dim, **C:** Casambi, **6:** DALI DT6 for TW, **8:** DALI DT8 for TW

Colour Rendering **8:** CRI>80, **9:** CRI>90, **F:** Full Spectrum [except 2200K]

Colour Temperature **22:** 2200K, **27:** 2700K, **30:** 3000K, **35:** 3500K, **40:** 4000K, **65:** 6500K, **TW:** Tunable White 2700-6500K [Q400-Q800]

Power **M:** Medium Power, **H:** High Power

Size Square Size in mm: **Q300, Q400, Q500, Q600, Q800**

On Request Emergency Module [Q400-Q800]



Microprismatic Direct-Indirect			Microprismatic Direct			Opal Diffuser Direct-Indirect			Opal Diffuser Direct		
Q mm	Lumen/Watt Medium Power	Lumen/Watt High Power	Q mm	Lumen/Watt Medium Power	Lumen/Watt High Power	Q mm	Lumen/Watt Medium Power	Lumen/Watt High Power	Q mm	Lumen/Watt Medium Power	Lumen/Watt High Power
300	1970lm/16W	2850lm/24W	300	1210lm/11W	1740lm/16W	300	1930lm/16W	2760lm/24W	300	1170lm/11W	1650lm/16W
400	2920lm/23W	4170lm/32W	400	1960lm/16W	2860lm/24W	400	2870lm/23W	4120lm/32W	400	1910lm/16W	2810lm/24W
500	4580lm/33W	5900lm/44W	500	3330lm/26W	4290lm/34W	500	4550lm/33W	5880lm/44W	500	3300lm/26W	4270lm/34W
600	7240lm/55W	9850lm/76W	600	5250lm/40W	7100lm/55W	600	7170lm/55W	9750lm/76W	600	5180lm/40W	7000lm/55W
800	10590lm/76W	14950lm/109W	800	7590lm/55W	10630lm/78W	800	10370lm/76W	14440lm/109W	800	7370lm/55W	10120lm/78W

Lumen Values: Luminarie luminous flux at 4000K/CRI>80. Other configurations on request.

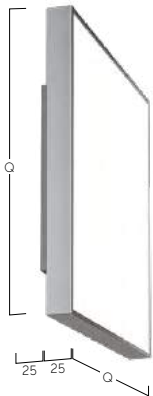

Emergency Module



W Snow White



E Silver Anodised

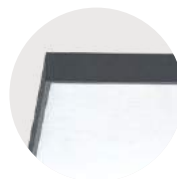

U Urban Graphite



B Jet Black



H Anodic Champagne

Cubic Déco A3 | Wall



DE LED-Anbauleuchte für Wand- und Deckenmontage. Direktstrahlend. Leuchtenkörper aus Aluminiumprofil. Rückversetzte Optik für bessere Blendungsbegrenzung und dekorative Lichtwirkung. Gehäuse-Außenfläche und rundum laufender Reflektorring in unterschiedlichen Lackierungen und Kombinationen erhältlich, z.B. weiß, silber, graphit, schwarz, gold oder kupferfarben. Zu Oberflächenoptionen- und Kombinationen siehe Lightnet-Surface-Collection oder Bi-Colour-Auswahl. Microprismenoptik aus Acrylglas mit optimierter Blendungsbegrenzung speziell für Office-Anwendungen. Satinierter Opaldiffusor für Allgemeinbeleuchtung mit max. Transmissionsgrad und homogener Lichtpunktauflösung. Konverter in Leuchtgehäuse integriert, wahlweise einfachschaltbar oder stufenlos dimmbar (DALI, Touch-Dim, Casambi). Farbtemperatur 2200K, 2700K, 3000K, 3500K, 4000K, 6500K oder Tunable White (2700-6500K). Binning initial \leq MacAdam 3. Farbwiedergabe CRI $>$ 80, CRI $>$ 90 oder Full Spectrum. Auf Anfrage: Integration von Notlichtkomponenten.

EN LED surface-mounted luminaire for walls and ceilings. Direct only light distribution. Luminaire body made of aluminum profile. Recessed screen with optimized glare reduction and decorative lighting impact. Outer housing and all-round reflector ring available in various finishes and combinations, e.g. white, silver, graphite, black, gold or copper coated. Further surface options see Lightnet-Surface-Collection or RAL of your choice. Microprismatic screen made of special acrylic glass with optimized glare reduction especially for workplaces. Satin opal diffuser for general lighting with maximum transmittance and homogeneous lighting. Driver integrated into luminaire housing, optionally switchable or dimmable (DALI, Touch-Dim, Casambi). Colour temperature 2200K, 2700K, 3000K, 3500K, 4000K, 6500K or Tunable White (2700-6500K). Binning \leq MacAdam 3. Colour rendering CRI $>$ 80, CRI $>$ 90 or Full Spectrum. On request: Integration of emergency lighting components.

C A3 A B E - 8 30 M - Q330-G

- Product Family **C:** Cubic
- Type **A3:** Direct Only
- Optical System **A:** Microprismatic, **O:** Opal Diffuser
- Surface Finish **W:** Snow White, **V:** Ivory White, **S:** Radiant Silver, **U:** Urban Graphite, **B:** Jet Black, **H:** Anodic Champagne, **K:** Satin Copper
- Control Gear **E:** On/Off, **L:** DALI, **H:** Touch-Dim, **C:** Casambi, **6:** DALI DT6 for TW, **8:** DALI DT8 for TW
- Colour Rendering **8:** CRI>80, **9:** CRI>90, **F:** Full Spectrum [except 2200K]
- Colour Temperature **22:** 2200K, **27:** 2700K, **30:** 3000K, **35:** 3500K, **40:** 4000K, **65:** 6500K, **TW:** Tunable White 2700-6500K [Q430-Q1200]
- Power **M:** Medium Power, **H:** High Power
- Size Square Size in mm: **Q330, Q430, Q530, Q630, Q900, Q1200**
- Reflector **W:** Snow White, **V:** Ivory White, **S:** Radiant Silver, **U:** Urban Graphite, **B:** Jet Black, **H:** Anodic Champagne, **K:** Satin Copper, **G:** Satin Gold
- On Request Emergency Module [Q430-Q1200]



Microprismatic | Direct

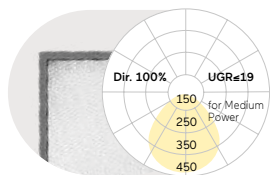

Opal Diffuser | Direct

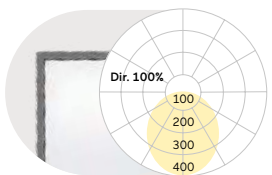

Q mm	Lumen/Watt Medium Power	Lumen/Watt High Power	Q mm	Lumen/Watt Medium Power	Lumen/Watt High Power
330	1360lm/12W	2010lm/18W	330	1400lm/12W	2070lm/18W
430	2370lm/19W	3450lm/27W	430	2440lm/19W	3550lm/27W
530	3630lm/27W	6790lm/50W	530	3740lm/27W	6990lm/50W
630	5200lm/40W	8500lm/65W	630	5360lm/40W	8760lm/65W
900	7910lm/67W	13240lm/129W	900	8150lm/67W	13640lm/129W
1200	14100lm/122W	23550lm/228W	1200	14520lm/122W	24260lm/228W

Lumen Values: Luminaire luminous flux at 4000K/CRI>80. Other configurations on request.



Cubic Ambient A7 | Wall



DE LED- Anbauleuchte. Direkt-rundumstrahlend für dezente Deckenaufhellung. Leuchtenkörper aus Aluminium. Oberfläche weiß, silber, graphit, schwarz bzw. champagnerfarben lackiert. Weitere Oberflächenoptionen siehe Lightnet-Surface-Collection oder RAL nach Wahl. Ambientdiffusor aus satiniertem Acrylglas für Allgemeinbeleuchtung. Konverter in Leuchtengehäuse integriert, wahlweise einfach schaltbar oder stufenlos dimmbar (DALI, Touch-Dim, Casambi). Farbtemperatur 2700K, 3000K, 3500K 4000K oder 6500K. Binning initial \leq MacAdam 3. Farbwiedergabe CRI $>$ 80, CRI $>$ 90 oder Full Spectrum. Auf Anfrage: Integration von Notlichtkomponenten, Sensortechnologie.

EN LED surface-mounted luminaire. Omnidirectional light distribution for discreet illumination of the ceiling. Luminaire body made of aluminium. Surface white, silver, graphite, black or champagne coated. Further surface options see Lightnet-Surface-Collection or RAL of your choice. Ambient diffuser made of frosted acrylic glass for general lighting. Driver integrated into luminaire housing, optionally switchable or dimmable (DALI, Touch-Dim, Casambi). Colour temperature 2700K, 3000K, 3500K, 4000K or 6500K. Binning \leq MacAdam 3. Colour rendering CRI $>$ 80, CRI $>$ 90 or Full Spectrum. On request: Integration of emergency lighting components, sensor technology.

C A7 F B E - 8 30 M - Q300

- Product Family **C:** Cubic
- Type **A7:** Direct Only
- Optical System **F:** Ambient
- Surface Finish **W:** Snow White, **S:** Radiant Silver, **U:** Urban Graphite, **B:** Jet Black, **H:** Anodic Champagne
- Control Gear **E:** On/Off, **L:** DALI, **H:** Touch-Dim, **C:** Casambi
- Colour Rendering **8:** CRI>80, **9:** CRI>90, **F:** Full Spectrum [except 2200K]
- Colour Temperature **22:** 2200K, **27:** 2700K, **30:** 3000K, **35:** 3500K, **40:** 4000K, **65:** 6500K
- Power **M:** Medium Power, **H:** High Power
- Size Square Size in mm: **Q300, Q400, Q500, Q600**
- On Request Emergency Module [Q400-Q600]



Ambient Diffuser | Direct

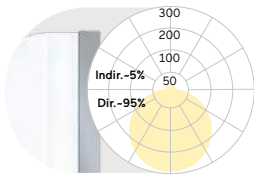

Q mm	Lumen/Watt Medium Power	Lumen/Watt High Power
300	1480lm/12W	2150lm/15W
400	2950lm/21W	3880lm/27W
500	4410lm/30W	6520lm/43W
600	5650lm/38W	8540lm/58W

Lumen Values: Luminarie luminous flux at 4000K/CRI>80. Other configurations on request.

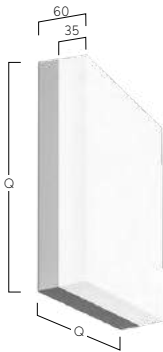

W Snow White



S Radiant Silver



U Urban Graphite

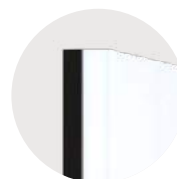

B Jet Black



H Anodic Champagne

Matric Wall



Kindergarten, Grünenplan, Germany
Matric A1
Photography: Frank Aussieker



Residential Park Lahe, Germany
Matric A1
Photography: Frank Aussieker



Architectural Group Bircher Roth von Arx AG
Aarau, Switzerland
Matric W5
Realization and photography: Mabalux AG

Matric Ambient AX | System 40mm Wall



DE LED-Anbauleuchte für wahlweise horizontale oder vertikale Wandmontage oder Deckenmontage. Direkt-rundumstrahlend für dezente Wand-/Deckenaufhellung. Lichtkanal aus Aluminiumprofil. Millimetergenaue Längenfertigung nach Vorgabe möglich. Oberfläche natureloxiert oder weiß, graphit, schwarz, champagner oder kupferfarben lackiert. Weitere Oberflächenoptionen siehe Lightnet-Surface-Collection oder RAL nach Wahl. Ambientdiffusor aus satiniertem Acrylglas für Allgemeinbeleuchtung. Konverter in Leuchtengehäuse integriert, wahlweise einfach schaltbar oder stufenlos dimmbar (DALI, Touch-Dim, Casambi). Farbtemperatur 2200K, 2700K, 3000K, 3500K, 4000K, 6500K oder Tunable White (2700-6500K). Binning initial \leq MacAdam 3. Farbwiedergabe CRI>80, CRI>90 oder Full Spectrum. Auf Anfrage: Integration von Notlichtkomponenten.

EN LED surface-mounted luminaire for optional horizontal or vertical wall mounting or ceiling mounting. Omnidirectional light distribution for soft wall or ceiling illumination. Light channel made of aluminium profile. Bespoke lengths possible. Surface natural anodised or white, graphite, black, champagne or copper coated. Further surface options see Lightnet-Surface-Collection or RAL of your choice. Ambient diffuser made of frosted acrylic glass for general lighting. Driver integrated into luminaire housing, optionally switchable or dimmable (DALI, Touch-Dim, Casambi). Colour temperature 2200K, 2700K, 3000K, 3500K, 4000K, 6500K or Tunable White (2700-6500K). Binning \leq MacAdam 3. Colour rendering CRI>80, CRI>90 or Full Spectrum. On request: Integration of emergency lighting components.

LAXFWE - 8 30 M - L1182

- Product Family **L:** Matric
- Type **AX:** Direct only
- Optical System **F:** Ambient
- Surface Finish **W:** Snow White, **V:** Ivory White, **E:** Silver Anodised, **U:** Urban Graphite, **B:** Jet Black, **H:** Anodic Champagne, **K:** Satin Copper
- Control Gear **E:** On/Off, **L:** DALI, **H:** Touch-Dim, **C:** Casambi [L890-L2055], **6:** DALI DT6 for TW [L1182-L2055], **8:** DALI DT8 for TW [L890-L2055]
- Colour Rendering **8:** CRI>80, **9:** CRI>90, **F:** Full Spectrum [except 2200K]
- Colour Temperature **22:** 2200K, **27:** 2700K, **30:** 3000K, **35:** 3500K, **40:** 4000K, **65:** 6500K, **TW:** Tunable White 2700-6500K
- Power **M:** Medium Power, **H:** High Power
- Size Luminaire Length in mm: **L600, L890, L1182, L1475, L1765, L2055**
- On Request Emergency Module [L1182-L2055]



Ambient | Direct

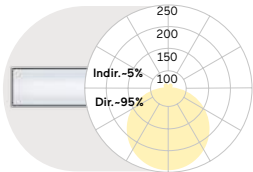

L mm	Lumen/Watt Medium Power	Lumen/Watt High Power
600	1080lm/9W	1460lm/12W
890	1620lm/12W	2190lm/16W
1182	2150lm/16W	2910lm/21W
1475	2690lm/19W	3640lm/26W
1765	3230lm/22W	4370lm/30W
2055	3770lm/28W	5100lm/37W

Lumen Values: Luminaire luminous flux at 4000K/CRI>80. Other configurations on request.

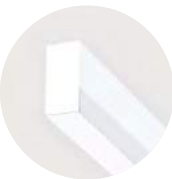
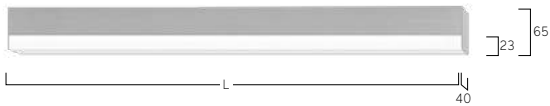

W Snow White

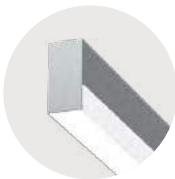

E Silver Anodized

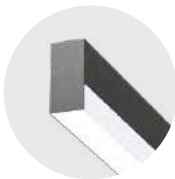

U Urban Graphite



B Jet Black

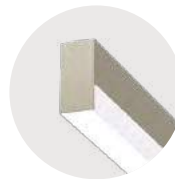

H Anodic Champagne



K Satin Copper

Matric WX | System 40mm Wall



DE LED-Anbauleuchte für wahlweise horizontale oder vertikale Wandmontage (Deckenmontage ebenfalls möglich). Direkt-indirektstrahlend. Lichtkanal aus Aluminiumprofil. Millimetergenaue Längenfertigung nach Vorgabe möglich. Oberfläche natureloxiiert oder weiß, graphit, schwarz, champagner oder kupferfarben lackiert. Weitere Oberflächenoptionen siehe Lightnet-Surface-Collection oder RAL nach Wahl. Microprismenoptik mit optimierter Blendungsbegrenzung speziell für Office-Anwendungen. Opaldiffusor aus satiniertem Acrylglas für Allgemeinbeleuchtung. Asymmetrische Optik für homogene Beleuchtung in die Raumtiefe hinein. Konverter in Leuchtengehäuse integriert, wahlweise einfach schaltbar oder stufenlos dimmbar (DALI, Touch-Dim, Casambi). Farbtemperatur 2200K, 2700K, 3000K, 3500K, 4000K, 6500K oder Tunable White (2700-6500K). Binning initial \leq MacAdam 3. Farbwiedergabe CRI>80, CRI>90 oder Full Spectrum. Auf Anfrage: Integration von 48V-Stromschienen für Midpin, Notlichtkomponenten.

EN LED surface-mounted luminaire for optional horizontal or vertical wall mounting (ceiling mounting also possible). Direct-indirect light distribution. Light channel made of aluminium profile. Bespoke lengths possible. Surface natural anodised or white, graphite, black, champagne or copper coated. Further surface options see Lightnet-Surface-Collection or RAL of your choice. Microprismatic screen with optimized glare reduction especially for workplaces. Opal diffuser made of acrylic glass for general lighting. Asymmetrical optics for homogeneous illumination extending into the depth of the room. Driver integrated into luminaire housing, optionally switchable or dimmable (DALI, Touch-Dim, Casambi). Colour temperature 2200K, 2700K, 3000K, 3500K, 4000K, 6500K or Tunable White (2700-6500K). Binning \leq MacAdam 3. Colour rendering CRI>80, CRI>90 or Full Spectrum. On request: Integration of 48V tracks for Midpin, emergency lighting components.

LWXOWE - 830 M - L1185

- Product Family **L:** Matric
- Type **WX:** Direct-Indirect
- Optical System **A:** Microprismatic, **O:** Opal Diffuser, **G:** Asymmetrical
- Surface Finish **W:** Snow White, **V:** Ivory White, **E:** Silver Anodised, **U:** Urban Graphite, **B:** Jet Black, **H:** Anodic Champagne, **K:** Satin Copper
- Control Gear **E:** On/Off, **L:** DALI, **H:** Touch-Dim, **C:** Casambi [L895-L2060], **6:** DALI DT6 for TW [L1185-L2060], **8:** DALI DT8 for TW [L895-L2060]
- Colour Rendering **8:** CRI>80, **9:** CRI>90, **F:** Full Spectrum [except 2200K]
- Colour Temperature **22:** 2200K, **27:** 2700K, **30:** 3000K, **35:** 3500K, **40:** 4000K, **65:** 6500K, **TW:** Tunable White 2700-6500K
- Power **E:** Low Power, **M:** Medium Power, **H:** High Power
- Size Luminaire Length in mm: **L600, L895, L1185, L1478, L1770, L2060**
- On Request 90°Corner, Laser Cut-Out, Midpin Spotlight XM, 3-Phase Track, 48V-Track, Multisensor [L1182-L2060], Emergency Module [L1185-L2060]



Microprismatic Direct-Indirect			Opal Diffuser Direct-Indirect			Asymmetrical Direct-Indirect		
L mm	Lumen/Watt Low Power	Lumen/Watt High Power	L mm	Lumen/Watt Medium Power	Lumen/Watt High Power	L mm	Lumen/Watt Low Power	Lumen/Watt High Power
600	1730lm/17W	2650lm/26W	600	2240lm/21W	2820lm/26W	600	1140lm/14W	2200lm/27W
895	2600lm/24W	3970lm/38W	895	3360lm/30W	4230lm/38W	895	1720lm/20W	3300lm/39W
1185	3470lm/32W	5300lm/51W	1185	4470lm/40W	5630lm/51W	1185	2290lm/26W	4400lm/53W
1478	4340lm/40W	6620lm/62W	1478	5590lm/49W	7040lm/62W	1478	2860lm/32W	5500lm/65W
1770	5200lm/48W	7940lm/73W	1770	6710lm/57W	8450lm/73W	1770	3430lm/38W	6600lm/76W
2060	6070lm/57W	9270lm/90W	2060	7830lm/70W	9860lm/90W	2060	4000lm/46W	7700lm/93W

Lumen Values: Luminaire luminous flux at 4000K/CRI>80. Other configurations on request.

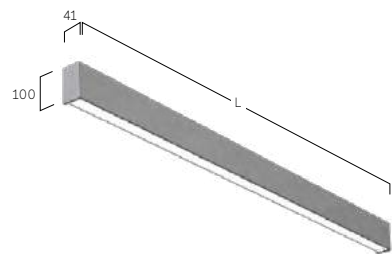

Integration of Midpin Spotlights



Matric DX | System 40 mm Wall

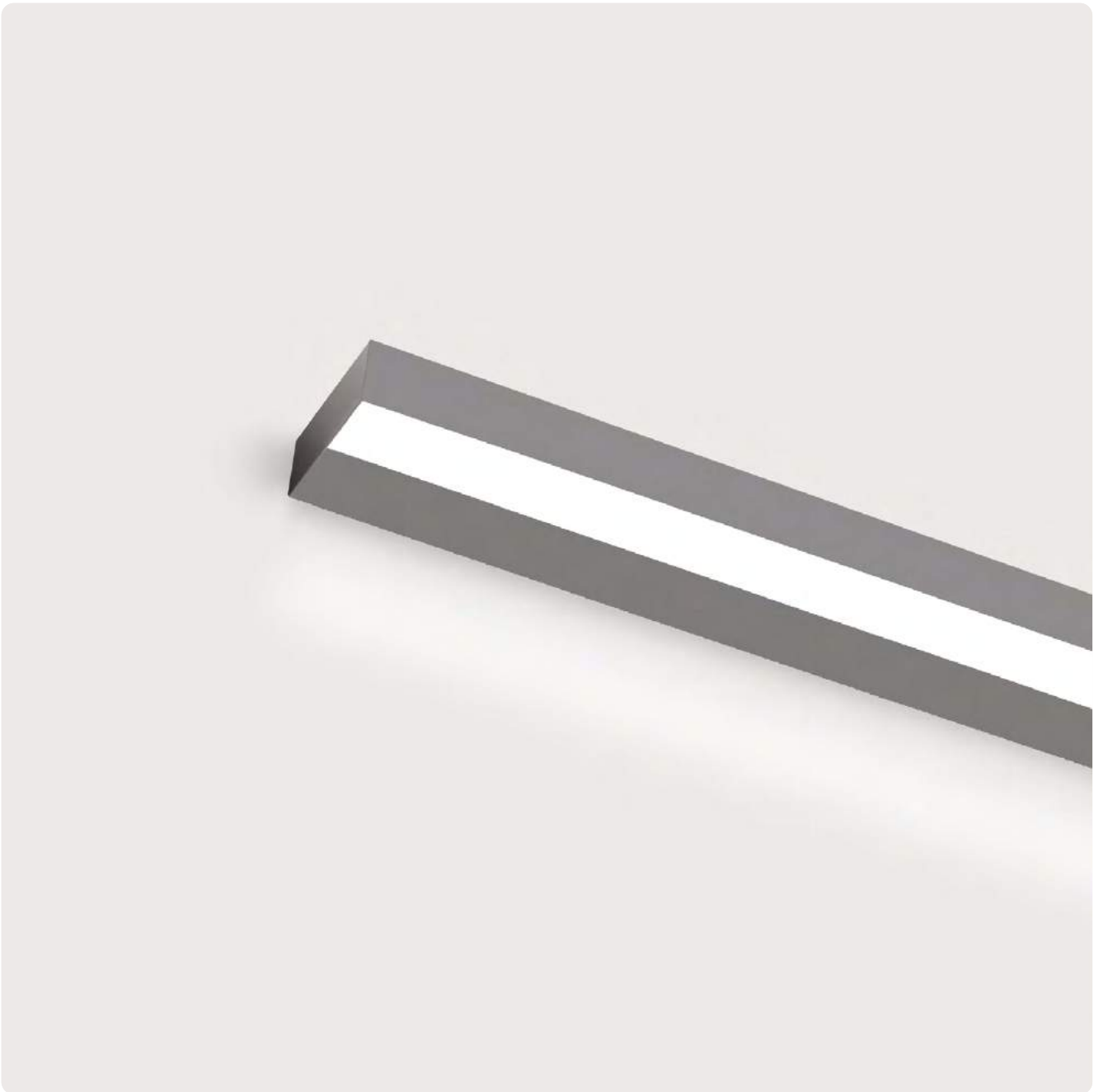

DE LED-Anbauleuchte für horizontale Wandmontage (Deckenmontage auf Anfrage möglich). Direktstrahlend. Lichtkanal aus Aluminiumprofil. Millimetergenaue Längenfertigung nach Vorgabe möglich. Oberfläche natureloxiiert oder weiß, graphit, schwarz, champagner oder kupferfarben lackiert. Weitere Oberflächenoptionen siehe Lightnet-Surface-Collection oder RAL nach Wahl. Microprismenoptik mit optimierter Blendungsbegrenzung speziell für Office-Anwendungen. Satinierter Opaldiffusor für Allgemeinbeleuchtung. Konverter in Leuchtgehäuse integriert, wahlweise einfach schaltbar oder stufenlos dimmbar (DALI, Touch-Dim, Casambi). Farbtemperatur 2200K, 2700K, 3000K, 3500K, 4000K, 6500K oder Tunable White (2700-6500K). Binning initial \leq MacAdam 3. Farbwiedergabe $\text{CRI} > 80$, $\text{CRI} > 90$ oder Full Spectrum. Auf Anfrage: Integration von Notlichtkomponenten.

EN LED surface-mounted luminaire for horizontal wall mounting (ceiling mounting possible on request). Direct only light distribution. Light channel made of aluminium profile. Bespoke lengths possible. Surface natural anodised or white, graphite, black, champagne or copper coated. Further surface options see Lightnet-Surface-Collection or RAL of your choice. Microprismatic screen with optimized glare reduction especially for workplaces. Satin opal diffuser for general lighting. Driver integrated into luminaire housing, optionally switchable or dimmable (DALI, Touch-Dim, Casambi). Colour temperature 2200K, 2700K, 3000K, 3500K, 4000K, 6500K or Tunable White (2700-6500K). Binning \leq MacAdam 3. Colour rendering $\text{CRI} > 80$, $\text{CRI} > 90$ or Full Spectrum. On request: Integration of emergency lighting components.

L DX O U L - 8 30 M - L890

Product Family	L: Matric
Type	DX: Direct only
Optical System	A: Microprismatic, O: Opal Diffuser
Surface Finish	W: Snow White, E: Silver Anodised, U: Urban Graphite, B: Jet Black, H: Anodic Champagne, K: Satin Copper
Control Gear	E: On/Off, L: DALI, H: Touch-Dim, C: Casambi
Colour Rendering	8: CRI>80, 9: CRI>90, F: Full Spectrum [except 2200K]
Colour Temperature	22: 2200K, 27: 2700K, 30: 3000K, 35: 3500K, 40: 4000K, 65: 6500K
Power	M: Medium Power, H: High Power
Size	Luminaire Length in mm: L890, L1182, L1475, L1765, L2055
On Request	Emergency Module [L1475-L2055]

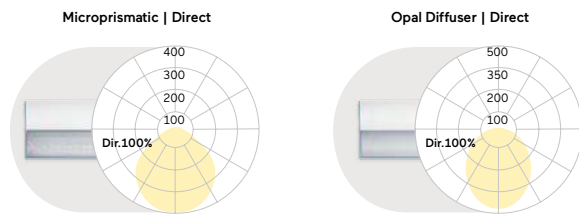

L mm	Lumen/Watt		L mm	Lumen/Watt	
	Medium Power	High Power		Medium Power	High Power
890	1230lm/21W	1780lm/31W	890	1450lm/21W	2080lm/31W
1182	1640lm/27W	2370lm/41W	1182	1930lm/27W	2770lm/41W
1475	2050lm/33W	2960lm/51W	1475	2410lm/33W	3460lm/51W
1765	2460lm/39W	3560lm/60W	1765	2900lm/39W	4160lm/60W
2055	2870lm/48W	4150lm/72W	2055	3380lm/48W	4850lm/72W

Lumen Values: Luminaire luminous flux at 4000K/CRI>80. Other configurations on request.

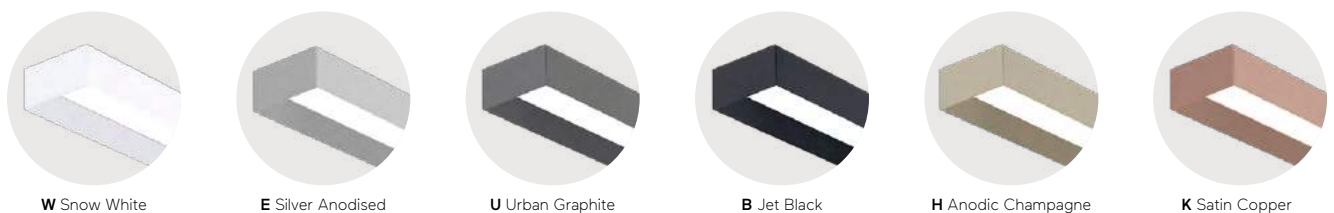
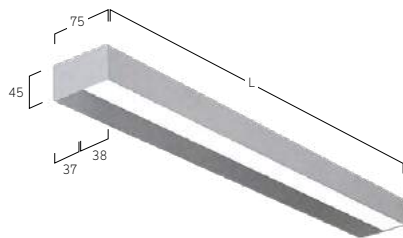

Matric JX | System 40 mm Wall



DE LED-Anbauleuchte für horizontale Wandmontage. Rein indirektstrahlend. Lichtkanal aus Aluminiumprofil. Millimetergenaue Längenfertigung nach Vorgabe möglich. Oberflächenanodisiert oder weiß, graphit, schwarz, champagner oder kupferfarben lackiert. Weitere Oberflächenoptionen siehe Lightnet-Surface-Collection oder RAL nach Wahl. Hochwertige Microprismenoptik für indirekten Sicht- und Staubschutz sowie gerichtete Wand-/ Deckenverteilung des Lichts. Konverter in Leuchtgehäuse integriert, wahlweise einfach schaltbar oder stufenlos dimmbar (DALI, Touch-Dim, Casambi). Farbtemperatur 2200K, 2700K, 3000K, 3500K, 4000K, 6500K oder Tunable White (2700-6500K). Binning initial \leq MacAdam 3. Farb wiedergabe CRI > 80, CRI > 90 oder Full Spectrum.

EN LED surface-mounted luminaire for horizontal wall mounting. Indirect only light distribution. Light channel made of aluminium profile. Bespoke lengths possible. Surface natural anodised or white, graphite, black, champagne or copper coated. Further surface options see Lightnet-Surface-Collection or RAL of your choice. High-quality microprismatic screen for indirect visual and dust protection as well as directional wall/ceiling light distribution. Driver integrated into luminaire housing, optionally switchable or dimmable (DALI, Touch-Dim, Casambi). Colour temperature 2200K, 2700K, 3000K, 3500K, 4000K, 6500K or Tunable White (2700-6500K). Binning \leq MacAdam 3. Colour rendering CRI > 80, CRI > 90 or Full Spectrum.

L J X A U L - 8 3 0 M - L 8 9 0

- Product Family **L:** Matric
- Type **JX:** Indirect only
- Optical System **A:** Microprismatic
- Surface Finish **W:** Snow White, **E:** Silver Anodised, **U:** Urban Graphite, **B:** Jet Black, **H:** Anodic Champagne, **K:** Satin Copper
- Control Gear **E:** On/Off, **L:** DALI, **H:** Touch-Dim, **C:** Casambi
- Colour Rendering **8:** CRI>80, **9:** CRI>90, **F:** Full Spectrum [except 2200K]
- Colour Temperature **22:** 2200K, **27:** 2700K, **30:** 3000K, **35:** 3500K, **40:** 4000K, **65:** 6500K
- Power **M:** Medium Power, **H:** High Power
- Size Luminaire Length in mm: **L890, L1182, L1475, L1765, L2055**
- On Request Emergency Module [L1475-L2055]



Microprismatic | Indirect

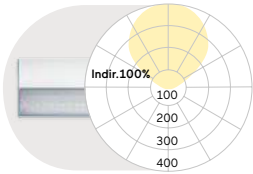

L mm	Lumen/Watt Medium Power	Lumen/Watt High Power
890	1230lm/21W	1780lm/31W
1182	1640lm/27W	2370lm/41W
1475	2050lm/33W	2960lm/51W
1765	2460lm/39W	3560lm/60W
2055	2870lm/48W	4150lm/72W

Lumen Values: Luminaire luminous flux at 4000K/CRI>80. Other configurations on request.

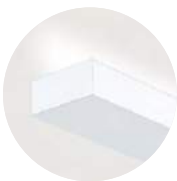
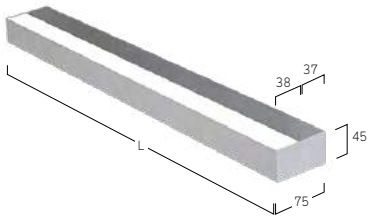

W Snow White



E Silver Anodised



U Urban Graphite

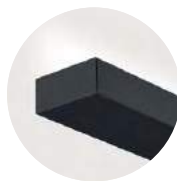

B Jet Black



H Anodic Champagne



K Satin Copper

Matric W4 | System 55 mm Wall



DE LED-Anbauleuchte für horizontale Wandmontage. Direkt-indirektstrahlend. Lichtkanal aus Aluminiumprofil. Millimetergenaue Längenfertigung nach Vorgabe möglich. Oberfläche natureloxiert oder weiß, graphit, schwarz, champagner oder kupferfarben lackiert. Weitere Oberflächenoptionen siehe Lightnet-Surface-Collection oder RAL nach Wahl. Microprismenoptik mit optimierter Blendungsbegrenzung speziell für Office-Anwendungen. Satiniertes Opaldiffusor für Allgemeinbeleuchtung. Asymmetrische Optik für homogene Beleuchtung in die Raumtiefe hinein. Konverter in Leuchtgehäuse integriert, Lichtkammern für direktes und indirektes Licht getrennt schaltbar oder dimmbar (DALI, Casambi). Farbtemperatur 2200K, 2700K, 3000K, 3500K, 4000K, 6500K oder Tunable White (2700-6500K). Binning initial \leq MacAdam 3. Farbwiedergabe CRI $>$ 80 oder CRI $>$ 90 oder Full Spectrum. Auf Anfrage: Integration 48V Stromschienen oder 3-Phasenstromschienen, Notlichtkomponenten.

EN LED surface-mounted luminaire for horizontal wall mounting. Direct-indirect light distribution. Light channel made of aluminium profile. Bespoke lengths possible. Surface natural anodised or white, graphite, black, champagne or copper coated. Further surface options see Lightnet-Surface-Collection or RAL of your choice. Microprismatic screen with optimized glare reduction especially for workplaces. Satin opal diffuser for general lighting. Asymmetrical optics for homogeneous illumination extending into the depth of the room. Driver integrated into luminaire housing, light chambers for direct and indirect light separately switchable or dimmable (DALI, Casambi). Colour temperature 2200K, 2700K, 3000K, 3500K, 4000K, 6500K or Tunable White (2700-6500K). Binning \leq MacAdam 3. Colour rendering CRI $>$ 80, CRI $>$ 90 or Full Spectrum. On request: Integration of 48V tracks or 3-phase tracks, emergency lighting components.

LW4 OEU - 830 M - L1182

Product Family	L: Matric
Type	W4: Direct-Indirect
Optical System	A: Microprismatic, O: Opal Diffuser, G: Asymmetrical, D: Opal Diffuser (Polycarbonate)**
Surface Finish	W: Snow White, E: Silver Anodized, U: Urban Graphite, B: Jet Black, H: Anodic Champagne, K: Satin Copper
Control Gear	G: Separately Switchable, U: Separately Dimmable DALI, 6: DALI DT6 for TW [L1475-L2055], 8: DALI DT8 for TW
Colour Rendering	8: CRI>80, 9: CRI>90, F: Full Spectrum [except 2200K]
Colour Temperature	22: 2200K, 27: 2700K, 30: 3000K, 35: 3500K, 40: 4000K, 65: 6500K, TW: Tunable White 2700-6500K
Power	E: Low Power, M: Medium Power, H: High Power
Size	Luminaire Length in mm: L890, L1182, L1475, L1765, L2055
On Request	Special Length Versions, 90°-Corner, Midpin Downlight, XD, Midpin Spotlight XM, 3-Phase Track, Multisensor [L1182-L2055], Emergency Module [L1182-L2055]

**Opal Diffuser made of sustainable TruCircle Polycarbonate / Fire Rated - Glow wire flammability Index 950°C EN60695-2-12 / Tp(a). Luminous flux reduction of 10%



Microprismatic | Direct-Indirect

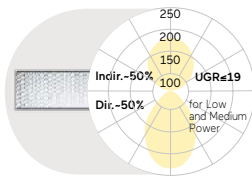

Opal Diffuser | Direct-Indirect

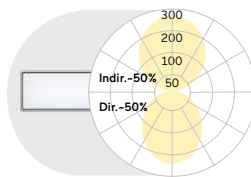

Asymmetrical | Direct-Indirect

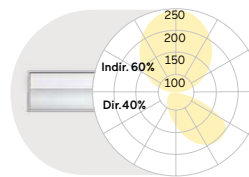

L mm	Lumen/Watt			L mm	Lumen/Watt			L mm	Lumen/Watt	
	Low Power	Medium Power	High Power		Low Power	Medium Power	High Power		Medium Power	High Power
890	2370lm/22W	3260lm/30W	4540lm/42W	890	2490lm/22W	3420lm/30W	4770lm/42W	890	2730lm/26W	3730lm/37W
1182	3200lm/28W	4410lm/39W	6140lm/55W	1182	3350lm/28W	4630lm/39W	6450lm/55W	1182	3700lm/37W	5070lm/51W
1475	4040lm/35W	5560lm/48W	7750lm/68W	1475	4230lm/35W	5820lm/48W	8130lm/68W	1475	4670lm/45W	6400lm/63W
1765	4870lm/41W	6710lm/56W	9350lm/81W	1765	5110lm/41W	7030lm/56W	9810lm/81W	1765	5640lm/54W	7740lm/75W
2055	5700lm/50W	7860lm/69W	10960lm/98W	2055	5980lm/50W	8240lm/69W	11490lm/98W	2055	6620lm/65W	9070lm/91W

Lumen Values: Luminaire luminous flux at 4000K/CRI>80. Other configurations on request.

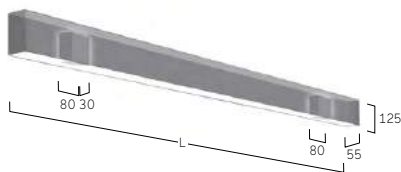

90° Corner
Opal/Microprismatic



Midpin-Downlight XD
770lm/10W/Ø40mm



Midpin-Spotlight XM
770lm/10W/Ø40mm



3-Phase Track

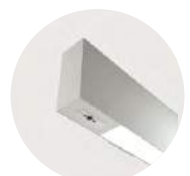

Multisensor



W Snow White



E Silver Anodized

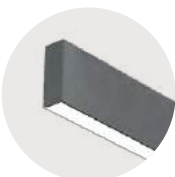

U Urban Graphite



B Jet Black

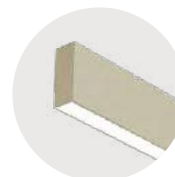

H Anodic Champagne



K Satin Copper

Matric W6 | System 81mm Wall



DE LED-Anbauleuchte für horizontale Wandmontage. Gehäuse aus Aluminiumprofil. Oberfläche natureloxiert oder weiß, graphit, schwarz, champagner oder kupferfarben lackiert. Weitere Oberflächenoptionen siehe Lightnet-Surface-Collection oder RAL nach Wahl. Microprismenoptik mit optimierter Blendungsbegrenzung speziell für Office-Anwendungen. Satinierter Opaldiffusor für Allgemeinbeleuchtung. Indirektanteil mit klarer Acrylglasabdeckung für Staubschutz. Konverter in Leuchtgehäuse integriert, wahlweise einfach schaltbar oder stufenlos dimmbar (DALI, Touch-Dim, Casambi). Farbtemperatur 2200K, 2700K, 3000K, 3500K, 4000K, 6500K oder Tunable White (2700-6500K). Binning initial \leq Mac Adam 3. Farbwiedergabe CRI $>$ 80, CRI $>$ 90 oder Full Spectrum.

EN LED surface-mounted luminaire for horizontal wall mounting. Housing made of aluminium profile. Surface natural anodised or white, graphite, black, champagne or copper coated. Further surface options see Lightnet-Surface-Collection or RAL of your choice. Microprismatic screen with optimized glare reduction especially for workplaces. Satin opal diffuser for general lighting. Indirect component with clear acrylic cover for dust protection. Driver integrated into luminaire housing, optionally switchable or dimmable (DALI, Touch-Dim, Casambi). Colour temperature 2200K, 2700K, 3000K, 3500K, 4000K, 6500K or Tunable White (2700-6500K). Binning \leq MacAdam 3. Colour rendering CRI $>$ 80, CRI $>$ 90 or Full Spectrum.

LW6OEE - 830M - L1182

Product Family **L:** Matric

Type **W6:** Direct-Indirect

Optical System **A:** Microprismatic, **O:** Opal Diffuser, **J:** Wallwasher

Surface Finish **W:** Snow White, **E:** Silver Anodised, **U:** Urban Graphite, **B:** Jet Black, **H:** Anodic Champagne, **K:** Satin Copper

Control Gear **E:** On/Off, **L:** DALI, **H:** Touch-Dim, **8:** DALI DT8 for TW

Colour Rendering **8:** CRI>80, **9:** CRI>90, **F:** Full Spectrum [except 2200K]

Colour Temperature **22:** 2200K, **27:** 2700K, **30:** 3000K, **35:** 3500K, **40:** 4000K, **65:** 6500K, **TW:** Tunable White 2700-6500K

Power **M:** Medium Power, **H:** High Power

Size Luminaire Length in mm: **L890, L1182, L1475**



Microprismatic | Direct-Indirect

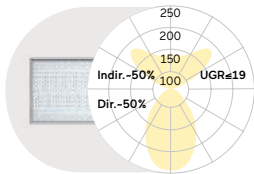

Opal Diffuser | Direct-Indirect

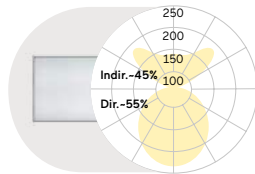

Wallwasher | Direct-Indirect

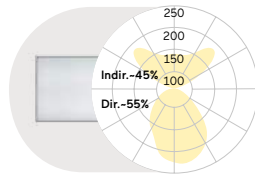

L mm	Lumen/Watt Medium Power	Lumen/Watt High Power
890	4080lm/34W	5520lm/46W
1182	5440lm/44W	7370lm/61W
1475	6800lm/54W	9210lm/74W

L mm	Lumen/Watt Medium Power	Lumen/Watt High Power
890	4530lm/34W	6140lm/46W
1182	6050lm/44W	8190lm/61W
1475	7560lm/54W	10230lm/74W

L mm	Lumen/Watt Medium Power	Lumen/Watt High Power
890	4180lm/34W	5660lm/46W
1182	5570lm/44W	7550lm/61W
1475	6970lm/54W	9430lm/74W

Lumen Values: Luminaire luminous flux at 4000K/CRI>80. Other configurations on request.

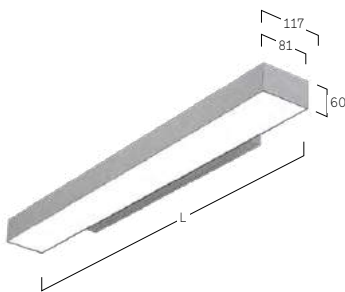

W Snow White



E Silver Anodized



U Urban Graphite

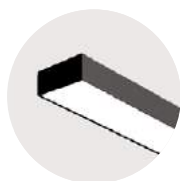

B Jet Black



H Anodic Champagne



K Satin Copper



Midpin G3 |
Single Suspended
174



Midpoint P7/P8 |
Suspended
176



Basic Superflat G7/P7 |
Suspended
180



Basic Neo G5/P5 |
Suspended
184



Basic Déco G3/P3 |
Suspended
188



Basic Déco XXL G4/P4 |
Suspended
190



Basic Déco O3 |
Suspended
192



Basic Max G1/P1 |
Suspended
196



Basic Visio G9/P9 |
Suspended
198



Beam Me Up (Flat)
G3/P3 | Suspended
202



Beam Me Up (Max)
G1/P1 | Suspended
206



Ringo Star Compact
G5/P5 | Suspended
208



Ringo Star GY/PY |
System 40mm Suspended
210



Ringo Star GX/PX |
System 40mm Suspended
212



Ringo Star Acoustic GY/PY |
System 40mm Suspended
214



Ringo Star G3/P3 |
System 60mm Suspended
222



Ringo Star Acoustic G3/P3 |
System 60mm Suspended
224



Ringo Star G1/P1 |
System 100mm Suspended
226



Ringo Star Acoustic G1/P1 |
System 100mm Suspended
228



Ringo Star Chandelier
G1/P1 | Suspended
232



Ringo Star Cluster G3/P3 |
Suspended
240



Ringo Star Chain G3/P3 |
Suspended
242



Ringo Star Oblong
GX/PX | Suspended
244



Liquid Line Compact
G5/P5 | Suspended
246



Liquid Line GX/PX |
System 40mm Suspended
248



Liquid Line G3/P3 |
System 60mm Suspended
264



Code Zero G3/P3 |
Suspended
272



Caleo Inverse GX/PX |
System 40mm Suspended
274



Caleo Neo G4/P4 |
Suspended
276



Caleo Neo G6/P6 |
Suspended
280



Cubic Evolution G4/P4 |
200mm Suspended
284



Cubic Evolution G5/P5 |
300mm Suspended
286



Cubic Evolution G6/P6 |
Square Suspended
288



Cubic Evolution G4/P4 |
System Suspended
290



Cubic Evolution U4 |
Suspended
292



Cubic Max G2/P2 |
Suspended
294



Cubic Ambient G7/P7 |
Suspended
296



Cubic Déco G3/P3 |
Suspended
298



Matric Déco G9/R9 |
Suspended
300



Matric RY | System 40mm
Suspended
308

Pendel | Suspended



Matric GX/RX | System
40mm Suspended
310



Matric G3/R3 | System
55mm Suspended
312



Matric R4 | System
55mm Suspended
314



Matric G5 | System
81mm Suspended
316



Matric G6/R6 | System
81mm Suspended
318



Matric Square GX/RX |
System 40mm Suspended
322



Matric Square Acoustic GX/RX |
System 40mm Suspended
326

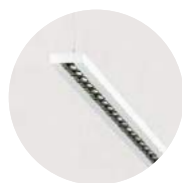

Vision Gen. 4 G4/P4 |
Suspended
328



Plank G4/P4 |
Suspended
330

Midpin G3 | Single Suspended



DE LED-Strahler für Pendelmontage. Direktstrahlend. Konverter in Leuchtgehäuse integriert, wahlweise einfach schaltbar oder stufenlos dimmbar (DALI). Gehäuse aus Aluminium in weiß, silber, schwarz oder champagnerfarben lackiert. Weitere Oberflächenoptionen siehe Lightnet Surface Collection oder RAL nach Wahl. Farbtemperatur wahlweise 2700K, 3000K oder 4000K oder als Dim to Warm 3000K-1800K. Farbwiedergabe CRI>90. Binning initial \leq MacAdam 3. Austauschbare Linsenoptik mit Ausstrahlwinkel 30° (Medium) oder 40° (Flood). Optikring in verschiedenen Farbausführungen erhältlich. Zuleitungskabel wahlweise transparent, rot oder schwarz.

EN LED spotlight for pendant mounting. Direct only light distribution. Driver integrated into luminaire housing, optionally switchable or dimmable (DALI). Housing made of white, silver, black or champagne coated aluminum. Further surface options see Lightnet-Surface-Collection or RAL of your choice. Colour temperature available as 2700K, 3000K or 4000K or as Dim to Warm 3000K-1800K. Colour rendering CRI>90. Binning \leq MacAdam 3. Changeable lens optics with beam angle 30° (medium) or 40° (flood). Optic ring available in different colour versions. Optionally transparent, red or black supply line.

D G3 B B E - 9 27 M - G B

Product Family	D: Midpin
Type	G3: Direct only
Lens Angle	B: Medium 30°, C: Flood 40°
Surface Finish	W: Snow White, V: Ivory White, S: Radiant Silver, B: Jet Black, H: Anodic Champagne
Control Gear	E: On/Off, L: DALI, H: Touch-Dim
Colour Rendering	9: CRI>90
Colour Temperature	27: 2700K, 30: 3000K, 35: 3500K, 40: 4000K, DW: Dim to Warm 1800K-3000K [DALI only]
Power	M: Medium Power
Optic Ring	W: Snow White, V: Ivory White, S: Radiant Silver, B: Jet Black, H: Anodic Champagne, G: Satin Gold, K: Satin Copper
Cable Colour	T: Transparent, R: Red, B: Black



Medium 30° Led Engine Eco, Medium Power

Mounting Height	Illuminance [Lux] center/side	Beam Diameter
1 m	2079/929	0.57 m
2 m	520/232	1.10 m
3 m	231/103	1.70 m
4 m	130/58	2.30 m

LED Engine	2700K	3000K	3500K	4000K
11W	610 lm	710 lm	750 lm	750 lm

Flood 40° Led Engine Eco, Medium Power

Mounting Height	Illuminance [Lux] center/side	Beam Diameter
1 m	1454/591	0.77 m
2 m	364/148	1.50 m
3 m	162/66	2.30 m
4 m	91/37	3.10 m

LED Engine	2700K	3000K	3500K	4000K
11W	620 lm	730 lm	770 lm	770 lm

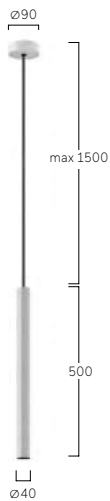

B Jet Black
W Snow White



B Jet Black
A Satin Silver



B Jet Black
B Jet Black

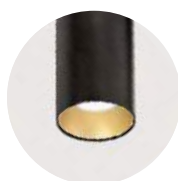

B Jet Black
G Satin Gold



B Jet Black
H Anodic Champagne

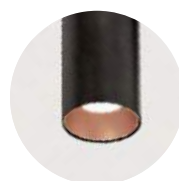

B Jet Black
K Satin Copper

Midpoint Suspended



Private Residence Cossio 829
Mexico City, Mexico
Midpoint P7



Inwerk – Office Culture Forum, Meerbusch, Germany
Midpoint P7
Photography: Tomas Rodriguez

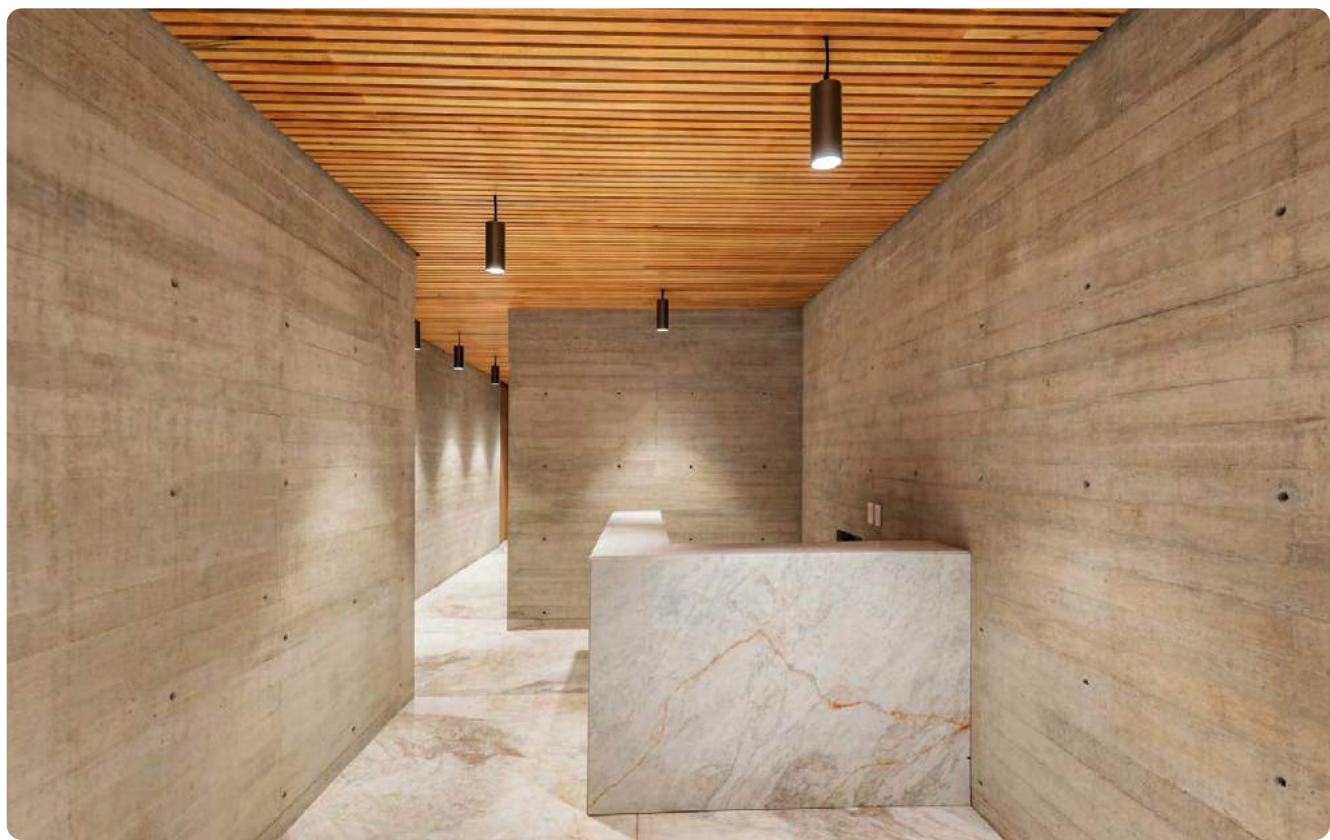

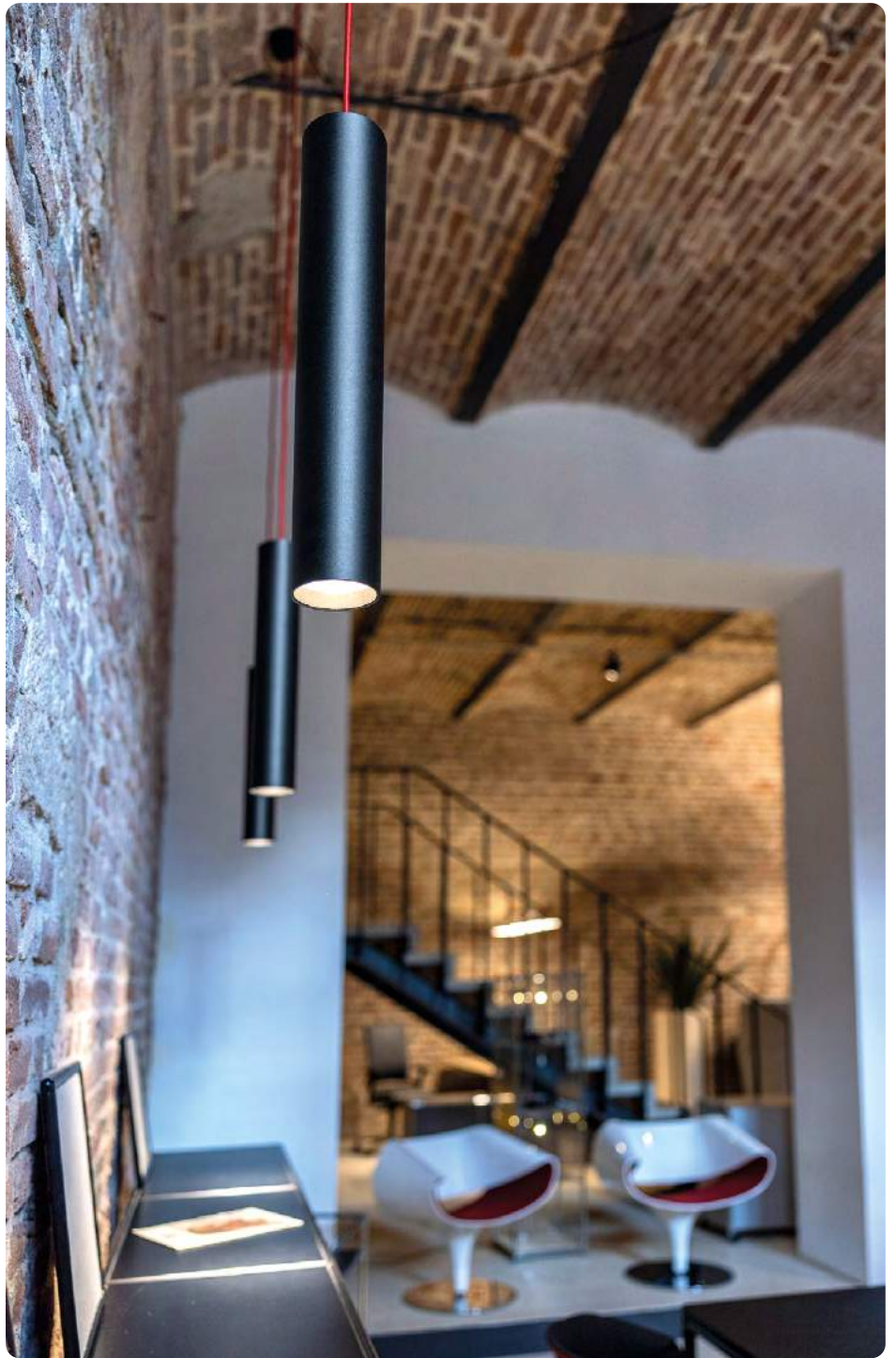

Private Residence Cossio 829
Mexico City, Mexico
Midpoint P7

Inwerk – Office Culture Forum, Meerbusch, Germany
Midpoint P7

Photography: Tomas Rodriguez

Midpoint P7/P8 | Suspended



DE LED-Strahler für Pendelmontage. Direktstrahlend. Konverter in Leuchtenkörper integriert, wahlweise einfach schaltbar oder stufenlos dimmbar (DALI). Gehäuse aus Aluminium in weiß, silber, schwarz oder champagnerfarben lackiert. Weitere Oberflächenoptionen siehe Lightnet Surface Collection oder RAL nach Wahl. LED Engine wahlweise XICATO ARTIST für höchste Lichtqualität mit bester Farbwiedergabe und 5 Jahre Garantie für Farbkonstanz (MacAdam \leq 3) oder ECO für höchste Energieeffizienz bei optimalem Preis-Leistungsverhältnis und CRI>90. Farbtemperaturen 2700K, 3000K oder 4000K. Austauschbare Linsen-Reflektoroptiken mit sphärischer Facettenoptik. Ausstrahlwinkel: 10° (Spot), 20° (Medium), 35° (Flood) oder 50° (Wide Flood). Reflektorring in verschiedenen Farbausführungen erhältlich. Standardmäßig klare Abdeckung. Optional zusätzliche Filter oder Wabenraster. Zuleitungskabel wahlweise transparent, rot oder schwarz.

EN LED spotlight for pendant mounting. Direct only light distribution. Driver integrated into luminaire body, optionally switchable or dimmable (DALI). Housing made of white, silver, black or champagne coated aluminum. Further surface options see Lightnet-Surface-Collection or RAL of your choice. LED Engine with XICATO ARTIST for highest light quality and colour rendering, including 5-year warranty for colour consistency (MacAdams 3) or ECO for highest energy efficiency with optimal price-performance ratio and CRI> 90. Colour temperature 2700K, 3000K or 4000K. Replaceable lens reflector optic with spherical faceted optic. Beam angle: 10° (Spot), 20° (Medium), 35° (Flood) or 50° (Wide Flood). Reflector ring available in different colour versions. Standard clear cover. Optional additional filters or honeycomb louvre. Option of transparent, red or black power supply cable.

PP7 BSE-927FM-BKR

Product Family	P: Midpoint
Type	P7: Direct [Tube: 215mm], P8: Direct [Tube: 500mm]
Beam Angle	A: Spot 10°, B: Medium 20°, C: Flood 35°, D: Wide Flood 50°
Surface Finish	W: Snow White, V: Ivory White, S: Radiant Silver, B: Jet Black, H: Anodic Champagne
Control Gear	E: On/Off, L: DALI, H: Touch-Dim
Colour Rendering	9: CRI>90
Colour Temperature	27: 2700K, 30: 3000K, 40: 4000K
Led-Engine	F: Eco [Ra> 90], A: Artist [Ra> 97, Xicato]
Power	E: Low Power M: Medium Power
Optic Ring	W: Snow White, V: Ivory White, S: Radiant Silver, B: Jet Black, H: Anodic Champagne, G: Satin Gold, K: Satin Copper
Cover	K: Clear Cover [Standard], P: Prismatic Lens, H: Honeycomb Louvre
Cable Colour	T: Transparent, R: Red, B: Black
On Request	Optic Removal Tool for clear cover



Spot 10° Led Engine Eco, Medium Power

Mounting Height	Illuminance[Lux] center/side	Beam Diameter
1 m	25250/12700	0.24 m
2 m	6312/3175	0.48 m
3 m	2806/1411	0.72 m
4 m	1578/794	0.95 m

LED Engine	2700K	3000K	4000K
Eco Low			
Power [19W]	1230 lm	1350 lm	1440 lm
Eco Medium			
Power [31W]	1660 lm	1860 lm	2020 lm
Artist Low			
Power [19W]	1040 lm	1090 lm	1190 lm
Artist Medium			
Power [31W]	1400 lm	1480 lm	1560 lm

Medium 20° Led Engine Eco, Medium Power

Mounting Height	Illuminance[Lux] center/side	Beam Diameter
1 m	17447/8455	0.32 m
2 m	4362/2114	0.64 m
3 m	1939/939	0.96 m
4 m	1090/528	1.30 m

LED Engine	2700K	3000K	4000K
Eco Low			
Power [19W]	1580 lm	1740 lm	1850 lm
Eco Medium			
Power [31W]	2360 lm	2640 lm	2870 lm
Artist Low			
Power [19W]	1330 lm	1390 lm	1510 lm
Artist Medium			
Power [31W]	1980 lm	2110 lm	2220 lm

Flood 35° Led Engine Eco, Medium Power

Mounting Height	Illuminance[Lux] center/side	Beam Diameter
1 m	6251/2731	0.63 m
2 m	1563/683	1.30 m
3 m	695/303	1.90 m
4 m	391/171	2.50 m

LED Engine	2700K	3000K	4000K
Eco Low			
Power [19W]	1530 lm	1680 lm	1790 lm
Eco Medium			
Power [31W]	2280 lm	2550 lm	2780 lm
Artist Low			
Power [19W]	1290 lm	1350 lm	1470 lm
Artist Medium			
Power [31W]	1930 lm	2060 lm	2160 lm

Wide Flood 50° Led Engine Eco, Medium Power

Mounting Height	Illuminance[Lux] center/side	Beam Diameter
1 m	3550/1319	0.94 m
2 m	887/330	1.90 m
3 m	394/147	2.80 m
4 m	222/82	3.80 m

LED Engine	2700K	3000K	4000K
Eco Low			
Power [19W]	1440 lm	1580 lm	1680 lm
Eco Medium			
Power [31W]	2230 lm	2490 lm	2710 lm
Artist Low			
Power [19W]	1250 lm	1310 lm	1430 lm
Artist Medium			
Power [31W]	1910 lm	2040 lm	2140 lm

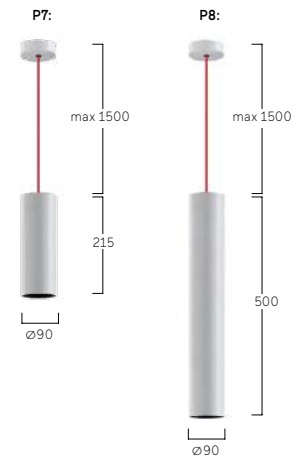

Basic Superflat Suspended



Satellite Office Opernplatz Frankfurt, Germany
Basic P5
Photography: Moritz Bernouilly, www.satelliteoffice.de



Satellite Office Opernplatz Frankfurt, Germany
Basic P5
Photography: Moritz Bernouilly, www.satelliteoffice.de

Perfect Hair, Wallisellen, Switzerland
Basic P7
Planner: Daniel Huber Architekten,
implementation and Photography: Mabalux AG



Basic Superflat G7/P7 | Suspended



DE LED-Pendelleuchte. Direkt-indirekt oder rein direktstrahlend. Gestufter Leuchtenkörper aus Aluminiumprofil mit lediglich 18mm sichtbarem Rahmenprofil. Oberfläche weiß, silber, graphit, schwarz, champagner oder kupferfarben lackiert. Weitere Oberflächenoptionen siehe Lightnet-Surface-Collection oder RAL nach Wahl. Microprismenoptik mit optimierter Blendungsbegrenzung speziell für Office-Anwendungen. Satinierter Opaldiffusor für Allgemeinbeleuchtung mit max. Transmissionsgrad und homogener Lichtpunktauflösung. Konverter in Leuchtgehäuse integriert, wahlweise einfach schaltbar oder stufenlos dimmbar (DALI, Touch-Dim, Casambi). Farbtemperatur 2200K, 2700K, 3000K, 3500K, 4000K, 6500K oder Tunable White (2700-6500K). Binning initial \leq MacAdam 3. Farbwiedergabe CRI $>$ 80, CRI $>$ 90 oder Full Spectrum. Stufenlos höhenverstellbare Zentral-Seilabhängung mit transparent ummantelter Zuleitung oder Pendelrohrabhängung. Lackierung Baldachin und Pendelrohr passend Leuchtenkörper. Auf Anfrage: Integration von Notlichtkomponenten, Sensortechnologie.

EN LED pendant luminaire. Direct-indirect or direct-only light distribution. Tiered luminaire body made of aluminium profile with 18mm visible frame. Surface white, silver, graphite, black, champagne or copper coated. Further surface options see Lightnet-Surface-Collection or RAL of your choice. Microprismatic screen with optimized glare reduction especially for work-places. Satin opal diffuser for general lighting with maximum transmittance and homogeneous lighting. Driver integrated into luminaire housing, optionally switchable or dimmable (DALI, Touch-Dim, Casambi). Colour temperature 2200K, 2700K, 3000K, 3500K, 4000K, 6500K or Tunable White (2700-6500K). Binning \leq MacAdam 3. Colour rendering CRI $>$ 80, CRI $>$ 90 or Full Spectrum. Height-adjustable central cord suspension with transparent power supply cable or rod suspension match to luminaire body. On request: Integration of emergency lighting components, sensor technology.

BP7ASL-830M-D500-U

Product Family	B: Basic
Type	P7: Direct-Indirect, G7: Direct only
Optical System	A: Microprismatic, O: Opal Diffuser
Surface Finish	W: Snow White, V: Ivory White, S: Radiant Silver, U: Urban Graphite, B: Jet Black, H: Anodic Champagne, K: Satin Copper
Control Gear	E: On/Off, L: DALI, H: Touch-Dim, C: Casambi, 6: DALI DT6 for TW, 8: DALI DT8 for TW
Colour Rendering	8: CRI>80, 9: CRI>90, F: Full Spectrum [except 2200K]
Colour Temperature	22: 2200K, 27: 2700K, 30: 3000K, 35: 3500K, 40: 4000K, 65: 6500K, TW: Tunable White 2700-6500K [D400-D800]
Power	M: Medium Power, H: High Power
Size	Luminaire Diameter in mm: D300, D400, D500, D600, D800
Suspension	U: Central Suspension, P: Tube Suspension [D400-D800]
On Request	Multisensor [D400-D800], Radar Sensor, Emergency Module [D400-D800]



Microprismatic Direct-Indirect			Microprismatic Direct			Opal Diffuser Direct-Indirect			Opal Diffuser Direct		
D mm	Lumen/Watt Medium Power	Lumen/Watt High Power	D mm	Lumen/Watt Medium Power	Lumen/Watt High Power	D mm	Lumen/Watt Medium Power	Lumen/Watt High Power	D mm	Lumen/Watt Medium Power	Lumen/Watt High Power
300	1260lm/11W	2150lm/18W	300	690lm/7W	1190lm/11W	300	1270lm/11W	2160lm/18W	300	700lm/7W	1200lm/11W
400	2330lm/18W	4050lm/31W	400	1470lm/12W	2560lm/21W	400	2350lm/18W	4070lm/31W	400	1490lm/12W	2580lm/21W
500	3000lm/23W	5240lm/40W	500	2030lm/16W	3570lm/28W	500	3040lm/23W	5300lm/40W	500	2070lm/16W	3630lm/28W
600	5380lm/40W	8270lm/63W	600	3390lm/25W	5520lm/42W	600	5450lm/40W	8370lm/63W	600	3460lm/25W	5620lm/42W
800	7860lm/60W	10750lm/81W	800	5160lm/40W	6980lm/54W	800	7980lm/60W	10920lm/81W	800	5280lm/40W	7150lm/54W

Lumen Values: Luminaire luminous flux at 4000K/CRI>80. Other configurations on request.



Basic Neo Suspended

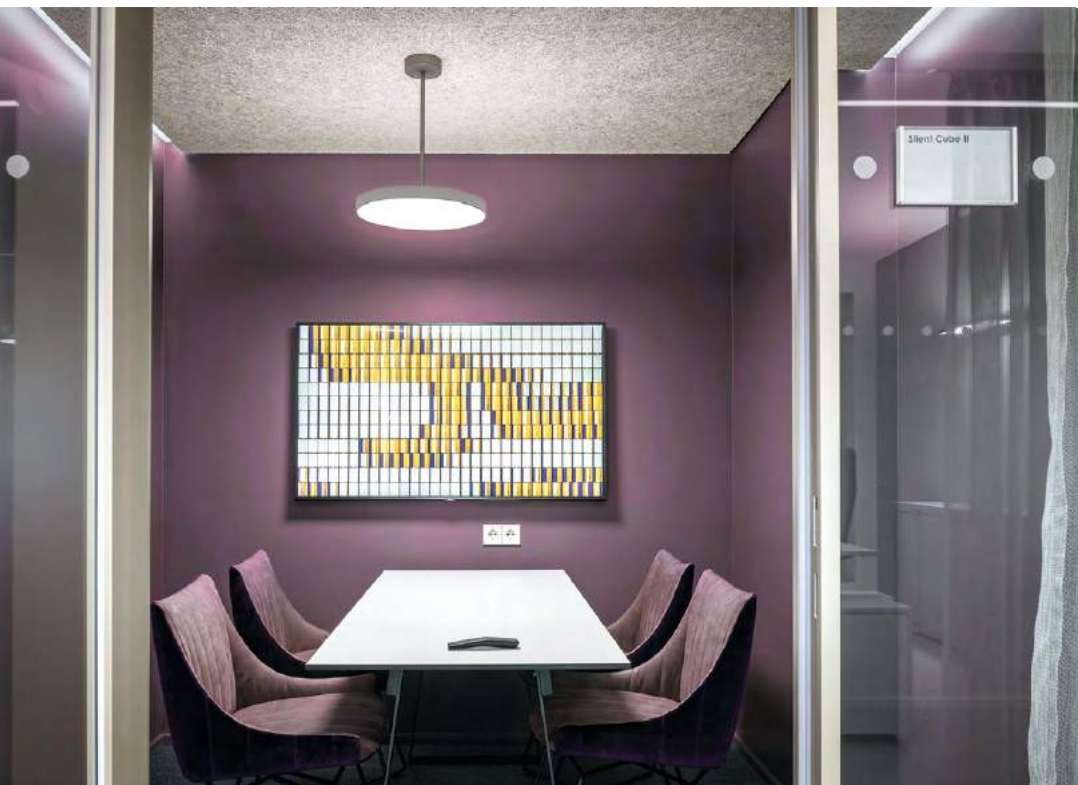

Satellite Office Opernplatz

Frankfurt, Germany

Basic P5

Photography: Moritz Bernouly, www.satelliteoffice.de



Microsoft, Cologne, Germany
Basic G5

Photography: HGEsch, Planning: corinna arens and
dorette faulhaber, Lepel & Lepel architects

Basic Neo G5/P5 | Suspended



DE LED-Pendelleuchte. Direkt-indirekt oder rein direktstrahlend. Leuchtenkörper aus Aluminiumprofil mit filigraner Bauhöhe von 38mm ohne zusätzliche Aufbauten. Oberfläche weiß, silber, graphit, schwarz, champagner oder kupferfarben lackiert. Weitere Oberflächenoptionen siehe Lightnet-Surface-Collection oder RAL nach Wahl. Microprismenoptik mit optimierter Blendungsbegrenzung speziell für Office-Anwendungen. Satiniertes Opaldiffusor für Allgemeinbeleuchtung mit max. Transmissionsgrad und homogener Lichtpunktauflösung. Konverter in Leuchtgehäuse integriert, wahlweise einfach schaltbar oder stufenlos dimmbar (DALI, Touch-Dim, Casambi). Farbtemperatur 2200K, 2700K, 3000K, 3500K, 4000K, 6500K oder Tunable White (2700-6500K). Binning initial \leq MacAdam 3. Farbwiedergabe $\text{CRI} > 80$, $\text{CRI} > 90$ oder Full Spectrum. Stufenlos höhenverstellbare Zentral-Seilabhängung mit transparent ummantelter Zuleitung oder Pendelrohrabhängung. Lackierung Baldachin und Pendelrohr passend Leuchtenkörper. Auf Anfrage: Integration von Notlichtkomponenten, Sensortechnologie.

EN LED pendant luminaire. Direct-indirect or direct-only light distribution. Luminaire body made of aluminium profile with slender overall height of 38mm without additional attachments. Surface white, silver, graphite, black, champagne or copper coated. Further surface options see Lightnet-Surface-Collection or RAL of your choice. Microprismatic screen with optimized glare reduction especially for workplaces. Satin opal diffuser for general lighting with maximum transmittance and homogeneous lighting. Driver integrated into luminaire housing, optionally switchable or dimmable (DALI, Touch-Dim, Casambi). Colour temperature 2200K, 2700K, 3000K, 3500K, 4000K, 6500K or Tunable White (2700-6500K). Binning \leq MacAdam 3. Colour rendering $\text{CRI} > 80$, $\text{CRI} > 90$ or Full Spectrum. Height-adjustable central cord suspension with transparent power supply cable or rod suspension. Colours ceiling rose and rod suspension match to luminaire body. On request: Integration of emergency lighting components, sensor technology.

B P5 A SL-8 30 M-D300-U

Product Family **B:** Basic

Type **P5:** Direct-Indirect, **G5:** Direct only

Optical System **A:** Microprismatic, **O:** Opal Diffuser

Surface Finish **W:** Snow White, **V:** Ivory White, **S:** Radiant Silver, **U:** Urban Graphite, **B:** Jet Black, **H:** Anodic Champagne, **K:** Satin Copper

Control Gear **E:** On/Off, **L:** DALI, **H:** Touch-Dim, **C:** Casambi [D400-D800], **6:** DALI DT6 for TW, **8:** DALI DT8 for TW

Colour Rendering **8:** CRI>80, **9:** CRI>90, **F:** Full Spectrum [except 2200K]

Colour Temperature **22:** 2200K, **27:** 2700K, **30:** 3000K, **35:** 3500K, **40:** 4000K, **65:** 6500K, **TW:** Tunable White 2700-6500K [D400-D800]

Power **M:** Medium Power, **H:** High Power

Size Luminaire Diameter in mm: **D300, D400, D500, D600, D800**

Suspension **U:** Central Suspension, **P:** Tube Suspension [D400-D800]

On Request Multisensor [D400-D800], Radar Sensor, Emergency Module [D400-D800]



Microprismatic | Direct-Indirect

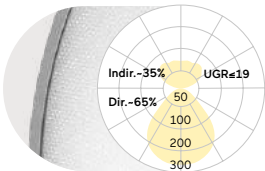

D mm	Lumen/Watt Medium Power	Lumen/Watt High Power
300	1210lm/11W	2070lm/18W
400	2260lm/18W	3920lm/31W
500	2920lm/23W	5100lm/40W
600	5210lm/40W	8040lm/63W
800	7630lm/60W	10430lm/81W

Microprismatic | Direct

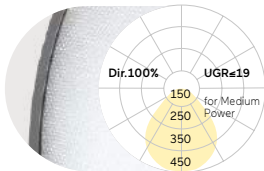

D mm	Lumen/Watt Medium Power	Lumen/Watt High Power
300	690lm/7W	1190lm/11W
400	1470lm/12W	2560lm/21W
500	2030lm/16W	3570lm/28W
600	3390lm/25W	5520lm/42W
800	5160lm/40W	6980lm/54W

Opal Diffuser | Direct-Indirect

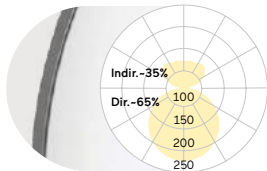

D mm	Lumen/Watt Medium Power	Lumen/Watt High Power
300	1220lm/11W	2080lm/18W
400	2280lm/18W	3940lm/31W
500	2960lm/23W	5160lm/40W
600	5280lm/40W	8140lm/63W
800	7750lm/60W	10600lm/81W

Opal Diffuser | Direct

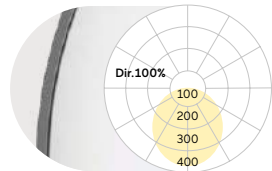

D mm	Lumen/Watt Medium Power	Lumen/Watt High Power
300	700lm/7W	1200lm/11W
400	1490lm/12W	2580lm/21W
500	2070lm/16W	3630lm/28W
600	3460lm/25W	5620lm/42W
800	5280lm/40W	7150lm/54W

Lumen Values: Luminaire luminous flux at 4000K/CRI>80. Other configurations on request.

Tube Suspension



Central Suspension



Multisensor



Emergency Module



W Snow White



S Radiant Silver



U Urban Graphite



B Jet Black



H Anodic Champagne



K Satin Copper

Basic Déco Suspended





Estoty, Vilnius, Lithuania
Basic G3
Photography: Leonas Garbačauskas



Basic Déco G3/P3 | Suspended



DE LED-Pendelleuchte. Direkt-indirekt oder rein direktstrahlend. Leuchtenkörper aus Aluminiumprofil mit Bauhöhe 58mm. Gehäuse-Außenfläche und dekorativer Reflekterring in unterschiedlichen Lackierungen und Kombinationen erhältlich, z.B. weiß, silber, graphit, schwarz, gold oder kupferfarben. Zu Oberflächenoptionen- und Kombinationen siehe Lightnet-Surface-Collection oder Bi-Colour-Auswahl. Rückversetzte Microprismenoptik mit optimierter Blendungsbegrenzung speziell für Office-Anwendungen. Satinierter Opaldiffusor für Allgemeinbeleuchtung mit max. Transmissionsgrad und homogener Lichtpunktauflösung. Konverter in Leuchtgehäuse integriert, wahlweise einfach schaltbar oder stufenlos dimmbar (DALI, Touch-Dim, Casambi). Farbtemperatur 2200K, 2700K, 3000K, 3500K, 4000K, 6500K oder Tunable White (2700-6500K). Binning initial \leq MacAdam 3. Farbwiedergabe CRI>80, CRI>90 oder Full Spectrum. Stufenlos höhenverstellbare Zentral-Seilabhängung mit transparent ummantelter Zuleitung oder Pendelrohrabhängung. Lackierung Baldachin und Pendelrohr passend Leuchtenkörper. Auf Anfrage: Integration von Notlichtkomponenten, Sensortechnologie.

EN LED pendant luminaire. Direct-indirect or direct-only light distribution. Luminaire body made of aluminium profile with overall height of 58mm. Luminaire housing and Decorative reflector ring available in various finishes and combinations, e.g. white, silver, graphite, black, gold or copper coated. Further surface options see Lightnet-Surface-Collection or RAL of your choice. Recessed micropismatic screen with optimized glare reduction especially for workplaces. Satin opal diffuser for general lighting with maximum transmittance and homogeneous lighting. Driver integrated into luminaire housing, optionally switchable or dimmable (DALI, Touch-Dim, Casambi). Colour temperature 2200K, 2700K, 3000K, 3500K, 4000K, 6500K or Tunable White (2700-6500K). Binning \leq MacAdam 3. Colour rendering CRI>80, CRI>90 or Full Spectrum. Height-adjustable central cord suspension with transparent power supply cable or rod suspension. Colours ceiling rose and rod suspension match to luminaire body. On request: Integration of emergency lighting components, sensor technology.

BP3ASL-830M-D500-UG

- Product Family **B:** Basic
- Type **P3:** Direct-Indirect, **G3:** Direct only
- Optical System **A:** Microprismatic, **O:** Opal Diffuser
- Surface Finish **W:** Snow White, **V:** Ivory White, **S:** Radiant Silver, **U:** Urban Graphite, **B:** Jet Black, **H:** Anodic Champagne, **K:** Satin Copper
- Control Gear **E:** On/Off, **L:** DALI, **H:** Touch-Dim, **C:** Casambi, **6:** DALI DT6 for TW, **8:** DALI DT8 for TW
- Colour Rendering **8:** CRI>80, **9:** CRI>90, **F:** Full Spectrum [except 2200K]
- Colour Temperature **22:** 2200K, **27:** 2700K, **30:** 3000K, **35:** 3500K, **40:** 4000K, **65:** 6500K, **TW:** Tunable White 2700-6500K [D400-D800]
- Power **M:** Medium Power, **H:** High Power
- Size Luminaire Diameter in mm: **D300, D400, D500, D600, D800**
- Suspension **U:** Central Suspension, **P:** Tube Suspension [D400-D800]
- Reflector **W:** Snow White, **V:** Ivory White, **S:** Radiant Silver, **U:** Urban Graphite, **B:** Jet Black, **H:** Anodic Champagne, **K:** Satin Copper, **G:** Satin Gold
- On Request Multisensor [D400-D800], Radar Sensor, Emergency Module [D400-D800]



Microprismatic | Direct-Indirect

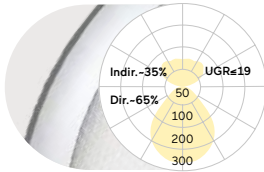

D mm	Lumen/Watt Medium Power	Lumen/Watt High Power
300	1480lm/13W	2530lm/23W
400	2370lm/20W	3750lm/31W
500	3500lm/29W	5810lm/48W
600	5380lm/43W	7750lm/63W
800	7830lm/63W	9940lm/82W

Microprismatic | Direct

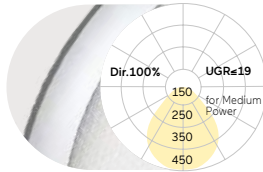

D mm	Lumen/Watt Medium Power	Lumen/Watt High Power
300	830lm/8W	1430lm/13W
400	1500lm/14W	2410lm/21W
500	2370lm/21W	3980lm/35W
600	3560lm/28W	5230lm/42W
800	5360lm/44W	6490lm/55W

Opal Diffuser | Direct-Indirect

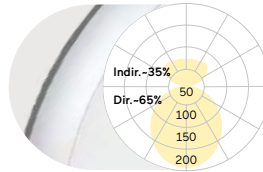

D mm	Lumen/Watt Medium Power	Lumen/Watt High Power
300	1460lm/13W	2500lm/23W
400	2370lm/20W	3750lm/31W
500	3520lm/29W	5870lm/48W
600	5470lm/43W	7850lm/63W
800	7980lm/63W	10110lm/82W

Opal Diffuser | Direct

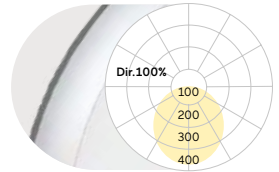

D mm	Lumen/Watt Medium Power	Lumen/Watt High Power
300	810lm/8W	1400lm/13W
400	1500lm/14W	2410lm/21W
500	2390lm/21W	4040lm/35W
600	3650lm/28W	5330lm/42W
800	5510lm/44W	6660lm/55W

Lumen Values: Luminaire luminous flux at 4000K/CRI>80. Other configurations on request.

Tube Suspension

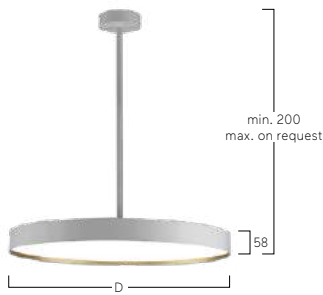

Central Suspension



Multisensor



Emergency Module



W Snow White
W Snow White



S Radiant Silver
S Radiant Silver



U Urban Graphite
U Urban Graphite



B Jet Black
B Jet Black



H Anodic Champagne
H Anodic Champagne



K Satin Copper
K Satin Copper



W Snow White
K Satin Copper

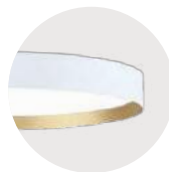

W Snow White
G Satin Gold



W Snow White
B Jet Black



H Anodic Champagne
B Jet Black



B Jet Black
G Satin Gold

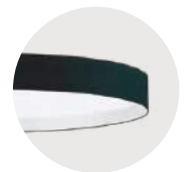

B Jet Black
W Snow White

Basic Déco XXL G4/P4 | Suspended



DE LED-Pendelleuchte. Direkt-indirekt oder rein direktstrahlend. Leuchtenkörper aus Aluminiumprofil mit Bauhöhe 100mm. Gehäuse-Außenfläche und dekorativer Reflektoring in unterschiedlichen Lackierungen und Kombinationen erhältlich, z.B. weiß, silber, graphit, schwarz, gold oder kupferfarben. Zu Oberflächenoptionen- und Kombinationen siehe Lightnet-Surface-Collection oder Bi-Colour-Auswahl. Rückversetzte Microprismenoptik mit optimierter Blendungsbegrenzung speziell für Office-Anwendungen (bis max. Ø1200). Opal diffusor aus satiniertem Acrylglas. Konverter in Leuchtengehäuse integriert, wahlweise einfach schaltbar oder stufenlos dimmbar (DALI, Touch-Dim, Casambi). Farbtemperatur 2200K, 2700K, 3000K, 3500K, 4000K, 6500K oder Tunable White (2700-6500K). Binning initial \leq MacAdam 3. Farbwiedergabe $\text{CRI} > 80$, $\text{CRI} > 90$ oder Full Spectrum. Stufenlos höhenverstellbare Zentral-Seilabhangung (max. Ø1500) oder Parallel-Seilabhangung mit transparent ummantelter Zuleitung, alternativ Pendelrohrabhangung. Lackierung Baldachin und Pendelrohr passend Leuchtenkorper. Auf Anfrage: Integration von Notlichtkomponenten, Sensortechnologie.

EN LED pendant luminaire. Direct-indirect or direct-only light distribution. Luminaire body made of aluminium profile with overall height of 100mm. Outer housing and Decorative reflector ring available in various finishes and combinations, e.g. white, silver, graphite, black, gold or copper coated. Further surface options see Lightnet-Surface-Collection or RAL of your choice. Recessed microprismatic screen with optimized glare reduction especially for workplaces (up to max. Ø1200). Opal diffuser made of acrylic glass. Driver integrated into luminaire housing, optionally switchable or dimmable (DALI, Touch-Dim, Casambi). Colour temperature 2200K, 2700K, 3000K, 3500K, 4000K, 6500K or Tunable White (2700-6500K). Binning \leq MacAdam 3. Colour rendering $\text{CRI} > 80$, $\text{CRI} > 90$ or Full Spectrum. Height-adjustable central cord suspension (max. Ø1500) or parallel cord suspension with transparent power supply cable or rod suspension. Colours ceiling rose and rod suspension match to luminaire body. On request: Integration of emergency lighting components, sensor technology.

BP4ASL-830M-D500-UG

- Product Family **B:** Basic
- Type **P4:** Direct-Indirect, **G4:** Direct only
- Optical System **A:** Microprismatic [D300-D1200], **O:** Opal Diffuser
- Surface Finish **W:** Snow White, **V:** Ivory White, **S:** Radiant Silver, **U:** Urban Graphite, **B:** Jet Black, **H:** Anodic Champagne, **K:** Satin Copper
- Control Gear **E:** On/Off, **L:** DALI, **H:** Touch-Dim, **C:** Casambi, **6:** DALI DT6 for TW, **8:** DALI DT8 for TW
- Colour Rendering **8:** CRI>80, **9:** CRI>90, **F:** Full Spectrum [except 2200K]
- Colour Temperature **22:** 2200K, **27:** 2700K, **30:** 3000K, **35:** 3500K, **40:** 4000K, **65:** 6500K, **TW:** Tunable White 2700-6500K [D400-D1200]
- Power **E:** Low Power, **M:** Medium Power
- Size Luminaire Diameter in mm: **D300, D400, D500, D600, D900, D1200, D1500**
- Suspension **U:** Central Suspension, **P:** Tube Suspension [D400-D900], **K:** Parallel Suspension
- Reflector **W:** Snow White, **V:** Ivory White, **S:** Radiant Silver, **U:** Urban Graphite, **B:** Jet Black, **H:** Anodic Champagne, **K:** Satin Copper, **G:** Satin Gold
- On Request Multisensor [D400-D1500], Radar Sensor, Emergency Module [D400-D1500]



Microprismatic Direct-Indirect			Microprismatic Direct			Opal Diffuser Direct-Indirect			Opal Diffuser Direct		
D mm	Lumen/Watt Low Power	Lumen/Watt Medium Power	D mm	Lumen/Watt Low Power	Lumen/Watt Medium Power	D mm	Lumen/Watt Low Power	Lumen/Watt Medium Power	D mm	Lumen/Watt Low Power	Lumen/Watt Medium Power
300	1440lm/12W	2810lm/21W	300	880lm/8W	1730lm/14W	300	1470lm/12W	2860lm/21W	300	910lm/8W	1780lm/14W
400	2800lm/19W	5740lm/40W	400	1740lm/13W	3580lm/29W	400	2850lm/19W	5850lm/40W	400	1790lm/13W	3690lm/29W
500	3970lm/29W	7760lm/53W	500	2480lm/18W	4860lm/35W	500	4040lm/29W	7910lm/53W	500	2550lm/18W	5010lm/35W
600	8370lm/55W	12900lm/87W	600	3860lm/28W	7250lm/52W	600	8490lm/55W	13120lm/87W	600	3980lm/28W	7470lm/52W
900	11330lm/88W	17110lm/144W	900	6800lm/59W	11490lm/106W	900	11530lm/88W	17450lm/144W	900	7000lm/59W	11830lm/106W
1200	18140lm/143W	28870lm/251W	1200	11890lm/107W	20110lm/195W	1200	18500lm/143W	29460lm/251W	1200	12250lm/107W	20700lm/195W
						1500	20850lm/181W	34360lm/324W	1500	17290lm/162W	28950lm/287W

Lumen Values: Luminaire luminous flux at 4000K/CRI>80. Other configurations on request.

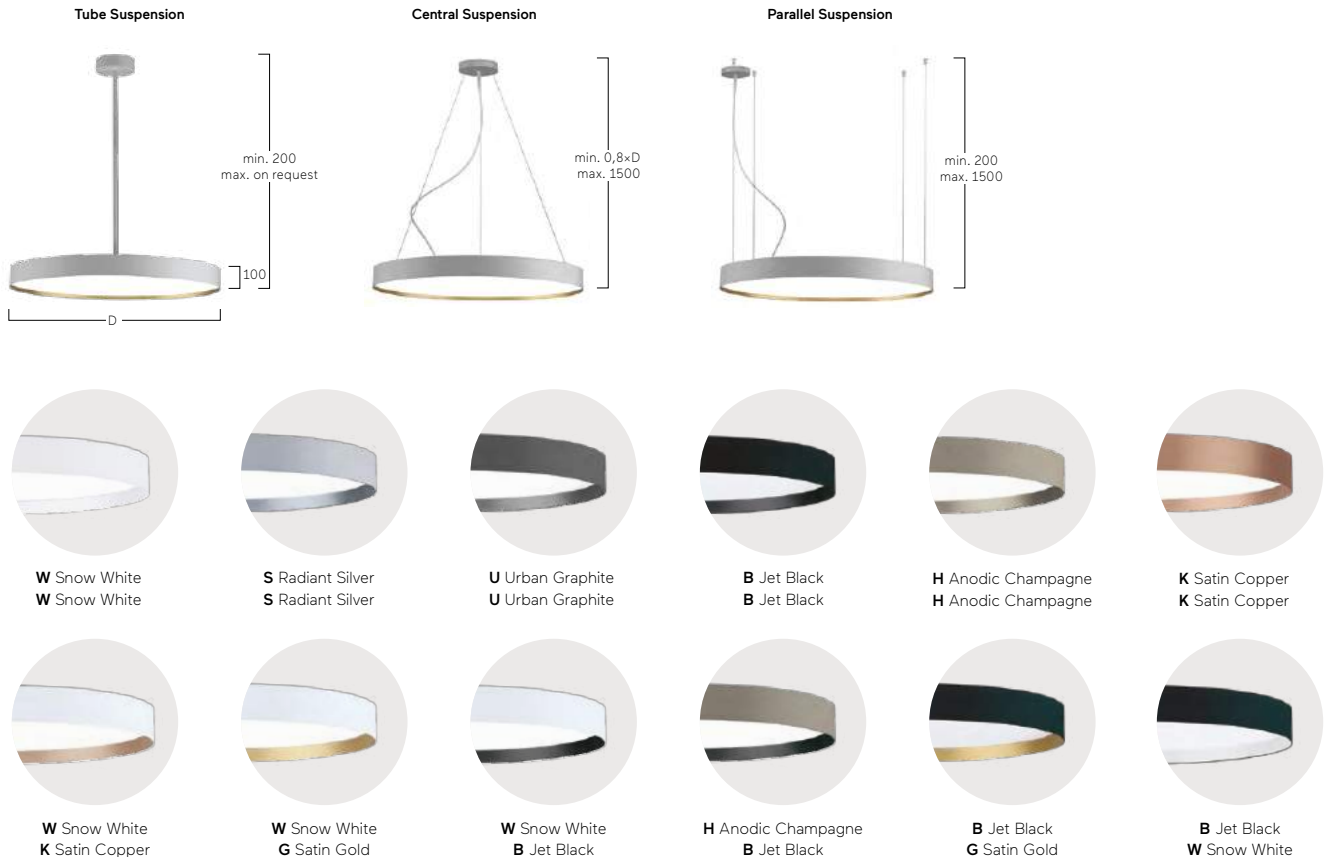

Basic Déco O3 | Suspended



DE LED-Strahler für Pendelmontage. 350° drehbar und 90° schwenkbar. Leuchtenkörper aus Aluminiumprofil mit Bauhöhe 58mm. Gehäuse-Außenfläche und dekorativer Reflektorring in unterschiedlichen Lackierungen und Kombinationen erhältlich, z.B. weiß, silber, graphit, schwarz, gold oder kupferfarben. Zu Oberflächenoptionen- und Kombinationen siehe Lightnet-Surface-Collection oder Bi-Colour-Auswahl. Rückversetzte Microprismenoptik mit optimierter Blendungsbegrenzung speziell für Office-Anwendungen. Satinierter Opaldiffusor für Allgemeinbeleuchtung mit max. Transmissionsgrad und homogener Lichtpunktauflösung. Konverter in Leuchtgehäuse integriert, wahlweise einfach schaltbar oder stufenlos dimmbar (DALI, Touch-Dim, Casambi). Farbtemperatur 2200K, 2700K, 3000K, 3500K, 4000K oder 6500K. Binning initial \leq MacAdam 3. Farbwiedergabe CRI $>$ 80, CRI $>$ 90 oder Full Spectrum.

EN LED spotlight for pendant mounting. 350° rotation and 90° tilt. Luminaire body made of aluminium profile with overall height of 58mm. Outer housing and Decorative reflector ring available in various finishes and combinations, e.g. white, silver, graphite, black, gold or copper coated. For further surface options see Lightnet-Surface-Collection or RAL of your choice. Recessed microprismatic screen with optimized glare reduction especially for workplaces. Satin opal diffuser for general lighting with maximum transmittance and homogeneous lighting. Driver integrated into luminaire housing, optionally switchable or dimmable (DALI, Touch-Dim, Casambi). Colour temperature 2200K, 2700K, 3000K, 3500K, 4000K or 6500K. Binning \leq MacAdam 3. Colour rendering CRI $>$ 80, CRI $>$ 90 or Full Spectrum.

B O3 A W E-8 30 M- D300-PG

Product Family	B: Basic
Type	O3: Direct only
Optical System	A: Microprismatic, O: Opal Diffuser
Surface Finish	W: Snow White, V: Ivory White, S: Radiant Silver, U: Urban Graphite, B: Jet Black, H: Anodic Champagne, K: Satin Copper
Control Gear	E: On/Off, L: DALI, H: Touch-Dim, C: Casambi [D400-D600], 6: DALI DT6 for TW, 8: DALI DT8 for TW
Colour Rendering	8: CRI>80, 9: CRI>90, F: Full Spectrum [except 2200K]
Colour Temperature	22: 2200K, 27: 2700K, 30: 3000K, 35: 3500K, 40: 4000K, 65: 6500K, TW: Tunable White 2700-6500K [D400-D600]
Power	M: Medium Power, H: High Power
Size	Luminaire Diameter in mm: D300, D400, D500, D600
Suspension	P: Tube Suspension
Reflector	W: Snow White, V: Ivory White, S: Radiant Silver, U: Urban Graphite, B: Jet Black, H: Anodic Champagne, K: Satin Copper, G: Satin Gold



Microprismatic | Direct

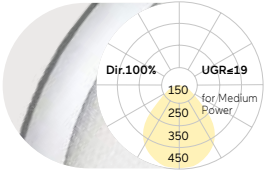

Opal Diffuser | Direct

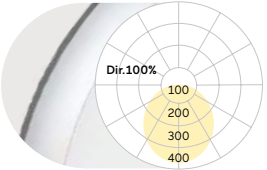

D mm	Lumen/Watt Medium Power	Lumen/Watt High Power	D mm	Lumen/Watt Medium Power	Lumen/Watt High Power
300	830lm/8W	1430lm/13W	300	810lm/8W	1400lm/13W
400	1500lm/14W	2410lm/21W	400	1500lm/14W	2410lm/21W
500	2370lm/21W	3980lm/35W	500	2390lm/21W	4040lm/35W
600	3560lm/28W	5230lm/42W	600	3650lm/28W	5330lm/42W

Lumen Values: Luminaire luminous flux at 4000K/CRI>80. Other configurations on request.

Tube Suspension Tilttable

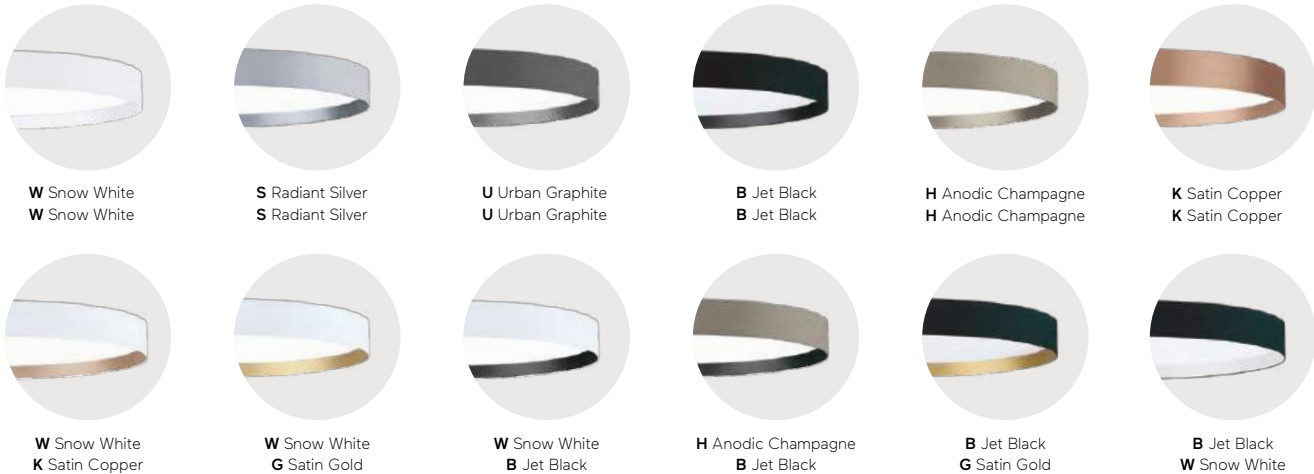
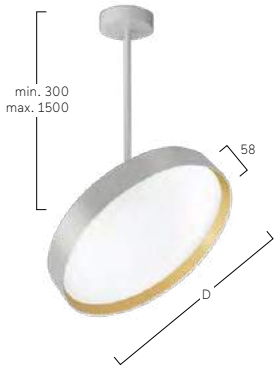

Basic Max Suspended



AIB Headquarters, Dublin, Ireland

Basic G1

Photography: Donal Murphy Photography, Planning: dlight



Basic Max G1/P1 | Suspended



DE LED-Pendelleuchte. Direkt-indirekt oder rein direktstrahlend. Leuchtenkörper aus Aluminiumprofil mit in 8 verschiedenen Durchmessern von 300 bis 2000mm – bei gleichbleibender Bauhöhe 75mm. Oberfläche weiß, silber, graphit, schwarz, champagner oder kupferfarben lackiert. Weitere Oberflächenoptionen siehe Lightnet-Surface-Collection oder RAL nach Wahl. Microprismenoptik mit optimierter Blendungsbegrenzung speziell für Office-Anwendungen (bis max. Ø1200). Opaldiffusor aus satiniertem Acrylglas. Ab Ø1500 Diffusor mit opaler Spanndiffusor für Allgemeinbeleuchtung. Konverter in Leuchtgehäuse integriert, wahlweise einfach schaltbar oder stufenlos dimmbar (DALI, Touch-Dim, Casambi). Farbtemperatur 2200K, 2700K, 3000K, 3500K, 4000K, 6500K oder Tunable White (2700-6500K). Binning initial \leq MacAdam 3. Farbwiedergabe CRI $>$ 80, CRI $>$ 90 oder Full Spectrum. Stufenlos höhenverstellbare Zentral-Seilabhangung (max. Ø1500) oder Parallel-Seilabhangung mit transparent ummantelter Zuleitung, alternativ Pendelrohrabhangung. Lackierung Baldachin und Pendelrohr passend Leuchtenkorper. Auf Anfrage: Integration von Notlichtkomponenten, Sensortechnologie.

EN LED pendant luminaire. Direct-indirect or direct-only light distribution. Luminaire body made of aluminum profile in 8 different diameters from 300mm to 2000mm – with overall height of 75mm. Surface white, silver, graphite, black, champagne or copper coated. Further surface options see Lightnet-Surface-Collection or RAL of your choice. Microprismatic screen with optimized glare reduction especially for workplaces (up to max. Ø1200). Opal diffuser made of acrylic glass. From Ø1500 diffuser with with opal stretch foil for general lighting. Driver integrated into luminaire housing, optionally switchable or dimmable (DALI, Touch-Dim, Casambi). Colour temperature 2200K, 2700K, 3000K, 3500K, 4000K, 6500K or Tunable White (2700-6500K). Binning \leq MacAdam 3. Colour rendering CRI $>$ 80, CRI $>$ 90 or Full Spectrum. Height-adjustable central cord suspension (max. Ø1500), parallel cord suspension with transparent power supply cable, or rod suspension. Colours ceiling rose and rod suspension match to luminaire body. On request: Integration of emergency lighting components, sensor technology.

B P1 O SL - 8 30 M-D300-U

Product Family	B: Basic
Type	P1: Direct-Indirect, G1: Direct only
Optical System	A: Microprismatic [D300-D1200], O: Opal Diffuser [D300-D1200], T: Opal stretch diffuser [D1500, D2000]
Surface Finish	W: Snow White, V: Ivory White, S: Radiant Silver, U: Urban Graphite, B: Jet Black, H: Anodic Champagne, K: Satin Copper
Control Gear	E: On/Off, L: DALI, H: Touch-Dim, C: Casambi, 6: DALI DT6 for TW, 8: DALI DT8 for TW
Colour Rendering	8: CRI>80, 9: CRI>90, F: Full Spectrum [except 2200K]
Colour Temperature	22: 2200K, 27: 2700K, 30: 3000K, 35: 3500K, 40: 4000K, 65: 6500K, TW: Tunable White 2700-6500K [D400-D1200]
Power	E: Low Power, M: Medium Power
Size	Luminaire Diameter in mm: D300, D400, D500, D600, D900, D1200, D1500, D2000
Suspension	P: Tube Suspension [D400-D900], K: Parallel Suspension, U: Central Suspension [D300-D1500]
On Request	Multisensor [D400-D1200], Radar Sensor, Emergency Module [D400-D2000]



Microprismatic Direct-Indirect			Microprismatic Direct			Opal Diffuser Direct-Indirect			Opal Diffuser Direct		
D mm	Lumen/Watt Low Power	Lumen/Watt Medium Power	D mm	Lumen/Watt Low Power	Lumen/Watt Medium Power	D mm	Lumen/Watt Low Power	Lumen/Watt Medium Power	D mm	Lumen/Watt Low Power	Lumen/Watt Medium Power
300	1440lm/12W	2810lm/21W	300	880lm/8W	1730lm/14W	300	1470lm/12W	2860lm/21W	300	910lm/8W	1780lm/14W
400	2800lm/19W	5740lm/40W	400	1740lm/13W	3580lm/29W	400	2850lm/19W	5850lm/40W	400	1790lm/13W	3690lm/29W
500	3970lm/29W	7760lm/53W	500	2480lm/18W	4860lm/35W	500	4040lm/29W	7910lm/53W	500	2550lm/18W	5010lm/35W
600	8370lm/55W	12900lm/87W	600	3860lm/28W	7250lm/52W	600	8490lm/55W	13120lm/87W	600	3980lm/28W	7470lm/52W
900	11330lm/88W	17110lm/144W	900	6800lm/59W	11490lm/106W	900	11530lm/88W	17450lm/144W	900	7000lm/59W	11830lm/106W
1200	18140lm/143W	28870lm/251W	1200	11890lm/107W	20110lm/195W	1200	18500lm/143W	29460lm/251W	1200	12250lm/107W	20700lm/195W
						1500	20850lm/181W	34360lm/324W	1500	17290lm/162W	28950lm/287W
						2000	35880lm/315W	59120lm/578W	2000	29860lm/284W	50000lm/526W

Lumen Values: Luminaire luminous flux at 4000K/CRI>80. Other configurations on request.

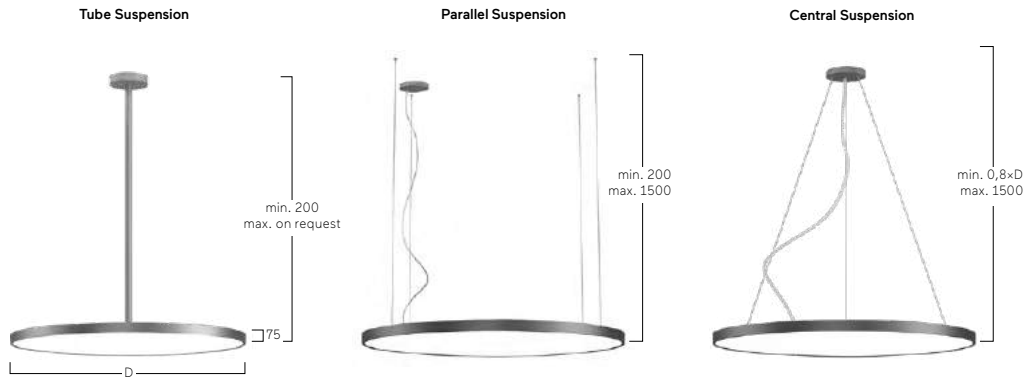

Basic Visio G9/P9 | Suspended



DE LED-Pendelleuchte. Direkt-indirekt oder direkt-rundumstrahlend. Leuchtenkörper aus gegossenem Acrylglas. Wahlweise Microprismenoptik mit optimierter Blendungsbegrenzung speziell für Office-Anwendungen oder satinierter Opaldiffusor für Allgemeinbeleuchtung mit max. Transmissionsgrad und homogener Lichtpunktauflösung. Optikträger wahlweise weiß oder graphitfarben lackiert. Konverter in Leuchtengehäuse integriert, wahlweise einfach schaltbar oder stufenlos dimmbar (DALI, Touch-Dim, Casambi). Farbtemperatur 2200K, 2700K, 3000K, 3500K, 4000K, 6500K oder Tunable White (2700-6500K). Binning initial \leq MacAdam 3. Farbwiedergabe CRI > 80, CRI > 90 oder Full Spectrum. Stufenlos höhenverstellbare Zentral-Seilabhangung mit transparent ummantelter Zuleitung oder Pendelrohrabhangung. Lackierung Baldachin und Pendelrohr passend Optiktrager. Auf Anfrage: Integration von Notlichtkomponenten.

EN LED pendant luminaire. Direct-indirect or direct omnidirectional light distribution. Luminaire body made of cast acrylic glass. Available with microprismatic screen with optimized glare reduction especially for workplaces or satin opal diffuser for general lighting with maximum transmittance and homogeneous lighting. Backplate optionally white or graphite coated. Driver integrated into luminaire housing, optionally switchable or dimmable (DALI, Touch-Dim, Casambi). Colour temperature 2200K, 2700K, 3000K, 3500K, 4000K, 6500K or Tunable White (2700-6500K). Binning \leq MacAdam 3. Colour rendering CRI > 80, CRI > 90 or Full Spectrum. Height-adjustable central cord suspension with transparent power supply cable or rod suspension. Colours ceiling rose and rod suspension match to optics carrier. On request: Integration of emergency lighting components.

B P9 O S U-8 30 M-D300-U

Product Family	B: Basic
Type	P9: Direct-Indirect, G9: Direct only
Optical System	A: Microprismatic, O: Opal Diffuser
Surface Finish	W: Snow White, U: Urban Graphite
Control Gear	E: On/Off, L: DALI, H: Touch-Dim, C: Casambi
Colour Rendering	8: CRI>80, 9: CRI>90, F: Full Spectrum [except 2200K]
Colour Temperature	22: 2200K, 27: 2700K, 30: 3000K, 35: 3500K, 40: 4000K, 65: 6500K
Power	M: Medium Power, H: High Power
Size	Luminaire Diameter in mm: D300, D400, D500, D610
Suspension	P: Tube Suspension [D400-D610], U: Central Suspension



Microprismatic | Direct-Indirect

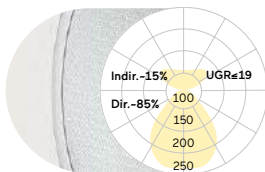

D mm	Lumen/Watt Medium Power	Lumen/Watt High Power
300	760lm/6W	1200lm/10W
400	1770lm/14W	3090lm/23W
500	2840lm/21W	5230lm/38W
610	3830lm/28W	7100lm/52W

Microprismatic | Direct

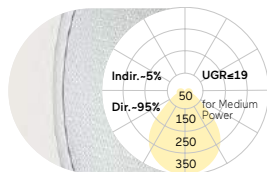

D mm	Lumen/Watt Medium Power	Lumen/Watt High Power
300	630lm/5W	1000lm/9W
400	1630lm/13W	2840lm/22W
500	2470lm/19W	4560lm/34W
610	3340lm/25W	6200lm/46W

Opal Diffuser | Direct-Indirect

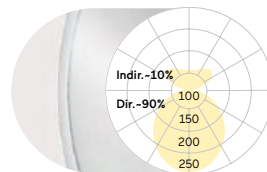

D mm	Lumen/Watt Medium Power	Lumen/Watt High Power
300	800lm/6W	1260lm/10W
400	1870lm/14W	3270lm/23W
500	2990lm/21W	5500lm/38W
610	4040lm/28W	7470lm/52W

Opal Diffuser | Direct

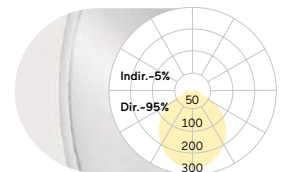

D mm	Lumen/Watt Medium Power	Lumen/Watt High Power
300	670lm/5W	1060lm/9W
400	1730lm/13W	3020lm/22W
500	2620lm/19W	4830lm/34W
610	3550lm/25W	6570lm/46W

Lumen Values: Luminaire luminous flux at 4000K/CRI>80. Other configurations on request.

Tube Suspension



Central Suspension



W Snow White



U Urban Graphite

Beam Me Up (Flat) G3/P3 | Suspended





Moynihan Train Hall, New York, USA
Beam Me Up G3



Beam Me Up (Flat) G3/P3 | Suspended



DE LED-Pendelleuchte mit rückversetzter Optik und dekorativem Reflektorring. Direkt-indirekt oder rein direktstrahlend. Leuchtschirm aus hochwertig verarbeitetem, glasfaserverstärktem Fiberglas. Gehäuse-Außenfläche und dekorativer Reflektorring in unterschiedlichen Lackierungen und Kombinationen erhältlich, z.B. weiß, silber, graphit, schwarz, gold oder kupferfarben lackiert. Zu Oberflächenoptionen- und Kombinationen siehe Lightnet-Surface-Collection oder Bi-Colour-Auswahl. Microprismenoptik mit optimierter Blendungsbegrenzung speziell für Office-Anwendungen. Satinierter Opaldiffusor für Allgemeinbeleuchtung mit max. Transmissionsgrad und homogener Lichtpunktauflösung. Konverter in Leuchtgehäuse integriert, wahlweise einfach schaltbar oder stufenlos dimmbar (DALI, Touch-Dim, Casambi). Farbtemperatur 2200K, 2700K, 3000K, 3500K, 4000K, 6500K oder Tunable White (2700-6500K). Binning initial \leq MacAdam 3. Farbwiedergabe CRI $>$ 80 oder CRI $>$ 90. Stufenlos höhenverstellbare Zentral-Seilabhangung oder Parallel-Seilabhangung mit transparent ummantelter Zuleitung, alternativ Pendelrohrabhangung. Lackierung Baldachin und Pendelrohr passend Leuchtenkorper. Auf Anfrage: Integration von Notlichtkomponenten, Sensortechnologie.

EN LED pendant luminaire with a rebated lens optic in a decorative ring. Direct-indirect or direct-only light distribution. Luminaire shade made of high-quality processed FRP (fiberglass reinforced plastic). Outer housing and Decorative reflector ring available in various finishes and combinations, e.g. white, silver, graphite, black, gold or copper coated. For further surface options see Lightnet-Surface-Collection or RAL of your choice. Microprismatic screen with optimized glare reduction especially for workplaces. Satin opal diffuser for general lighting with maximum transmittance and homogeneous lighting. Driver integrated into luminaire housing, optionally switchable or dimmable (DALI, Touch-Dim, Casambi). Colour temperature 2200K, 2700K, 3000K, 3500K, 4000K, 6500K or Tunable White (2700-6500K). Binning \leq MacAdam 3. Colour rendering CRI $>$ 80 or CRI $>$ 90. Height-adjustable central cord suspension, parallel cord suspension with transparent power supply cable, or rod suspension. Colours ceiling rose and rod suspension match to luminaire body. On request: Integration of emergency lighting components, sensor technology.

MP3 O A L-830 M-D450-UG

- Product Family **M:** Beam Me Up
- Type **G3:** Direct only, **P3:** Direct-Indirect
- Optical System **A:** Microprismatic, **O:** Opal Diffuser
- Surface Finish **W:** Snow White, **V:** Ivory White, **A:** Satin Silver, **U:** Urban Graphite, **B:** Jet Black, **H:** Anodic Champagne, **K:** Satin Copper
- Control Gear **E:** On/Off, **L:** DALI, **H:** Touch-Dim, **C:** Casambi, **6:** DALI DT6 for TW, **8:** DALI DT8 for TW
- Colour Rendering **8:** CRI>80, **9:** CRI>90, **F:** Full Spectrum [except 2200K]
- Colour Temperature **22:** 2200K, **27:** 2700K, **30:** 3000K, **35:** 3500K, **40:** 4000K, **65:** 6500K, **TW:** Tunable White 2700-6500K [D650-D850]
- Power **M:** Medium Power, **H:** High Power
- Size Luminaire Diameter in mm: **D450, D650, D850**
- Suspension **P:** Tube Suspension, **K:** Parallel Suspension, **U:** Central Suspension
- Reflector **W:** Snow White, **V:** Ivory White, **A:** Satin Silver, **U:** Urban Graphite, **B:** Jet Black, **H:** Anodic Champagne, **K:** Satin Copper, **G:** Satin Gold
- On Request Radar Sensor, Emergency Module [D650-D850]



Microprismatic | Direct-Indirect

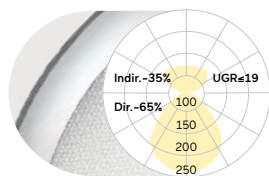

D mm	Lumen/Watt Medium Power	Lumen/Watt High Power
450	2240lm/18W	3870lm/31W
650	5020lm/40W	7720lm/63W
850	7490lm/60W	10240lm/81W

Microprismatic | Direct

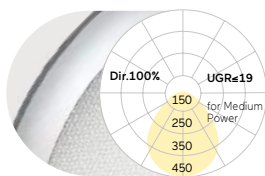

D mm	Lumen/Watt Medium Power	Lumen/Watt High Power
450	1450lm/12W	2510lm/21W
650	3200lm/25W	5200lm/42W
850	5020lm/40W	6790lm/54W

Opal Diffuser | Direct-Indirect

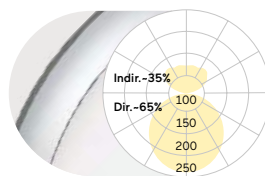

D mm	Lumen/Watt Medium Power	Lumen/Watt High Power
450	2260lm/18W	3910lm/31W
650	5120lm/40W	7890lm/63W
850	7650lm/60W	10460lm/81W

Opal Diffuser | Direct

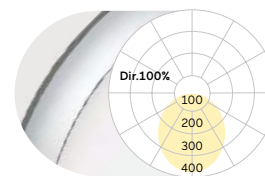

D mm	Lumen/Watt Medium Power	Lumen/Watt High Power
450	1470lm/12W	2550lm/21W
650	3300lm/25W	5370lm/42W
850	5180lm/40W	7010lm/54W

Lumen Values: Luminaire luminous flux at 4000K/CRI>80. Other configurations on request.

Tube Suspension

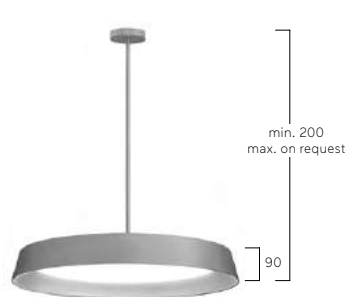

Parallel Suspension

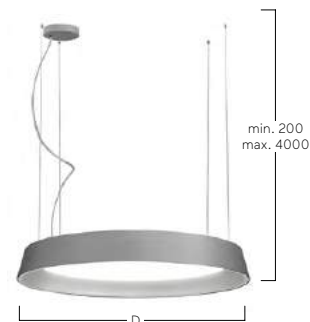

Central Suspension



H Anodic Champagne
H Anodic Champagne



U Urban Graphite
U Urban Graphite



K Satin Copper
K Satin Copper



H Anodic Champagne
B Jet Black



B Jet Black
G Satin Gold



B Jet Black
W Snow White

Beam Me Up (Max) G1/P1 | Suspended



Morgan Stanley, Glasgow, UK
Beam Me Up P1

Agras, Genoa, Italy
Beam Me Up X1



Beam Me Up (Max) G1/P1 | Suspended



DE LED-Pendelleuchte mit rückversetzter Optik und dekorativem Reflektorring. Direkt-indirekt oder rein direktstrahlend. Leuchtschirm aus hochwertig verarbeitetem, glasfaserverstärktem Fiberglas. Gehäuse-Außenfläche und dekorativer Reflektorring in unterschiedlichen Lackierungen und Kombinationen erhältlich, z.B. weiß, silber, graphit, schwarz, gold oder kupferfarben lackiert. Zu Oberflächenoptionen- und Kombinationen siehe Lightnet-Surface-Collection oder Bi-Colour-Auswahl. Microprismenoptik mit optimierter Blendungsbegrenzung speziell für Office-Anwendungen. Satinierter Opaldiffusor für Allgemeinbeleuchtung mit max. Transmissionsgrad und homogener Lichtpunktauflösung. Konverter in Leuchtgehäuse integriert, wahlweise einfach schaltbar oder stufenlos dimmbar (DALI, Touch-Dim, Casambi). Farbtemperatur 2200K, 2700K, 3000K, 3500K, 4000K, 6500K oder Tunable White (2700-6500K). Binning initial \leq MacAdam 3. Farbwiedergabe CRI>80 oder CRI>90. Stufenlos höhenverstellbare Zentral-Seilabhangung (max. \varnothing 1500) oder Parallel-Seilabhangung mit transparent ummantelter Zuleitung, alternativ Pendelrohrabhangung (D400-D700). Lackierung Baldachin und Pendelrohr passend Leuchtenkorper. Auf Anfrage: Integration von Notlichtkomponenten, Sensortechnologie.

EN LED pendant luminaire with a rebated lens optic in a decorative ring. Direct-indirect or direct-only light distribution. Luminaire shade made of high-quality processed FRP (fiberglass reinforced plastic). Outer housing and Decorative reflector ring available in various finishes and combinations, e.g. white, silver, graphite, black, gold or copper coated. For further surface options see Lightnet-Surface-Collection or RAL of your choice. Microprismatic screen with optimized glare reduction especially for workplaces. Satin opal diffuser for general lighting with maximum transmittance and homogeneous lighting. Driver integrated into luminaire housing, optionally switchable or dimmable (DALI, Touch-Dim, Casambi). Colour temperature 2200K, 2700K, 3000K, 3500K, 4000K, 6500K or Tunable White (2700-6500K). Binning \leq MacAdam 3. Colour rendering CRI>80 or CRI>90. Height-adjustable central cord suspension (max. \varnothing 1500), parallel cord suspension with transparent power supply cable, or rod suspension(D400-D700). Colours ceiling rose and rod suspension match to luminaire body. On request: Integration of emergency lighting components, sensor technology.

M P I O A L - 8 3 0 M - D 7 0 0 - U G

- Product Family **M:** Beam Me Up
- Type **P1:** Direct-Indirect, **G1:** Direct only
- Optical System **A:** Microprismatic, **O:** Opal Diffuser
- Surface Finish **W:** Snow White, **V:** Ivory White, **A:** Satin Silver, **U:** Urban Graphite, **B:** Jet Black, **H:** Anodic Champagne, **K:** Satin Copper
- Control Gear **E:** On/Off, **L:** DALI, **H:** Touch-Dim, **C:** Casambi, **6:** DALI DT6 for TW, **8:** DALI DT8 for TW
- Colour Rendering **8:** CRI>80, **9:** CRI>90, **F:** Full Spectrum [except 2200K]
- Colour Temperature **22:** 2200K, **27:** 2700K, **30:** 3000K, **35:** 3500K, **40:** 4000K, **65:** 6500K, **TW:** Tunable White 2700-6500K
- Power **M:** Medium Power, **H:** High Power
- Size Luminaire Diameter in mm: **D400, D700, D1200**
- Suspension **U:** Central Suspension, **P:** Tube Suspension [D400- D700], **K:** Parallel Suspension
- Reflector **W:** Snow White, **V:** Ivory White, **A:** Satin Silver, **U:** Urban Graphite, **B:** Jet Black, **H:** Anodic Champagne, **K:** Satin Copper, **G:** Satin Gold
- On Request Radar Sensor, Emergency Module



Microprismatic | Direct-Indirect

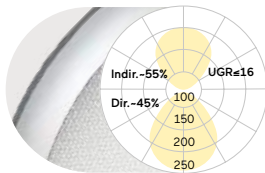

D mm	Lumen/Watt Medium Power	Lumen/Watt High Power
400	2180lm/20W	3190lm/32W
700	5860lm/50W	8590lm/80W
1200	19730lm/177W	27150lm/247W

Microprismatic | Direct

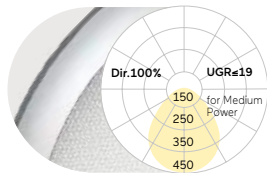

D mm	Lumen/Watt Medium Power	Lumen/Watt High Power
400	1090lm/14W	1600lm/22W
700	2920lm/35W	4290lm/52W
1200	8580lm/104W	11220lm/139W

Opal Diffuser | Direct-Indirect

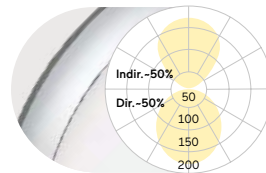

D mm	Lumen/Watt Medium Power	Lumen/Watt High Power
400	2230lm/20W	3270lm/32W
700	6000lm/50W	8790lm/80W
1200	20130lm/177W	27680lm/247W

Opal Diffuser | Direct

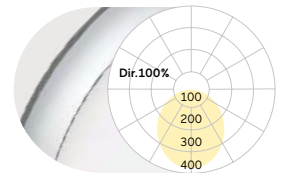

D mm	Lumen/Watt Medium Power	Lumen/Watt High Power
400	1140lm/14W	1680lm/22W
700	3060lm/35W	4490lm/52W
1200	8980lm/104W	11750lm/139W

Lumen Values: Luminaire luminous flux at 4000K/CRI>80. Other configurations on request.

Tube Suspension



Parallel Suspension

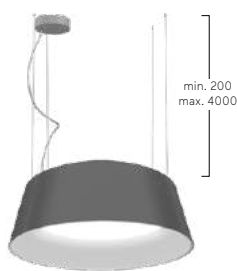

Central Suspension



H Anodic Champagne
H Anodic Champagne



U Urban Graphite
U Urban Graphite



K Satin Copper
K Satin Copper



H Anodic Champagne
B Jet Black

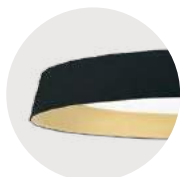

B Jet Black
G Satin Gold



B Jet Black
W Snow White

Ringo Star Compact G5/P5 | Suspended



DE LED-Pendelleuchte. Direkt-indirekt oder rein direktstrahlend. Leuchtenkörper aus Aluminiumprofil mit 40mm Profildbreite. Kompakte Ausführung mit innenliegendem Blindelement. 3 verschiedene Durchmesser (Ø200, Ø270, Ø370). Oberfläche weiß, silber, graphit, schwarz, champagner oder kupferfarben lackiert. Weitere Oberflächenoptionen siehe Lightnet-Surface-Collection oder RAL nach Wahl. Direktanteil über Präzisionslinsen mit Abblenderaster für breite rotationssymmetrische Lichtstärkeverteilung bei gleichzeitig hoher Blendungsbegrenzung (UGR<19) speziell für Office Anwendungen. Abblenderaster in verschiedenen Farbkombinationen erhältlich. Konverter im zentralen Blindelement integriert, wahlweise einfach schaltbar oder stufenlos dimmbar (DALI, Touch-Dim). Farbtemperatur 2200K, 2700K, 3000K, 3500K, 4000K oder 6500K. Binning initial \leq MacAdam 3. Farbwiedergabe CRI>80, CRI>90 oder Full Spectrum. Stufenlos höhenverstellbare Zentral-Seilabhängung mit transparent ummantelter Zuleitung oder Pendelrohrabhängung. Auf Anfrage: Integration von Sensortechnologie, Lüftungsauslässen, Lautsprechern, Überwachungskameras und zusätzlichen Downlights im zentralen Blindelement.

EN LED pendant luminaire. Direct-indirect or direct-only light distribution. Luminaire body made of aluminium profile with 40mm profile width. Compact version with internal blind element. 3 different diameters (Ø200, Ø270, Ø370). Surface white, silver, graphite, black, champagne or copper coated. For further surface options see Lightnet-Surface-Collection or RAL of your choice. Direct light using precision lenses with louvre for wide uniform symmetrical light distribution with high glare limitation (UGR<19) especially for workplaces. Louvre available in various colour finishes. Driver integrated into central blind element, optionally switchable or dimmable (DALI, Touch-Dim). Colour temperature 2200K, 2700K, 3000K, 3500K, 4000K or 6500K. Binning \leq MacAdam 3. Colour rendering CRI>80, CRI>90 or Full Spectrum. Height-adjustable central cord suspension with transparent power supply cable or rod suspension. On request: Integration of sensor technology, ventilation outlets, loudspeakers, surveillance cameras and additional downlights in the central blind element.

R P5 LWE-8 30 E-D270-UW-MP

Product Family	R: Ringo Star
Type	G5: Direct only, P5: Direct-Indirect [D270-D370]
Optical System	L: Lens Louvre
Surface Finish	W: Snow White, V: Ivory White, A: Satin Silver, S: Radiant Silver, U: Urban Graphite, B: Jet Black, H: Anodic Champagne, K: Satin Copper
Control Gear	E: On/Off, L: DALI, H: Touch-Dim
Colour Rendering	8: CRI>80, 9: CRI>90, F: Full Spectrum [except 2200K]
Colour Temperature	22: 2200K, 27: 2700K, 30: 3000K, 35: 3500K, 40: 4000K, 65: 6500K
Power	E: Low Power, H: High Power
Size	Luminaire Length in mm: D200, D270, D370
Suspension	U: Central Suspension, P: Tube Suspension
Reflector	W: Snow White, A: Satin Silver, B: Jet Black, H: Anodic Champagne, K: Satin Copper, G: Satin Gold
Central Module	For D200: BP: Blind Plate, EM: Emergency Module***, MM: Multisensor*** For D270: BP: Blind Plate, EM: Emergency Module***, MM: Multisensor*** For D370: BP: Blind Plate, EM: Emergency Module***, MM: Multisensor***
On Request	Casambi, Camera

* Please specify type ** With external drivers



Lens Louvre | Direct-Indirect

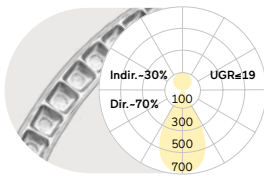

Lens Louvre | Direct

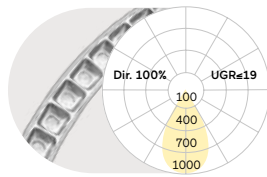

D mm	Lumen/Watt		D mm	Lumen/Watt	
	Low Power	High Power		Low Power	High Power
270	2610lm/19W	4390lm/34W	200	1570lm/13W	2660lm/23W
370	3430lm/27W	5800lm/46W	270	1860lm/15W	3110lm/26W
			370	2480lm/20W	4140lm/34W

Lumen Values: Luminaire luminous flux at 4000K/CRI>80. Other configurations on request.

Tube Suspension



Central Suspension



BP Blind Plate



EM Emergency Module



MM Multisensor



Camera

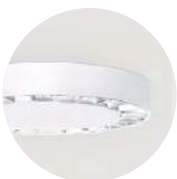

W Snow White
W Snow White



W Snow White
A Satin Silver



W Snow White
B Jet Black



W Snow White
G Satin Gold



W Snow White
H Anodic Champagne



W Snow White
K Satin Copper

Ringo Star GY/PY | System 40mm Suspended



DE LED-Pendelleuchte. Direkt-indirekt oder rein direktstrahlend. Leuchtenkörper aus Aluminiumprofil mit 40mm Profildbreite. 6 verschiedene Durchmesser von 600mm bis 2500mm. Oberfläche weiß, silber, graphit, schwarz, champagner oder kupferfarben lackiert. Weitere Oberflächenoptionen siehe Lightnet-Surface-Collection oder RAL nach Wahl. Direktanteil über Präzisionslinsen mit Abblenderaster (Ø600-Ø1245) für breite rotationssymmetrische Lichtstärkeverteilung bei gleichzeitig hoher Blendungsbegrenzung (UGR<19) speziell für Office Anwendungen. Abblenderaster in verschiedenen Farbkombinationen erhältlich. Satinierter Opaldiffusor für Allgemeinbeleuchtung mit max. Transmissionsgrad und homogener Lichtpunktauflösung. Konverter im Deckenbaldachin integriert, wahlweise einfach schaltbar oder stufenlos dimmbar (DALI, Touch-Dim). Farbtemperatur 2200K, 2700K, 3000K, 3500K, 4000K oder 6500K. Binning initial \leq MacAdam 3. Farbwiedergabe CRI>80, CRI>90 oder Full Spectrum. Stufenlos höhenverstellbare Zentral-Seilabhängung oder Parallel-Seilabhängung mit transparent ummantelter Zuleitung. Lackierung Baldachin passend Leuchtenkörper.

EN LED pendant luminaire. Direct-indirect or direct-only light distribution. Luminaire body made of aluminium profile with 40mm profile width. 6 different diameters from 600mm to 2500mm. Surface white, silver, graphite, black, champagne or copper coated. Further surface options see Lightnet-Surface-Collection or RAL of your choice. Direct light using precision lenses with louvre (Ø600-Ø1245) for wide uniform symmetrical light distribution with high glare limitation (UGR<19) especially for workplaces. Louvre available in various colour finishes. Satin opal diffuser for general lighting with maximum transmittance and homogeneous lighting. Driver integrated into ceiling rose, optionally switchable or dimmable (DALI, Touch-Dim). Colour temperature 2200K, 2700K, 3000K, 3500K, 4000K or 6500K. Binning \leq MacAdam 3. Colour rendering CRI>80, CRI>90 or Full Spectrum. Height-adjustable central cord suspension or parallel cord suspension with transparent power supply cable. Colours ceiling rose match to luminaire body.

R P Y L W E - 8 3 0 M - D 6 0 0 - K B *

Product Family	R: Ringo Star
Type	PY: Direct-Indirect, GY: Direct only; LED converter in suspension box
Optical System	C: Opal Flex Diffuser, L: Lens Louvre* [D600-D1245]
Surface Finish	W: Snow White, V: Ivory White, A: Satin Silver, S: Radiant Silver, U: Urban Graphite, B: Jet Black, H: Anodic Champagne, K: Satin Copper
Control Gear	E: On/Off, L: DALI, C: Casambi, H: Touch-Dim
Colour Rendering	8: CRI>80, 9: CRI>90, F: Full Spectrum [except 2200K]
Colour Temperature	22: 2200K, 27: 2700K, 30: 3000K, 35: 3500K, 40: 4000K, 65: 6500K
Power	M: Medium Power
Size	Luminaire Diameter in mm: D600, D900, D1245, D1500, D2000, D2500
Suspension	U: Central Suspension [D600-D2000], K: Parallel Suspension, X: Parallel Suspension with Recessed Ceiling Rose
Lens Louvre*	W: Snow White, A: Satin Silver, B: Jet Black, H: Anodic Champagne, K: Satin Copper, G: Satin Gold

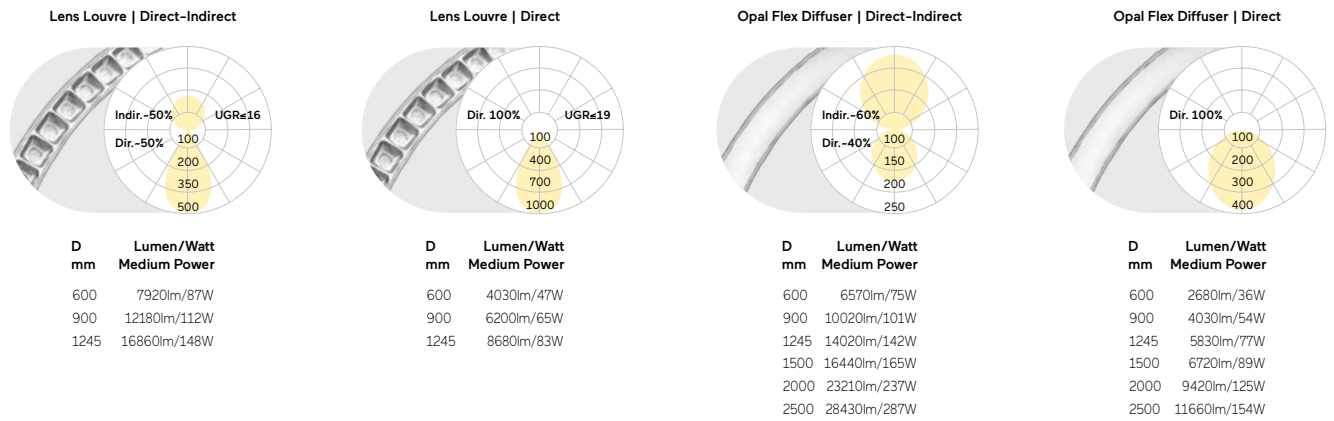

Lumen Values: Luminaire luminous flux at 4000K/CRI>80. Other configurations on request.

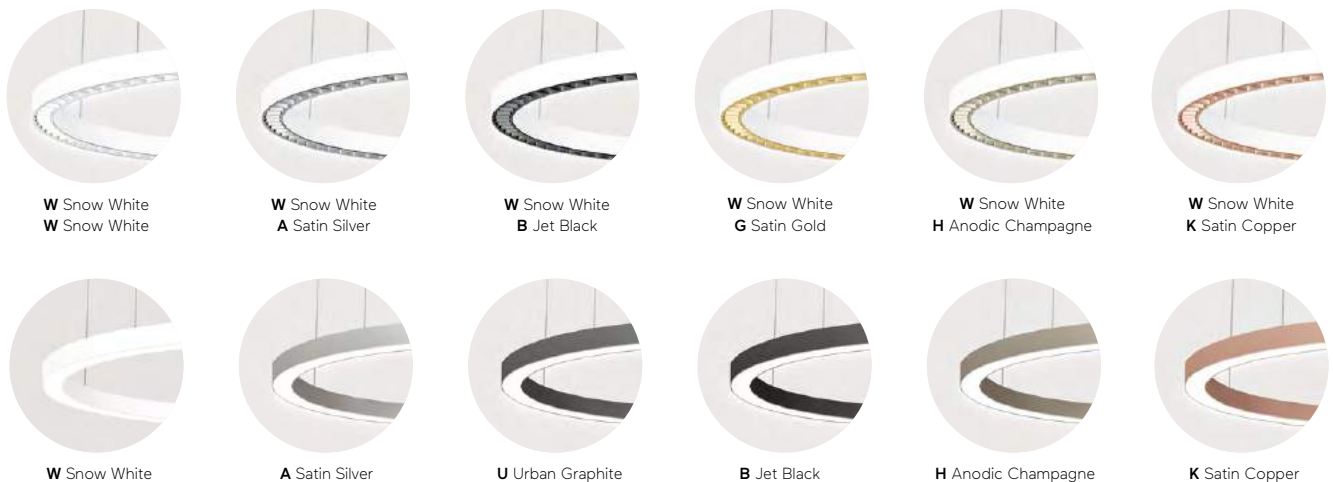

Ringo Star GX/PX | System 40mm Suspended



DE LED-Pendelleuchte. Direkt-indirekt oder rein direktstrahlend. Leuchtenkörper aus Aluminiumprofil mit 40mm Profildbreite. 6 verschiedene Durchmesser von 600mm bis 2500mm. Oberfläche weiß, silber, graphit, schwarz, champagner oder kupferfarben lackiert. Weitere Oberflächenoptionen siehe Lightnet-Surface-Collection oder RAL nach Wahl. Direktanteil über Präzisionslinsen mit Abblendraster (Ø600-Ø1245) für breite rotationssymmetrische Lichtstärkeverteilung bei gleichzeitig hoher Blendungsbegrenzung (UGR<19) speziell für Office Anwendungen. Abblendraster in verschiedenen Farbkombinationen erhältlich. Satinierter Opaldiffusor für Allgemeinbeleuchtung mit max. Transmissionsgrad und homogener Lichtpunktauflösung. Konverter in Leuchtengehäuse integriert, wahlweise einfach schaltbar oder stufenlos dimmbar (DALI, Touch-Dim, Casambi). Farbtemperatur 2200K, 2700K, 3000K, 3500K, 4000K oder 6500K. Binning initial ≤ MacAdam 3. Farbwiedergabe CRI>80, CRI>90 oder Full Spectrum. Stufenlos höhenverstellbare Zentral-, Parallel- oder Disc-Seilabhängung mit transparent ummantelter Zuleitung. Lackierung Baldachin passend Leuchtenkörper.

EN LED pendant luminaire. Direct-indirect or direct-only light distribution. Luminaire body made of aluminium profile with 40mm profile width. 6 different diameters from 600mm to 2500mm. Surface white, silver, graphite, black, champagne or copper coated. For further surface options see Lightnet-Surface-Collection or RAL of your choice. Direct light using precision lenses with louvre (Ø600-Ø1245) for wide uniform symmetrical light distribution with high glare limitation (UGR<19) especially for workplaces. Louvre available in various colour finishes. Satin opal diffuser for general lighting with maximum transmittance and homogeneous lighting. Driver integrated into luminaire housing, optionally switchable or dimmable (DALI, Touch-Dim, Casambi). Colour temperature 2200K, 2700K, 3000K, 3500K, 4000K or 6500K. Binning ≤ MacAdam 3. Colour rendering CRI>80, CRI>90 or Full Spectrum. Height-adjustable central, parallel or disc cord suspension with transparent power supply cable. Colours ceiling rose match to luminaire body.

RPXLWE-830E-D600-KB*

Product Family	R: Ringo Star
Type	PX: Direct-Indirect, GX: Direct only
Optical System	C: Opal Flex Diffuser, L: Lens Louvre* [D600-D1245]
Surface Finish	W: Snow White, V: Ivory White, A: Satin Silver, S: Radiant Silver, U: Urban Graphite, B: Jet Black, H: Anodic Champagne, K: Satin Copper
Control Gear	E: On/Off, L: DALI, C: Casambi, H: Touch-Dim
Colour Rendering	8: CRI>80, 9: CRI>90, F: Full Spectrum [except 2200K]
Colour Temperature	22: 2200K, 27: 2700K, 30: 3000K, 35: 3500K, 40: 4000K, 65: 6500K
Power	E: Low Power, M: Medium Power, H: High Power
Size	Luminaire Diameter in mm: D600, D900, D1245, D1500, D2000, D2500
Suspension	U: Central Suspension [D600-D2000], K: Parallel Suspension, D: Disc Suspension
Lens Louvre*	W: Snow White, A: Satin Silver, B: Jet Black, H: Anodic Champagne, K: Satin Copper, G: Satin Gold
On Request	Midpin Spotlights



Lens Louvre Direct-Indirect			Lens Louvre Direct			Opal Flex Diffuser Direct-Indirect			Opal Flex Diffuser Direct		
D mm	Lumen/Watt Low Power	Lumen/Watt Medium Power	D mm	Lumen/Watt Low Power	Lumen/Watt High Power	D mm	Lumen/Watt Low Power	Lumen/Watt Medium Power	D mm	Lumen/Watt Medium Power	Lumen/Watt High Power
600	5420lm/43W	7590lm/61W	600	2850lm/23W	5170lm/42W	600	4500lm/41W	6240lm/58W	600	2680lm/29W	3740lm/41W
900	8280lm/63W	11550lm/90W	900	4350lm/33W	7980lm/66W	900	6820lm/60W	9380lm/85W	900	4030lm/43W	5610lm/62W
1245	11520lm/88W	16300lm/131W	1245	6090lm/45W	11170lm/90W	1245	9510lm/88W	13440lm/124W	1245	5820lm/62W	7940lm/89W
						1500	11680lm/105W	15930lm/145W	1500	6730lm/71W	9920lm/108W
						2000	15670lm/141W	21820lm/200W	2000	9400lm/100W	13210lm/144W
						2500	19440lm/176W	27120lm/249W	2500	11630lm/125W	16700lm/182W

Lumen Values: Luminaire luminous flux at 4000K/CRI>80. Other configurations on request.

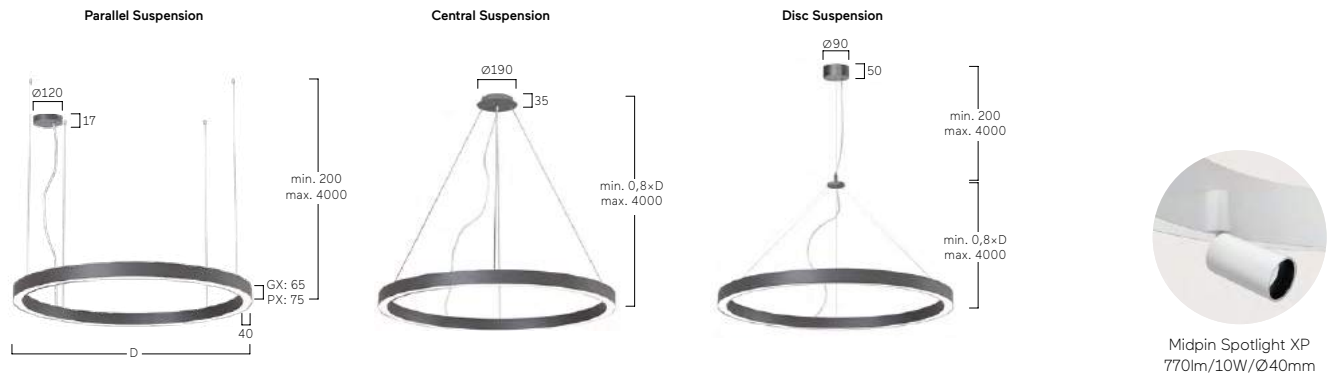

Ringo Star Acoustic GY/PY | System 40mm Suspended



DE LED-Akustikleuchte für Pendelmontage. Direkt-indirekt oder rein direktstrahlend. Leuchtenkörper aus Aluminiumprofil mit 40mm Profildicke. 5 verschiedene Durchmesser von 600mm bis 2000mm. Oberfläche weiß, silber, graphit, schwarz, champagner oder kupferfarben lackiert. Weitere Oberflächenoptionen siehe Lightnet-Surface-Collection oder RAL nach Wahl. Innenliegender Schallabsorber für breites Frequenzspektrum zur Reduktion der Nachhallzeit sowie ein angenehmes Raumklima aus Schafschurwolle aus ökologischer Haltung. Raumseitige Kaschierung aus Schurwolle in verschiedenen Farben, aus mikroperforiertem Stahl in Leuchtenfarbe lackiert oder aus grünem Moos. Direktanteil über Präzisionslinsen mit Abblendraster (Ø600-Ø1245) für breite rotationssymmetrische Lichtstärkeverteilung bei gleichzeitig hoher Blendungsbegrenzung (UGR<19) speziell für Office Anwendungen. Abblendraster in verschiedenen Farbkombinationen erhältlich. Satinierter Opaldiffusor für Allgemeinbeleuchtung mit max. Transmissionsgrad und homogener Lichtpunktauflösung. Konverter im Leuchtengehäuse integriert, wahlweise einfach schaltbar oder stufenlos dimmbar (DALI, Touch-Dim, Casambi). Farbtemperatur 2200K, 2700K, 3000K, 3500K, 4000K oder 6500K. Binning initial \leq MacAdam 3. Farbwiedergabe CRI>80, CRI>90 oder Full Spectrum. Stufenlos höhenverstellbare Zentral-Seilabhangung oder Parallel-Seilabhangung mit transparent ummantelter Zuleitung. Lackierung Baldachin passend Leuchtenkörper.

EN LED acoustic pendant luminaire. Direct-indirect or direct-only light distribution. Luminaire body made of aluminium profile with 40mm profile width. 5 different diameters from 600mm to 2000mm. Surface white, silver, graphite, black, champagne or copper coated. Further surface options see Lightnet-Surface-Collection or RAL of your choice. Internal sound absorber for a wide frequency spectrum, to reduce the reverberation time. Acoustic insert is available in various colours of ecologically reared sheep's wool, microperforated steel to match the luminaire or green moss. Direct light using precision lenses with louvre (Ø600-Ø1245) for wide uniform symmetrical light distribution with high glare limitation (UGR<19) especially for workplaces. Louvre available in various colour finishes. Satin opal diffuser for general lighting with maximum transmittance and homogeneous lighting. Driver integrated into luminaire housing, optionally switchable or dimmable (DALI, Touch-Dim, Casambi). Colour temperature 2200K, 2700K, 3000K, 3500K, 4000K or 6500K. Binning \leq MacAdam 3. Colour rendering CRI>80, CRI>90 or Full Spectrum. Height-adjustable central cord suspension or parallel cord suspension with transparent power supply cable. Colours ceiling rose match to luminaire body.

R PYL WE-8 30 M-D600-KB*-BW

Product Family	R: Ringo Star
Type	PY: Direct-Indirect, GY: Direct only
Optical System	C: Opal Flex Diffuser, L: Lens Louvre*
Surface Finish	W: Snow White, V: Ivory White, A: Satin Silver, S: Radiant Silver, U: Urban Graphite, B: Jet Black, H: Anodic Champagne, K: Satin Copper
Control Gear	E: On/Off, L: DALI, C: Casambi, H: Touch-Dim
Colour Rendering	8: CRI>80, 9: CRI>90, F: Full Spectrum [except 2200K]
Colour Temperature	22: 2200K, 27: 2700K, 30: 3000K, 35: 3500K, 40: 4000K, 65: 6500K
Power	M: Medium Power
Size	Luminaire Diameter in mm: D600, D900, D1245
Suspension	K: Parallel Suspension
Lens Louvre*	W: Snow White, A: Satin Silver, B: Jet Black, H: Anodic Champagne, K: Satin Copper, G: Satin Gold
Acoustic Absorb.	AW: Micro Perforated, BW: Beige Wool, ZW: Green Wool, GW: Graphite Wool, AM: Green Moss



Lens Louvre | Direct-Indirect

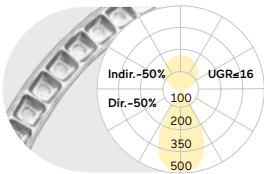

D mm	Lumen/Watt Medium Power
600	7920lm/87W
900	12180lm/112W
1245	16860lm/148W

Lens Louvre | Direct

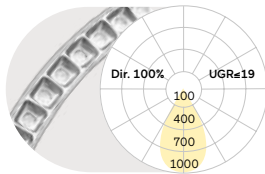

D mm	Lumen/Watt Medium Power
600	4030lm/47W
900	6200lm/65W
1245	8680lm/83W

Opal Flex Diffuser | Direct-Indirect

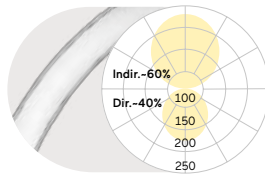

D mm	Lumen/Watt Medium Power
600	6570lm/75W
900	10020lm/101W
1245	14020lm/142W

Opal Flex Diffuser | Direct

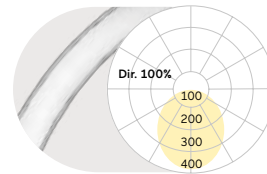

D mm	Lumen/Watt Medium Power
600	2680lm/36W
900	4030lm/54W
1245	5830lm/77W

Lumen Values: Luminaire luminous flux at 4000K/CRI>80. Other configurations on request.

Parallel Suspension



AW Micro Perforated

AM Green Moss



BW Beige Wool

ZW Green Wool

GW Graphite Wool



W Snow White
W Snow White

W Snow White
A Satin Silver

W Snow White
B Jet Black

W Snow White
G Satin Gold

W Snow White
H Anodic Champagne

W Snow White
K Satin Copper

W Snow White

A Satin Silver

U Urban Graphite

B Jet Black

H Anodic Champagne

K Satin Copper

Ringo Star Suspended



DB Training Centre, Cologne, Germany Ringo
Star P1
Photography: Tomas Rodriguez



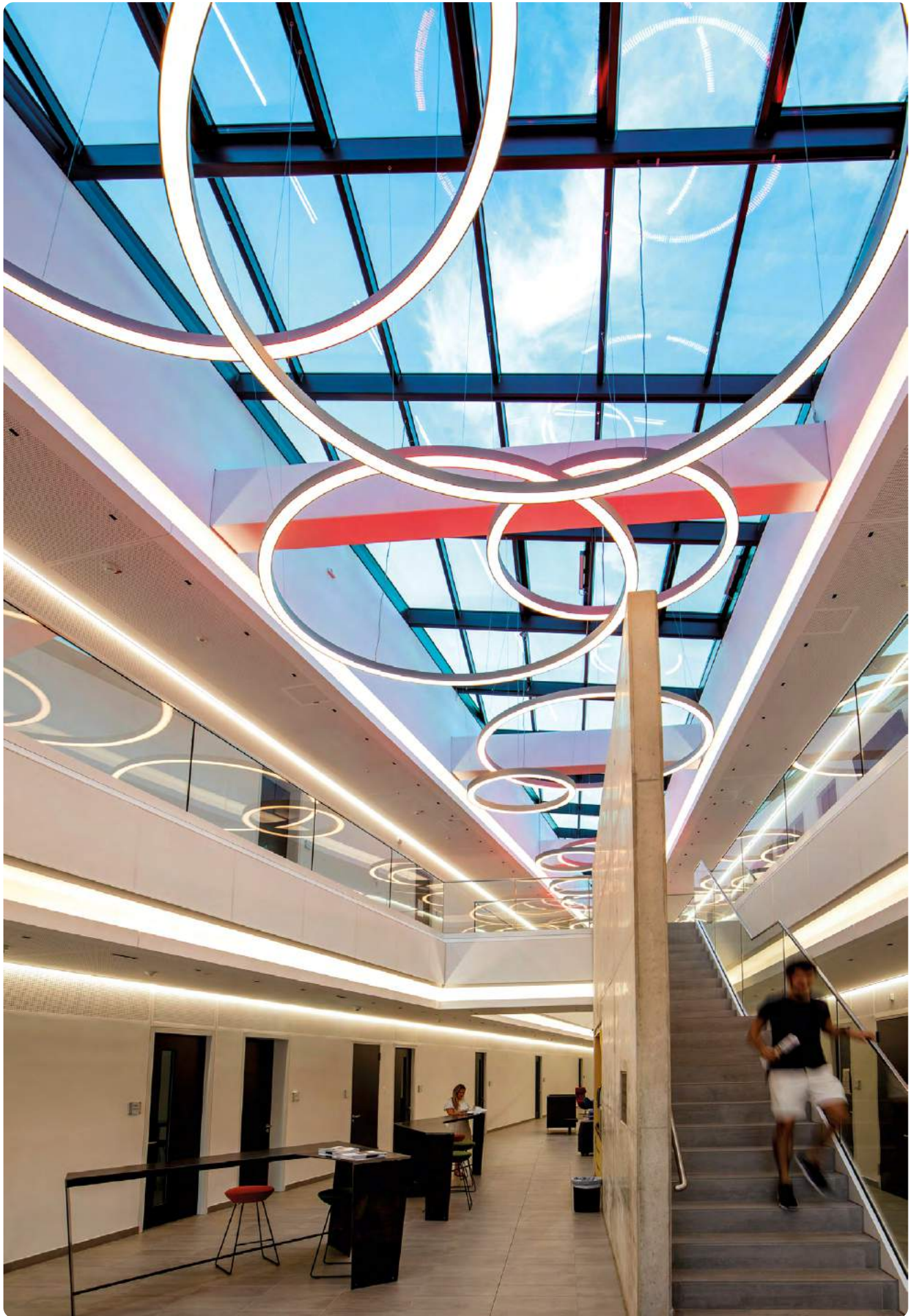

Ringo Star Suspended



Schauinslandreisen, Duisburg, Germany
Ringo Star P1
Photography: Sascha Domke



Optician Renken, Bielefeld, Germany
Ringo Star P1
Interior design: Nadia Pavan, Candela Licht + Technik
Realization and photography: Scharon Lichtkonzepte GmbH

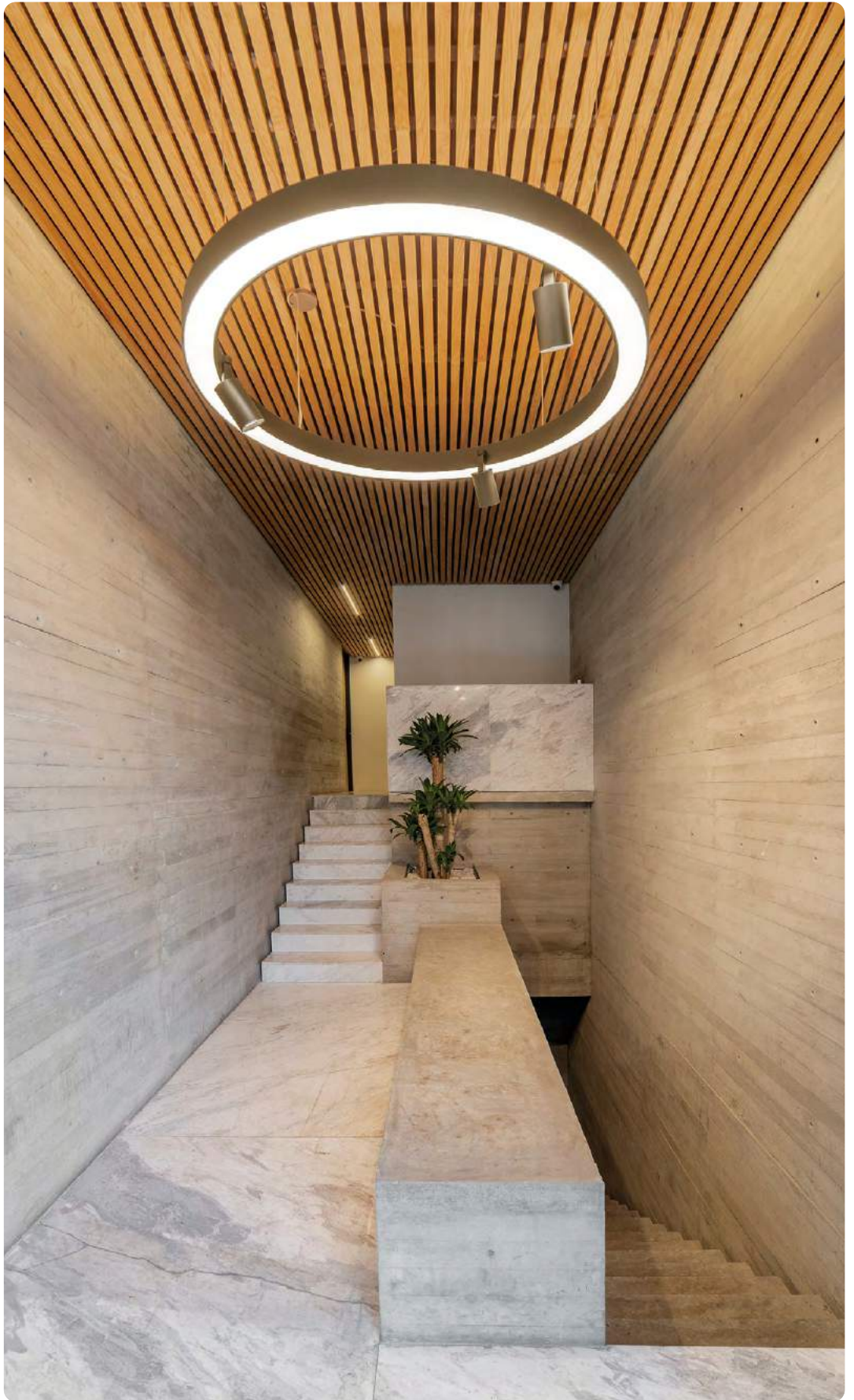

Private Residence Beistegui, Mexico City, Mexico
Ringo Star + Midpoint

Ringo Star Suspended





Fürstenhof, Bad Eilsen, Germany
Ringo Star P1



Ringo Star G3/P3 | System 60mm Suspended



DE LED-Pendelleuchte. Direkt-indirekt oder rein direktstrahlend. Leuchtenkörper aus Aluminiumprofil mit 60mm Profillbreite. 13 verschiedene Durchmesser von 600mm bis 8000mm. Oberfläche weiß, silber, graphit, schwarz, champagner oder kupferfarben lackiert. Weitere Oberflächenoptionen siehe Lightnet-Surface-Collection oder RAL nach Wahl. Microprismenoptik mit optimierter Blendungsbegrenzung speziell für Office-Anwendungen. Satiniertes Opaldiffusor für Allgemeinbeleuchtung mit max. Transmissionsgrad und homogener Lichtpunktauflösung. Konverter in Leuchtengehäuse integriert, wahlweise einfach schaltbar oder stufenlos dimmbar (DALI, Touch-Dim, Casambi). Farbtemperatur 2200K, 2700K, 3000K, 3500K, 4000K, 6500K oder Tunable White (2700-6500K). Binning initial \leq MacAdam 3. Farbwiedergabe CRI $>$ 80, CRI $>$ 90 oder Full Spectrum. Stufenlos höhenverstellbare Zentral-, Parallel- oder Disc-Seilabhängung mit transparent ummantelter Zuleitung. Lackierung Baldachin passend Leuchtenkörper.

EN LED pendant luminaire. Direct-indirect or direct-only light distribution. Luminaire body made of 60mm wide aluminium profile. 13 different diameters from 600mm to 8000mm. Surface white, silver, graphite, black, champagne or copper coated. For further surface options see Lightnet-Surface-Collection or RAL of your choice. Microprismatic screen with optimized glare reduction especially for workplaces. Satin opal diffuser for general lighting with maximum transmittance and homogeneous lighting. Driver integrated into luminaire housing, optionally switchable or dimmable (DALI, Touch-Dim, Casambi). Colour temperature 2200K, 2700K, 3000K, 3500K, 4000K, 6500K or Tunable White (2700-6500K). Binning \leq MacAdam 3. Colour rendering CRI $>$ 80, CRI $>$ 90 or Full Spectrum. Height-adjustable central, parallel or disc cord suspension with transparent power supply cable. Colours ceiling rose match to luminaire body.

R P3 O S L - 8 30 H-D1500-U

Product Family	R: Ringo Star
Type	P3: Direct-Indirect, G3: Direct only
Optical System	A: Microprismatic, O: Opal Diffuser
Surface Finish	W: Snow White, V: Ivory White, S: Radiant Silver, U: Urban Graphite, B: Jet Black, H: Anodic Champagne, K: Satin Copper
Control Gear	E: On/Off, L: DALI, H: Touch-Dim, C: Casambi, U: Separately Dimmable DALI, 6: DALI DT6 for TW, 8: DALI DT8 for TW
Colour Rendering	8: CRI>80, 9: CRI>90, F: Full Spectrum [except 2200K]
Colour Temperature	22: 2200K, 27: 2700K, 30: 3000K, 35: 3500K, 40: 4000K, 65: 6500K, TW: Tunable White 2700-6500K [D1500-D8000]
Power	M: Medium Power, H: High Power
Size	Luminaire Diameter in mm: D600, D900, D1200, D1500, D2000, D2500, D3000, D3500, D4000, D5000, D6000, D7000, D8000
Suspension	K: Parallel Suspension, U: Central Suspension [D600-D2000], D: Disc Suspension [D600-D2000]
On Request	Emergency Module [D1500-D8000], Midpin Spotlights



Microprismatic | Direct-Indirect

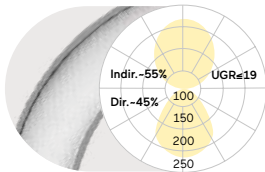

D mm	Lumen/Watt Medium Power
600	6710lm/62W
900	10690lm/99W
1200	13980lm/134W
1500	18860lm/175W
2000	24930lm/239W
2500	26660lm/263W
3000	32410lm/317W
3500	40810lm/397W
4000	43800lm/435W
5000	55690lm/539W
6000	64820lm/635W
7000	74240lm/718W
8000	91060lm/897W

Microprismatic | Direct

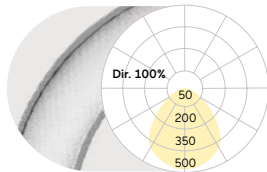

D mm	Lumen/Watt Medium Power	Lumen/Watt High Power
600	2920lm/37W	3960lm/53W
900	4650lm/59W	6030lm/80W
1200	6080lm/81W	8360lm/121W
1500	8220lm/106W	10700lm/143W
2000	10730lm/142W	14230lm/203W
2500	13360lm/173W	17390lm/237W
3000	16450lm/211W	21400lm/287W
3500	19530lm/259W	25420lm/352W
4000	22520lm/297W	29270lm/405W
5000	27760lm/356W	36120lm/479W
6000	32900lm/423W	42810lm/574W
7000	37000lm/474W	48160lm/638W
8000	43180lm/568W	56190lm/774W

Opal Diffuser | Direct-Indirect

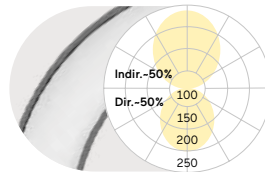

D mm	Lumen/Watt Medium Power
600	6960lm/62W
900	11090lm/99W
1200	14500lm/134W
1500	19560lm/175W
2000	25850lm/239W
2500	27800lm/263W
3000	33810lm/317W
3500	42480lm/397W
4000	45720lm/435W
5000	58050lm/539W
6000	67620lm/635W
7000	77400lm/718W
8000	94730lm/897W

Opal Diffuser | Direct

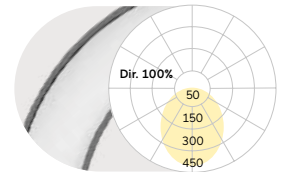

D mm	Lumen/Watt Medium Power	Lumen/Watt High Power
600	3170lm/37W	4300lm/53W
900	5050lm/59W	6540lm/80W
1200	6600lm/81W	9080lm/121W
1500	8920lm/106W	11610lm/143W
2000	11650lm/142W	15450lm/203W
2500	14500lm/173W	18870lm/237W
3000	17850lm/211W	23230lm/287W
3500	21200lm/259W	27580lm/352W
4000	24440lm/297W	31760lm/405W
5000	30120lm/356W	39200lm/479W
6000	35700lm/423W	46450lm/574W
7000	40160lm/474W	52260lm/638W
8000	46850lm/568W	60970lm/774W

Lumen Values: Luminaire luminous flux at 4000K/CRI>80. Other configurations on request.

Parallel Suspension



Central Suspension



Disc Suspension



Midpin Spotlight XP
770lm/10W/Ø40mm

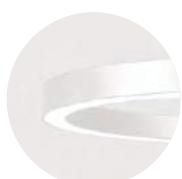

W Snow White



S Radiant Silver



U Urban Graphite



B Jet Black



H Anodic Champagne



K Satin Copper

Ringo Star Acoustic G3/P3 | System 60mm Suspended



DE LED-Akustikleuchte für Pendelmontage. Direkt-indirekt oder rein direktstrahlend. Leuchtenkörper aus Aluminiumprofil mit 60mm Profildbreite. 5 verschiedene Durchmesser von 600mm bis 2000mm. Oberfläche weiß, silber, graphit, schwarz, champagner oder kupferfarben lackiert. Weitere Oberflächenoptionen siehe Lightnet-Surface-Collection oder RAL nach Wahl. Innenliegender Schallabsorber für breites Frequenzspektrum zur Reduktion der Nachhallzeit sowie ein angenehmes Raumklima aus Schafschurwolle aus ökologischer Haltung. Raumseitige Kaschierung wahlweise aus Schurwolle in verschiedenen Farben, aus mikroperforiertem Stahl in Leuchtenfarbe lackiert oder aus grünem Moos. Microprismenoptik mit optimierter Blendungsbegrenzung speziell für Office-Anwendungen. Satinierter Opaldiffusor für Allgemeinbeleuchtung mit max. Transmissionsgrad und homogener Lichtpunktauflösung. Konverter in Leuchtengehäuse integriert, wahlweise einfach schaltbar oder stufenlos dimmbar (DALI, Touch-Dim, Casambi). Farbtemperatur 2200K, 2700K, 3000K, 3500K, 4000K, 6500K oder Tunable White (2700-6500K). Binning initial \leq MacAdam 3. Farbwiedergabe CRI>80, CRI>90 oder Full Spectrum. Stufenlos höhenverstellbare Zentral-Seilabhängung oder Parallel-Seilabhängung mit transparenter ummantelter Zuleitung. Lackierung Baldachin passend Leuchtenkörper.

EN LED acoustic pendant luminaire. Direct-indirect or direct-only light distribution. Luminaire body made of aluminium profile with 60mm profile width. 5 different diameters from 600mm to 2000mm. Surface white, silver, graphite, black, champagne or copper coated. Further surface options see Lightnet-Surface-Collection or RAL of your choice. Internal sound absorber for a wide frequency spectrum, to reduce the reverberation time. Acoustic insert is available in various colours of ecologically reared sheep's wool, microperforated steel to match the luminaire or green moss. Microprismatic screen with optimized glare reduction especially for workplaces. Satin opal diffuser for general lighting with maximum transmittance and homogeneous lighting. Driver integrated into luminaire housing, optionally switchable or dimmable (DALI, Touch-Dim, Casambi). Colour temperature 2200K, 2700K, 3000K, 3500K, 4000K, 6500K or Tunable White (2700-6500K). Binning \leq MacAdam 3. Colour rendering CRI>80, CRI>90 or Full Spectrum. Height-adjustable central cord suspension or parallel cord suspension with transparent power supply cable. Colours ceiling rose match to luminaire body.

RP3 OSL-830 H-D1500-U-AM

- Product Family **R:** Ringo Star
- Type **P3:** Direct-Indirect, **G3:** Direct only
- Optical System **A:** Microprismatic, **O:** Opal Diffuser
- Surface Finish **W:** Snow White, **V:** Ivory White, **S:** Radiant Silver, **U:** Urban Graphite, **B:** Jet Black, **H:** Anodic Champagne, **K:** Satin Copper
- Control Gear **E:** On/Off, **L:** DALI, **H:** Touch-Dim, **C:** Casambi, **U:** Separately Dimmable DALI, **6:** DALI DT6 for TW, **8:** DALI DT8 for TW
- Colour Rendering **8:** CRI>80, **9:** CRI>90, **F:** Full Spectrum [except 2200K]
- Colour Temperature **22:** 2200K, **27:** 2700K, **30:** 3000K, **35:** 3500K, **40:** 4000K, **65:** 6500K, **TW:** Tunable White 2700-6500K [D1500-D2000]
- Power **M:** Medium Power, **H:** High Power
- Size Luminaire Diameter in mm: **D600, D900, D1200, D1500, D2000**
- Suspension **K:** Parallel Suspension, **U:** Central Suspension
- Acoustic Absorb. **AW:** Micro Perforated, **BW:** Beige Wool [D600-D1500], **ZW:** Green Wool [D600-D1500], **GW:** Graphite Wool [D600-D1500], **AM:** Green Moss
- On Request Emergency Module [D1500-D2000]



Microprismatic | Direct-Indirect

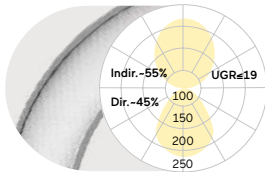

D mm	Lumen/Watt Medium Power
600	6710lm/62W
900	10690lm/99W
1200	13980lm/134W
1500	18860lm/175W
2000	24930lm/239W

Microprismatic | Direct

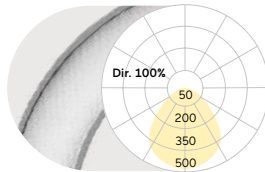

D mm	Lumen/Watt Medium Power	Lumen/Watt High Power
600	2920lm/37W	3960lm/53W
900	4650lm/59W	6030lm/80W
1200	6080lm/81W	8360lm/121W
1500	8220lm/106W	10700lm/143W
2000	10730lm/142W	14230lm/203W

Opal Diffuser | Direct-Indirect

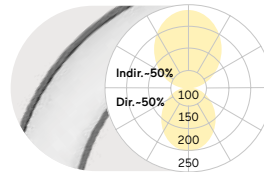

D mm	Lumen/Watt Medium Power
600	6960lm/62W
900	11090lm/99W
1200	14500lm/134W
1500	19560lm/175W
2000	25850lm/239W

Opal Diffuser | Direct

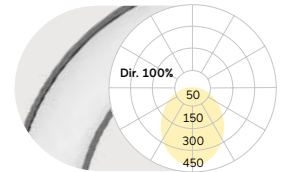

D mm	Lumen/Watt Medium Power	Lumen/Watt High Power
600	3170lm/37W	4300lm/53W
900	5050lm/59W	6540lm/80W
1200	6600lm/81W	9080lm/121W
1500	8920lm/106W	11610lm/143W
2000	11650lm/142W	15450lm/203W

Lumen Values: Luminaire luminous flux at 4000K/CRI>80. Other configurations on request.

Parallel Suspension



Central Suspension



min. 200
max. 4000

min. 0,8 x D
max. 4000

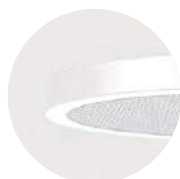

AW Micro Perforated



BW Beige Wool



ZW Green Wool



GW Graphite Wool



AM Green Moss

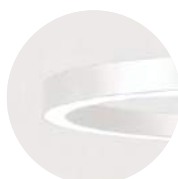

W Snow White



S Radiant Silver



U Urban Graphite



B Jet Black



H Anodic Champagne



K Satin Copper

Ringo Star G1/P1 | System 100mm Suspended



DE LED-Pendelleuchte. Direkt-indirekt oder rein direktstrahlend. Leuchtenkörper aus Aluminiumprofil mit 100mm Profildicke. 13 verschiedene Durchmesser von 600mm bis 8000mm. Oberfläche weiß, silber, graphit, schwarz, champagner oder kupferfarben lackiert. Weitere Oberflächenoptionen siehe Lightnet-Surface-Collection oder RAL nach Wahl. Microprismenoptik mit optimierter Blendungsbegrenzung speziell für Office-Anwendungen. Satiniertes Opaldiffusor für Allgemeinbeleuchtung mit max. Transmissionsgrad und homogener Lichtpunktauflösung. Konverter in Leuchtengehäuse integriert, wahlweise einfach schaltbar oder stufenlos dimmbar (DALI, Touch-Dim, Casambi). Farbtemperatur 2200K, 2700K, 3000K, 3500K, 4000K, 6500K oder Tunable White (2700-6500K). Binning initial \leq MacAdam 3. Farbwiedergabe CRI>80, CRI>90 oder Full Spectrum. Stufenlos höhenverstellbare Zentral-, Parallel- oder Disc-Seilabhängung mit transparent ummantelter Zuleitung. Lackierung Baldachin passend Leuchtenkörper.

EN LED pendant luminaire. Direct-indirect or direct-only light distribution. Luminaire body made of aluminium profile with 100mm profile width. 13 different diameters from 600mm to 8000mm. Surface white, silver, graphite, black, champagne or copper coated. For further surface options see Lightnet-Surface-Collection or RAL of your choice. Microprismatic screen with optimized glare reduction especially for workplaces. Satin opal diffuser for general lighting with maximum transmittance and homogeneous lighting. Driver integrated into luminaire housing, optionally switchable or dimmable (DALI, Touch-Dim, Casambi). Colour temperature 2200K, 2700K, 3000K, 3500K, 4000K, 6500K or Tunable White (2700-6500K). Binning \leq MacAdam 3. Colour rendering CRI>80, CRI>90 or Full Spectrum. Height-adjustable central, parallel or disc cord suspension with transparent power supply cable. Colours ceiling rose match to luminaire body.

RP1 O S L-830 M-D1500-U

- Product Family **R:** Ringo Star
- Type **P1:** Direct-Indirect, **G1:** Direct only
- Optical System **A:** Microprismatic, **O:** Opal Diffuser
- Surface Finish **W:** Snow White, **V:** Ivory White, **S:** Radiant Silver, **U:** Urban Graphite, **B:** Jet Black, **H:** Anodic Champagne, **K:** Satin Copper
- Control Gear **E:** On/Off, **L:** DALI, **H:** Touch-Dim, **C:** Casambi, **U:** Separately Dimmable DALI, **6:** DALI DT6 for TW, **8:** DALI DT8 for TW [D900-D8000]
- Colour Rendering **8:** CRI>80, **9:** CRI>90, **F:** Full Spectrum [except 2200K]
- Colour Temperature **22:** 2200K, **27:** 2700K, **30:** 3000K, **35:** 3500K, **40:** 4000K, **65:** 6500K, **TW:** Tunable White 2700-6500K
- Power **E:** Low Power, **M:** Medium Power
- Size Luminaire Diameter in mm: **D600, D900, D1200, D1500, D2000, D2500, D3000, D3500, D4000, D5000, D6000, D7000, D8000**
- Suspension **K:** Parallel Suspension, **U:** Central Suspension [D600-D2000], **D:** Disc Suspension [D600-D2000]
- On Request Emergency Module [D1200-D8000], Midpin/Midpoint Spotlights



Microprismatic Direct-Indirect			Microprismatic Direct			Opal Diffuser Direct-Indirect			Opal Diffuser Direct		
D mm	Lumen/Watt Low Power	Lumen/Watt Medium Power	D mm	Lumen/Watt Low Power	Lumen/Watt Medium Power	D mm	Lumen/Watt Low Power	Lumen/Watt Medium Power	D mm	Lumen/Watt Low Power	Lumen/Watt Medium Power
600	7510lm/59W	9860lm/79W	600	3810lm/34W	4790lm/45W	600	7790lm/59W	10220lm/79W	600	4090lm/34W	5150lm/45W
900	12360lm/99W	16510lm/134W	900	6460lm/59W	7900lm/75W	900	12830lm/99W	17100lm/134W	900	6930lm/59W	8490lm/75W
1200	16240lm/128W	21930lm/174W	1200	8750lm/79W	10260lm/95W	1200	16890lm/128W	22700lm/174W	1200	9400lm/79W	11030lm/95W
1500	21000lm/162W	27850lm/218W	1500	10980lm/98W	13200lm/120W	1500	21820lm/162W	28830lm/218W	1500	11800lm/98W	14180lm/120W
2000	28010lm/218W	37860lm/299W	2000	14650lm/131W	18330lm/168W	2000	29090lm/218W	39220lm/299W	2000	15730lm/131W	19690lm/168W
2500	33400lm/261W	44410lm/349W	2500	18900lm/166W	23090lm/207W	2500	34800lm/261W	46120lm/349W	2500	20300lm/166W	24800lm/207W
3000	39080lm/305W	51680lm/406W	3000	23260lm/202W	28420lm/252W	3000	40810lm/305W	53780lm/406W	3000	24990lm/202W	30520lm/252W
3500	44630lm/345W	59110lm/459W	3500	26170lm/227W	31970lm/281W	3500	46570lm/345W	61480lm/459W	3500	28110lm/227W	34340lm/281W
4000	54260lm/421W	72180lm/565W	4000	30530lm/271W	37290lm/338W	4000	56520lm/421W	74950lm/565W	4000	32790lm/271W	40060lm/338W
5000	64170lm/506W	84940lm/674W	5000	37800lm/332W	46170lm/414W	5000	66970lm/506W	88370lm/674W	5000	40600lm/332W	49600lm/414W
6000	78160lm/610W	103350lm/811W	6000	46520lm/405W	56830lm/504W	6000	81610lm/610W	107570lm/811W	6000	49970lm/405W	61050lm/504W
7000	97430lm/763W	129520lm/1022W	7000	55240lm/496W	67490lm/617W	7000	101530lm/763W	134530lm/1022W	7000	59340lm/496W	72500lm/617W
8000	107920lm/831W	143320lm/1112W	8000	61780lm/536W	75480lm/667W	8000	112510lm/831W	148920lm/1112W	8000	66370lm/536W	81080lm/667W

Lumen Values: Luminarie luminous flux at 4000K/CRI>80. Other configurations on request.

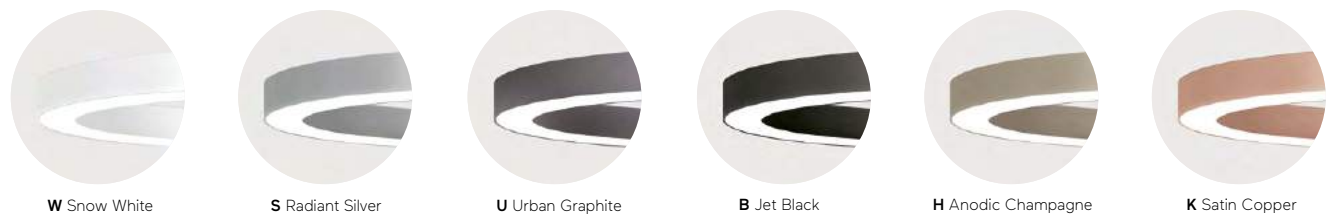

Ringo Star Acoustic G1/P1 | System 100mm Suspended



DE LED-Akustikleuchte für Pendelmontage. Direkt-indirekt oder rein direkt-strahlend. Leuchtenkörper aus Aluminiumprofil mit 100mm Profilbreite. 5 verschiedene Durchmesser von 600mm bis 2000mm. Oberfläche weiß, silber, graphit, schwarz, champagner oder kupferfarben lackiert. Weitere Oberflächenoptionen siehe Lightnet-Surface-Collection oder RAL nach Wahl. Innenliegender Schallabsorber für breites Frequenzspektrum zur Reduktion der Nachhallzeit sowie ein angenehmes Raumklima aus Schafschurwolle aus ökologischer Haltung. Raumseitige Kaschierung wahlweise aus Schurwolle in verschiedenen Farben, aus microperforiertem Stahl in Leuchtenfarbe lackiert oder aus grünem Moos. Microprismenoptik mit optimierter Blendungsbegrenzung speziell für Office-Anwendungen. Satiniertes Opaldiffusor für Allgemeinbeleuchtung mit max. Transmissionsgrad und homogener Lichtpunktauflösung. Konverter in Leuchtengehäuse integriert, wahlweise einfach schaltbar oder stufenlos dimmbar (DALI, Touch-Dim, Casambi). Farbtemperatur 2200K, 2700K, 3000K, 3500K, 4000K, 6500K oder Tunable White (2700-6500K). Binning initial \leq MacAdam 3. Farbwiedergabe CRI>80, CRI>90 oder Full Spectrum. Stufenlos höhenverstellbare Zentral-Seilabhängung oder Parallel-Seilabhängung mit transparent ummantelter Zuleitung. Lackierung Baldachin passend Leuchtenkörper.

EN LED acoustic pendant luminaire. Direct-indirect or direct-only light distribution. Luminaire body made of aluminium profile with 100mm profile width. 5 different diameters from 600mm to 2000mm. Surface white, silver, graphite, black, champagne or copper coated. Further surface options see Lightnet-Surface-Collection or RAL of your choice. Internal sound absorber for a wide frequency spectrum, to reduce the reverberation time. Acoustic insert is available in various colours of ecologically reared sheep's wool, microperforated steel to match the luminaire or green moss. Microprismatic screen with optimized glare reduction especially for workplaces. Satin opal diffuser for general lighting with maximum transmittance and homogeneous lighting. Driver integrated into luminaire housing, optionally switchable or dimmable (DALI, Touch-Dim, Casambi). Colour temperature 2200K, 2700K, 3000K, 3500K, 4000K, 6500K or Tunable White (2700-6500K). Binning \leq MacAdam 3. Colour rendering CRI>80, CRI>90 or Full Spectrum. Height-adjustable central cord suspension or parallel cord suspension with transparent power supply cable. Colours ceiling rose match to luminaire body.

R P1 O S L-8 30 M-D900-U-AW

Product Family	R: Ringo Star
Type	P1: Direct-Indirect, G1: Direct only
Optical System	A: Microprismatic, O: Opal Diffuser
Surface Finish	W: Snow White, V: Ivory White, S: Radiant Silver, U: Urban Graphite, B: Jet Black, H: Champagne Silver, K: Satin Copper
Control Gear	E: On/Off, L: DALI, H: Touch-Dim, C: Casambi, U: Separately Dimmable DALI, 6: DALI DT6 for TW, 8: DALI DT8 for TW [D900-D2000]
Colour Rendering	8: CRI>80, 9: CRI>90, F: Full Spectrum [except 2200K]
Colour Temperature	22: 2200K, 27: 2700K, 30: 3000K, 35: 3500K, 40: 4000K, 65: 6500K, TW: Tunable White 2700-6500K
Power	E: Low Power M: Medium Power
Size	Luminaire Diameter in mm: D600, D900, D1200, D1500, D2000
Suspension	U: Central Suspension, K: Parallel Suspension
Acoustic Absorber	AW: Micro Perforated, BW: Beige Wool [D600-D1500], ZW: Green Wool [D600-D1500], GW: Graphite Wool [D600-D1500], AM: Green Moss
On Request	Emergency Module [D1200-D2000]



Microprismatic Direct-Indirect			Microprismatic Direct			Opal Diffuser Direct-Indirect			Opal Diffuser Direct		
D mm	Lumen/Watt Low Power	Lumen/Watt Medium Power	D mm	Lumen/Watt Low Power	Lumen/Watt Medium Power	D mm	Lumen/Watt Low Power	Lumen/Watt Medium Power	D mm	Lumen/Watt Low Power	Lumen/Watt Medium Power
600	7510lm/59W	9860lm/79W	600	3810lm/34W	4790lm/45W	600	7790lm/59W	10220lm/79W	600	4090lm/34W	5150lm/45W
900	12360lm/99W	16510lm/134W	900	6460lm/59W	7900lm/75W	900	12830lm/99W	17100lm/134W	900	6930lm/59W	8490lm/75W
1200	16240lm/128W	21930lm/174W	1200	8750lm/79W	10260lm/95W	1200	16890lm/128W	22700lm/174W	1200	9400lm/79W	11030lm/95W
1500	21000lm/162W	27850lm/218W	1500	10980lm/98W	13200lm/120W	1500	21820lm/162W	28830lm/218W	1500	11800lm/98W	14180lm/120W
2000	28010lm/218W	37860lm/299W	2000	14650lm/131W	18330lm/168W	2000	29090lm/218W	39220lm/299W	2000	15730lm/131W	19690lm/168W

Lumen Values: Luminaire luminous flux at 4000K/CRI>80. Other configurations on request.

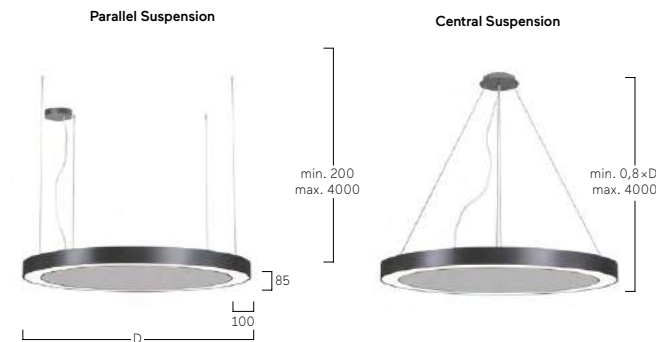

Ringo Star Chandelier Suspended



Cotta Showroom, Herford, Germany
Ringo Star G1 Chandelier; curtain length 5000mm
Photography: Tomas Rodriguez



Nowe Miasto, Bielsko-Biala, Poland
Ringo Star G1 Chandelier; curtain length 1500mm

Ringo Star Chandelier G1/P1 | Suspended



DE LED-Kronleuchter ausgelegt für professionellen Einsatz in Lobbys, Restaurants u.ä. mit hohen Lumenpaketen bei gleichzeitig dekorativer Lichtwirkung. Aufbau aus drei Ringen des Typs Ringo Star-P1/G1, die jeweils mit einem fadenartigen Gewebe umhüllt sind (Material: Trevira CS, permanent schwer entflammbar, Brandklasse DIN 4102 B1, NFPA 701, Farbe: weiß, weiß/silber oder schwarz). Die Fadenlänge beträgt jeweils max. 3m und kann nach Vorgabe gekürzt werden. Direkt-indirekt oder rein direktstrahlend ausgelegt. Leuchtenringe aus Aluminiumprofil mit 100mm Profildicke. Oberfläche weiß, silber, graphit, schwarz, champagner oder kupferfarben lackiert. Weitere Oberflächenoptionen siehe Lightnet-Surface-Collection oder RAL nach Wahl. Satiniertes Opaldiffusor für Allgemeinbeleuchtung mit max. Transmissionsgrad und homogener Lichtpunktauflösung. Konverter in Leuchtgehäuse integriert, wahlweise einfach schaltbar oder stufenlos dimmbar (DALI, Touch-Dim, Casambi). Farbtemperatur 2200K, 2700K, 3000K, 3500K, 4000K, 6500K oder Tunable White (2700-6500K). Binning initial \leq MacAdam 3. Farbwiedergabe CRI $>$ 80, CRI $>$ 90 oder Full Spectrum. Die einzelnen Ringe jeweils mit separater stufenlos höhenverstellbarer Parallel-Seilabhangung. Der Höhenabstand zwischen den einzelnen Ringen kann somit frei gewahlt werden. Eine transparent ummantelte Zuleitung mit frei positionierbarem Deckenbaldachin, Lackierung Deckenbaldachin passend Leuchtenkorper.

EN LED chandelier designed for professional use in lobbies, restaurants, etc. with high lumen packages and decorative lighting effect. Three ring Ringo Star-P1/G1 structure, each wrapped with a thread-like material (Trevira CS, flame retardant, fire class DIN 4102 B1, NFPA 701, colours: white, white/silver or black). The thread length is max. 3m each and can be ordered in shorter lengths to suit specification. Direct-indirect or direct-only light distribution. Luminaire rings made of aluminium profile with 100mm profile width available in white, silver, graphite, black, champagne or copper coated as standard. Further surface options see Lightnet-Surface-Collection or RAL of your choice. Satin opal diffuser for general lighting with maximum transmittance and homogeneous lighting. Driver integrated into luminaire housing, optionally switchable or dimmable (DALI, Touch-Dim, Casambi). Colour temperature 2200K, 2700K, 3000K, 3500K, 4000K, 6500K or Tunable White (2700-6500K). Binning \leq MacAdam 3. Colour rendering CRI $>$ 80, CRI $>$ 90 or Full Spectrum. The individual rings each have a separate, height-adjustable parallel-cord suspension allowing the distance between the individual rings to be specified. Transparent power supply cable with freely positionable ceiling rose, colours ceiling rose match to luminaire body.

R P I O S L - 8 3 0 M - C H 5 4 2 - 1 5 0 0 - K

Product Family	R: Ringo Star
Type	G1: Direct only, P1: Direct-Indirect
Optical System	A: Microprismatic, O: Opal Diffuser
Surface Finish	W: Snow White, V: Ivory White, S: Radiant Silver, U: Urban Graphite, B: Jet Black, H: Anodic Champagne, K: Satin Copper
Control Gear	E: On/Off, L: DALI, H: Touch-Dim, C: Casambi, 6: DALI DT6 for TW, 8: DALI DT8 for TW [D900-D4000]
Colour Rendering	8: CRI>80, 9: CRI>90, F: Full Spectrum [except 2200K]
Colour Temperature	22: 2200K, 27: 2700K, 30: 3000K, 35: 3500K, 40: 4000K, 65: 6500K, TW: Tunable White 2700-6500K
Power	E: Low Power, M: Medium Power
Courtain	CH: Chandelier (without curtain), CW: White Curtain, CS: Silver-White Curtain, CB: Black Curtain
First Luminaire	1: D600, 2: D900, 3: D1200, 4: D1500, 5: D2000, 6: D2500, 7: D3000, 8: D3500, 9: D4000, 0: on request
Second Luminaire	1: D600, 2: D900, 3: D1200, 4: D1500, 5: D2000, 6: D2500, 7: D3000, 8: D3500, 9: D4000, 0: on request
Third Luminaire	1: D600, 2: D900, 3: D1200, 4: D1500, 5: D2000, 6: D2500, 7: D3000, 8: D3500, 9: D4000, 0: on request
Length of Curtain	1500 mm, 3000 mm, 5000 mm
Suspension	K: Parallel Suspension
On Request	Central Suspension



Microprismatic | Direct-Indirect

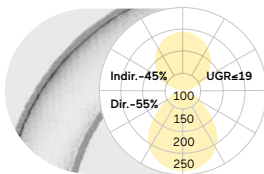

Microprismatic | Direct

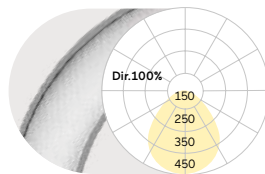

Opal Diffuser | Direct-Indirect

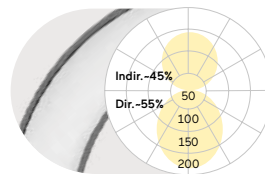

Opal Diffuser | Direct

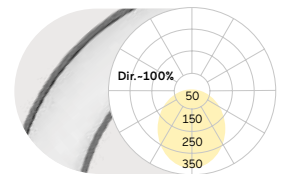

D mm	Lumen/Watt		D mm	Lumen/Watt		D mm	Lumen/Watt		D mm	Lumen/Watt	
	Low Power	Medium Power		Low Power	Medium Power		Low Power	Medium Power		Low Power	Medium Power
600	7510lm/59W	9860lm/79W	600	3810lm/34W	4790lm/45W	600	7790lm/59W	10220lm/79W	600	4090lm/34W	5150lm/45W
900	12360lm/99W	16510lm/134W	900	6460lm/59W	7900lm/75W	900	12830lm/99W	17100lm/134W	900	6930lm/59W	8490lm/75W
1200	16240lm/128W	21930lm/174W	1200	8750lm/79W	10260lm/95W	1200	16890lm/128W	22700lm/174W	1200	9400lm/79W	11030lm/95W
1500	21000lm/162W	27850lm/218W	1500	10980lm/98W	13200lm/120W	1500	21820lm/162W	28830lm/218W	1500	11800lm/98W	14180lm/120W
2000	28010lm/218W	37860lm/299W	2000	14650lm/131W	18330lm/168W	2000	29090lm/218W	39220lm/299W	2000	15730lm/131W	19690lm/168W
2500	33400lm/261W	44410lm/349W	2500	18900lm/166W	23090lm/207W	2500	34800lm/261W	46120lm/349W	2500	20300lm/166W	24800lm/207W
3000	39080lm/305W	51680lm/406W	3000	23260lm/202W	28420lm/252W	3000	40810lm/305W	53780lm/406W	3000	24990lm/202W	30520lm/252W
3500	44630lm/345W	59110lm/459W	3500	26170lm/227W	31970lm/281W	3500	46570lm/345W	61480lm/459W	3500	28110lm/227W	34340lm/281W
4000	54260lm/421W	72180lm/565W	4000	30530lm/271W	37290lm/338W	4000	56520lm/421W	74950lm/565W	4000	32790lm/271W	40060lm/338W

Lumen Values: Luminaire luminous flux at 4000K/CRI>80. Other configurations on request.

Parallel Suspension

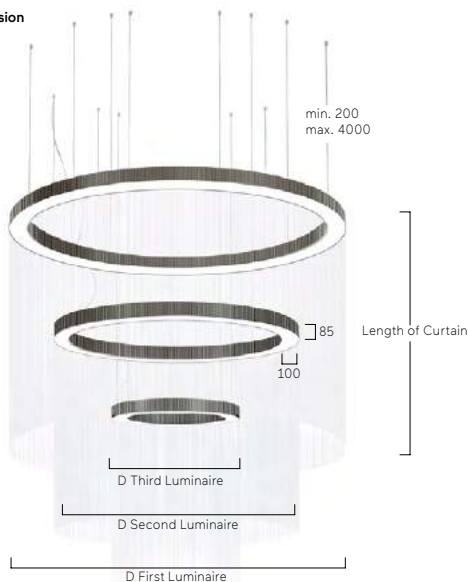

Ringo Star Cluster Suspended

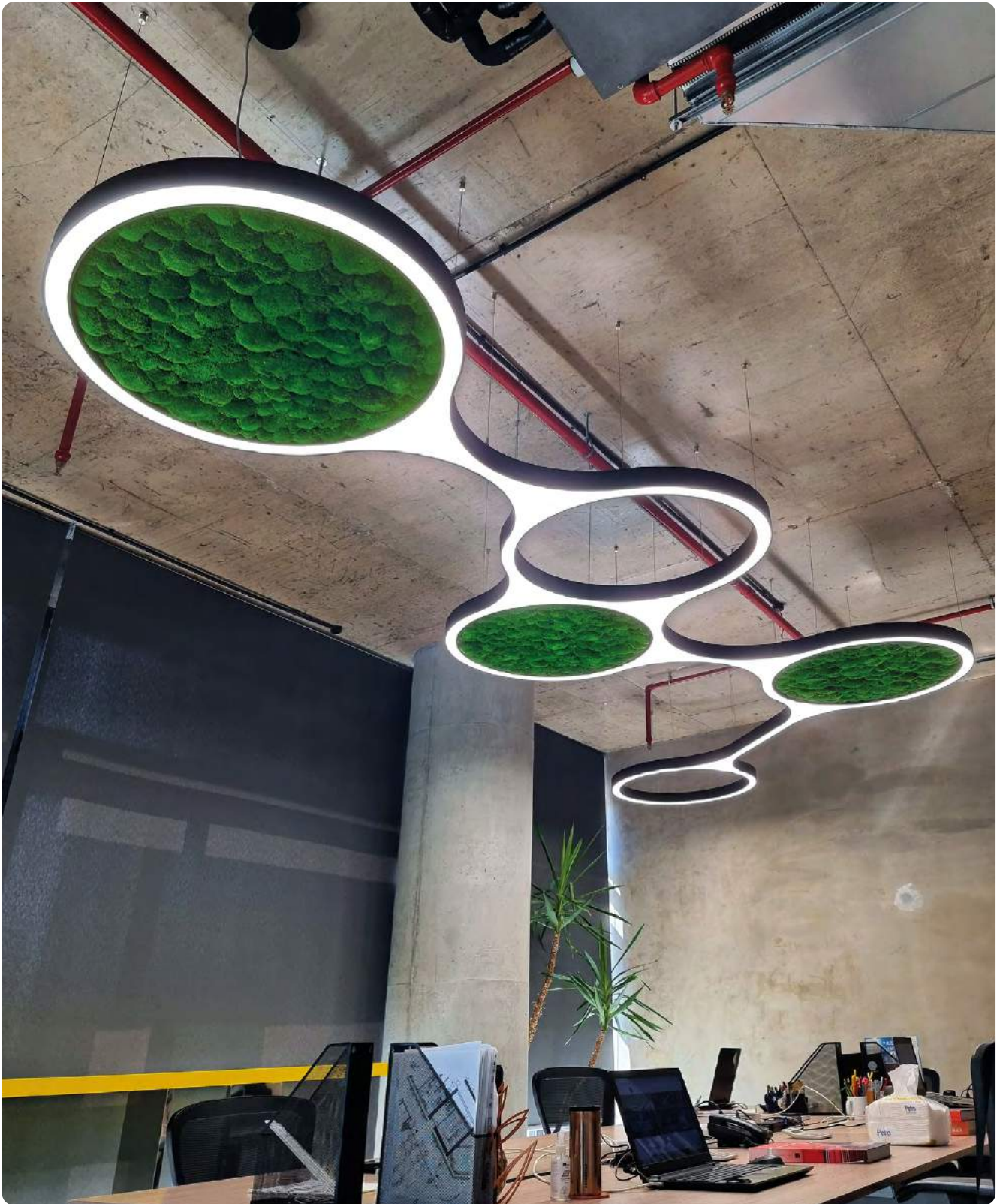

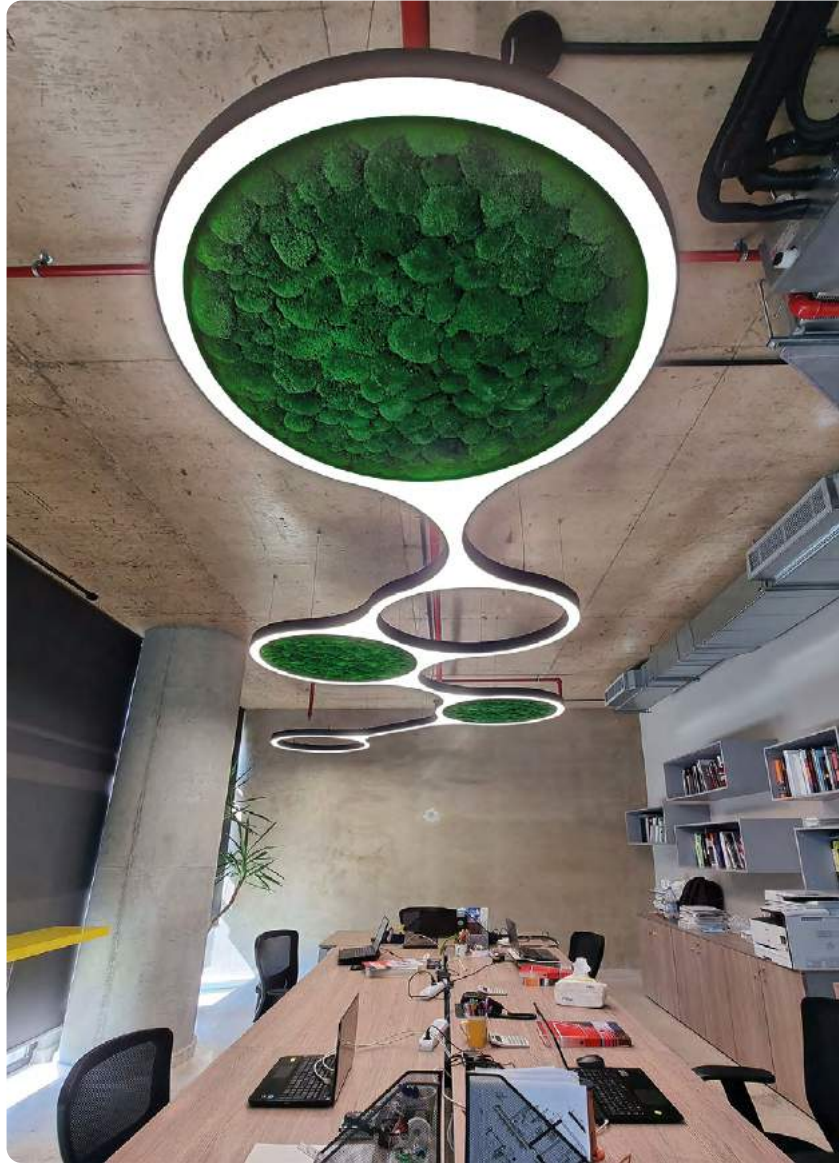

Showroom, Beirut, Libanon
Ringo Star Cluster G3

Ringo Star Cluster Suspended





My Spa, Mainz, Germany
Ringo Star Cluster P3

Ringo Star Cluster Suspended



Sivantos, Erlangen, Germany
Ringo Star Cluster G3
Photography: Alexander Schwarz

Ynergie, Toulouse, France
Ringo Star Cluster G3



Cotta Showroom, Herford, Germany
Ringo Star Cluster G3
Photography: Tomas Rodriguez

Ringo Star Cluster G3/P3 | Suspended



DE LED-System-Pendelleuchte. Direkt-indirekt oder rein direktstrahlend. Lichtsystem für beliebiger Kombination der unterschiedlichen X-, Y- und Kreismodule, jedes Modul als Einzelleuchte erhältlich. Für jede Stoßstelle sind ein Verbinder und eine Seilabhangung separat zu bestellen. Daruber hinaus volle Kompatibilitat mit allen Liquid Line G3/P3 Modulen. Leuchtenkorper aus Aluminiumprofil mit 60mm Profildicke. Oberflache wei, silber, graphit, schwarz, champagner oder kupferfarben lackiert. Weitere Oberflachenoptionen siehe Lightnet-Surface-Collection oder RAL nach Wahl. Optional innenliegendes Akustikelement zur Regulierung der Nachhallzeit. Schallabsorber fur breites Frequenzspektrum, gefertigt aus nachhaltiger Wolle oder grunem Moos. Satinierter Opaldiffuser fur Allgemeinbeleuchtung. Konverter jeweils in Leuchtengehause integriert, wahlweise einfach schaltbar oder stufenlos dimmbar (DALI, Touch-Dim, Casambi). Farbtemperaturen 2200K, 2700K, 3000K, 3500K, 4000K oder 6500K. Binning initial \leq MacAdam 3. Farbwiedergabe CRI>80, CRI>90 oder Full Spectrum. Deckenbaldachin mit transparent ummantelter Zuleitung je gesamte Lichtstruktur separat zu bestellen. Lackierung Baldachin passend Leuchtenkorper.

EN LED pendant light system. Direct-indirect or direct-only light distribution. Lighting system with various combinations of the different X, Y and circular modules, each module available as stand-alone luminaire. A connector and a cord-holder have to be ordered separately for each joint. Furthermore entirely compatible with all Liquid Line G3/P3 modules. Luminaire body made of aluminium profile with 60mm profile width. Surface white, silver, graphite, black, champagne or copper coated. Further surface options see Lightnet-Surface-Collection or RAL of your choice. Optional internal acoustic absorber suitable for wide frequency spectrum, made from ecologically reared sheep's wool or green moss. Satin opal diffuser for general lighting. Driver in each case integrated into luminaire housing, optionally switchable or dimmable (DALI, Touch-Dim, Casambi). Colour temperature 2200K, 2700K, 3000K, 3500K, 4000K or 6500K. Binning \leq MacAdam 3. Colour rendering CRI>80, CRI>90 or Full Spectrum. Ceiling rose with transparent power supply cable to be ordered separately for each complete light structure. Colours ceiling rose match to luminaire body.

RP3 OSE-830 M-C1-K

- Product Family **R:** Ringo Star
- Type **P3:** Direct-Indirect, **G3:** Direct only
- Optical System **O:** Opal Diffuser
- Surface Finish **W:** Snow White, **V:** Ivory White, **S:** Radiant Silver, **U:** Urban Graphite, **B:** Jet Black, **H:** Anodic Champagne, **K:** Satin Copper
- Control Gear **E:** On/Off, **L:** DALI, **H:** Touch-Dim, **C:** Casambi, **U:** Separately Dimmable DALI
- Colour Rendering **8:** CRI>80, **9:** CRI>90, **F:** Full Spectrum [except 2200K]
- Colour Temperature **22:** 2200K, **27:** 2700K, **30:** 3000K, **35:** 3500K, **40:** 4000K, **65:** 6500K
- Power **E:** Low Power **M:** Medium Power
- Module Type **C1:** 1/6 Circle, **C2:** 2/6 Circle, **C3:** 3/6 Circle, **C4:** 4/6 Circle, **C5:** 5/6 Circle, **Y:** Y-Module, **X:** X-Module
- Suspension **K:** Parallel Suspension
- On Request Acoustic Absorber



Opal Diffuser | Direct-Indirect

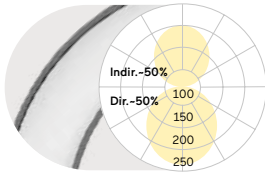

Opal Diffuser | Direct

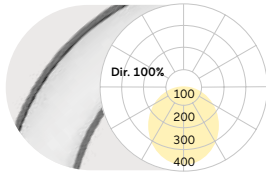

Module Type	Lumen/Watt	
	Low Power	Medium Power
C1	920lm/11W	1330lm/16W
C2	2520lm/24W	3570lm/34W
C3	3840lm/35W	5450lm/50W
C4	5270lm/46W	7610lm/70W
C5	6710lm/57W	9700lm/86W
Y	2760lm/28W	4010lm/41W
X	5520lm/55W	8020lm/81W

Module Type	Lumen/Watt	
	Low Power	Medium Power
C1	650lm/8W	950lm/12W
C2	1310lm/16W	1910lm/23W
C3	1910lm/22W	2790lm/32W
C4	2610lm/29W	3820lm/45W
C5	3260lm/36W	4770lm/55W
Y	1960lm/22W	2870lm/33W
X	3920lm/44W	5740lm/66W

Lumen Values: Luminaire luminous flux at 4000K/CRI>80. Other configurations on request.

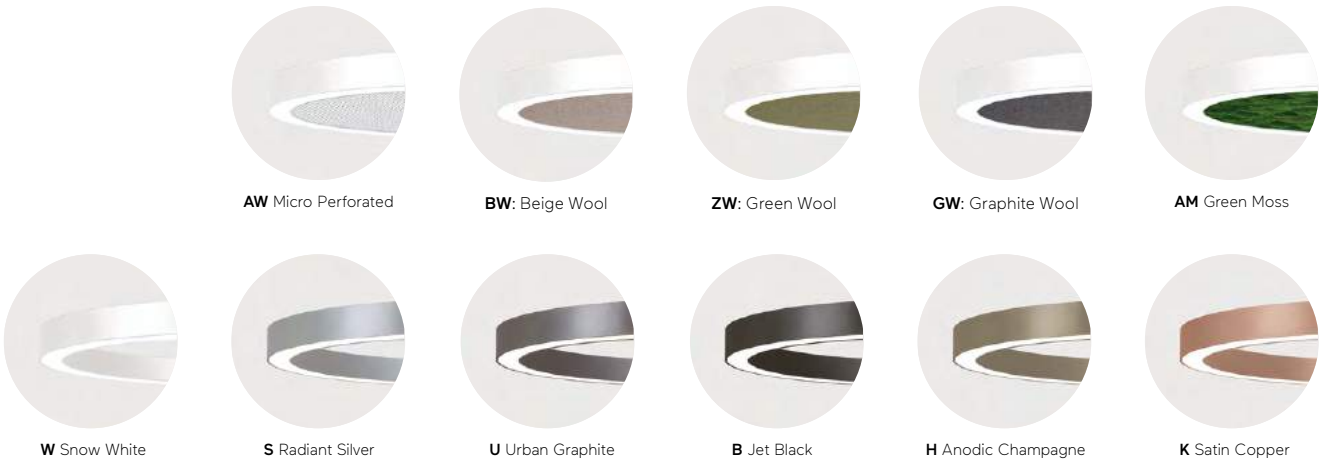
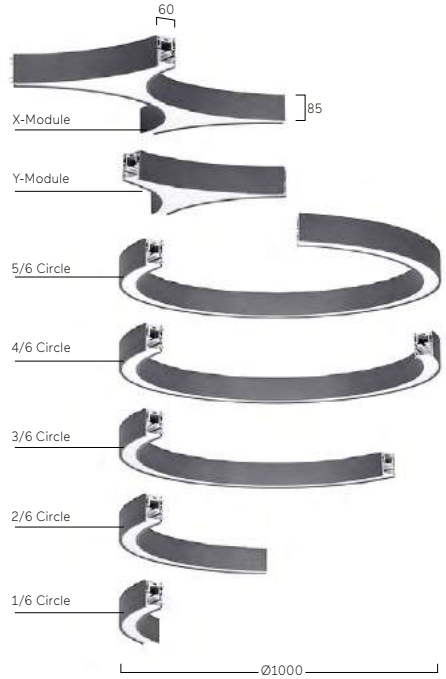

Ringo Star Chain G3/P3 | Suspended



DE LED-Pendelleuchte. Fertig konfigurierte Lichtstruktur mit allen erforderlichen Lichtmodulen, Verbindern und Seilabhängungen. Direkt-indirekt oder rein direktstrahlend. Leuchtenkörper aus Aluminiumprofil mit 60mm Profildicke. Oberfläche weiß, silber, graphit, schwarz, champagner oder kupferfarben lackiert. Weitere Oberflächenoptionen siehe Lightnet-Surface-Collection oder RAL nach Wahl. Optional innenliegendes Akustikelement zur Regulierung der Nachhallzeit. Schallabsorber für breites Frequenzspektrum, gefertigt aus nachhaltiger Wolle oder grünem Moos. Satiniertes Opaldiffusor für Allgemeinbeleuchtung. Konverter jeweils in Leuchtengehäuse integriert, wahlweise einfach schaltbar oder stufenlos dimmbar (DALI, Touch-Dim, Casambi). Farbtemperaturen 2200K, 2700K, 3000K, 3500K, 4000K oder 6500K. Binning initial \leq MacAdam 3. Farbwiedergabe CRI $>$ 80, CRI $>$ 90 oder Full Spectrum. Stufenlos höhenverstellbare Parallel-Seilabhängung mit transparent ummantelter Zuleitung. Lackierung Baldachin passend Leuchtenkörper.

EN LED pendant luminaire. Completely configured light structure with all necessary light modules, connectors and cord-holders. Direct-indirect or direct-only light distribution. Luminaire body made of aluminium profile with 60mm profile width. Standard colour finishes in white, silver, graphite, black, champagne or copper coated. For further surface options see Lightnet-Surface-Collection or RAL of your choice. Optional internal acoustic absorber suitable for wide frequency spectrum, made from ecologically reared sheep's wool or green moss. Satin opal diffuser for general lighting. Driver in each case integrated into luminaire housing, optionally switchable or dimmable (DALI, Touch-Dim, Casambi). Colour temperature 2200K, 2700K, 3000K, 3500K, 4000K or 6500K. Binning \leq MacAdam 3. Colour rendering CRI $>$ 80, CRI $>$ 90 or Full Spectrum. Height-adjustable parallel cord suspension with transparent power supply cable. Colours ceiling rose match to luminaire body.

R P3 O SE-8 30 M-2R-K

- Product Family **R:** Ringo Star
- Type **P3:** Direct-Indirect, **G3:** Direct only
- Optical System **O:** Opal Diffuser
- Surface Finish **W:** Snow White, **V:** Ivory White, **S:** Radiant Silver, **U:** Urban Graphite, **B:** Jet Black, **H:** Anodic Champagne, **K:** Satin Copper
- Control Gear **E:** On/Off, **L:** DALI, **H:** Touch-Dim, **C:** Casambi, **U:** Separately Dimmable DALI
- Colour Rendering **8:** CRI>80, **9:** CRI>90, **F:** Full Spectrum [except 2200K]
- Colour Temperature **22:** 2200K, **27:** 2700K, **30:** 3000K, **35:** 3500K, **40:** 4000K, **65:** 6500K
- Power **E:** Low Power **M:** Medium Power
- Module Type **2R:** 2 Rings, **3R:** 3 Rings, **4R:** 4 Rings, **5R:** 5 Rings
- Suspension **K:** Parallel Suspension
- On Request Acoustic Absorber



Opal Diffuser | Direct-Indirect

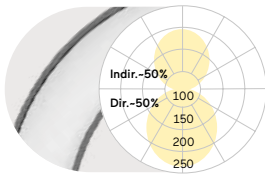

Module Type	Length [mm]	Lumen/Watt Low Power	Lumen/Watt Medium Power
2 Rings	1940	16060lm/146W	23240lm/218W
3 Rings	2880	23420lm/209W	33920lm/326W
4 Rings	3820	30780lm/272W	44600lm/434W
5 Rings	4760	38140lm/333W	55280lm/540W

Opal Diffuser | Direct

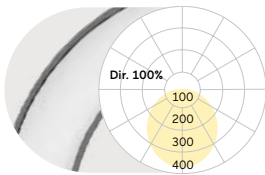

Module Type	Length [mm]	Lumen/Watt Low Power	Lumen/Watt Medium Power
2 Rings	1940	9140lm/102W	13380lm/156W
3 Rings	2880	14360lm/151W	21020lm/244W
4 Rings	3820	19580lm/200W	28660lm/332W
5 Rings	4760	24800lm/249W	36300lm/420W

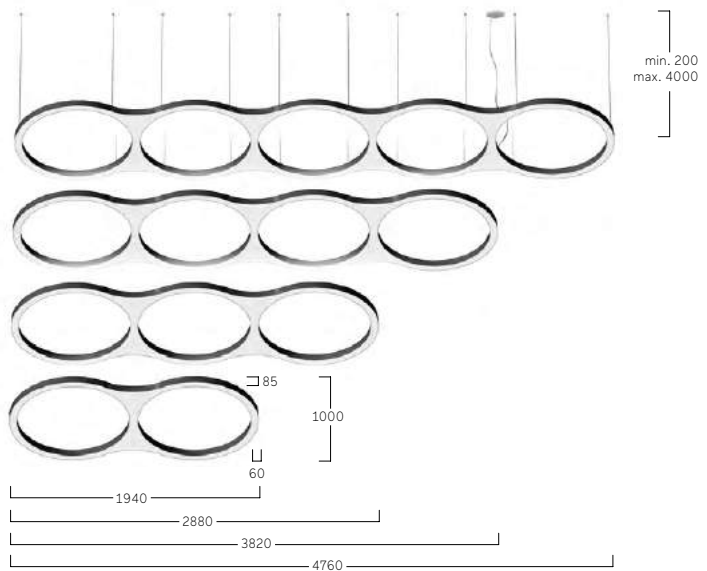

Lumen Values: Luminaire luminous flux at 4000K/CRI>80. Other configurations on request.

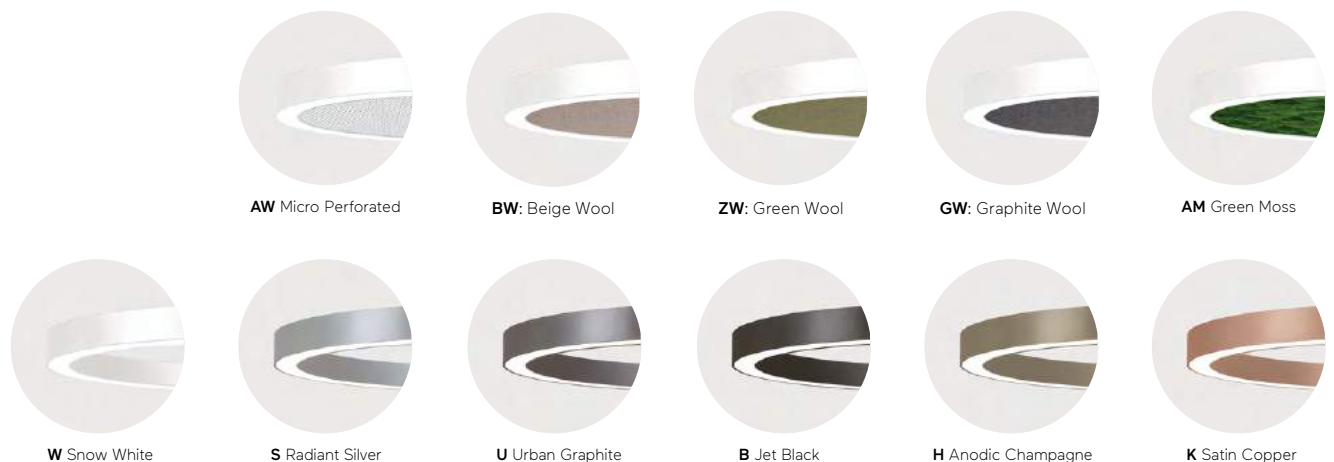

Ringo Star Oblong GX/PX | Suspended



DE LED-Pendelleuchte. Direkt-indirekt oder rein direktstrahlend. Leuchtenkörper aus Aluminiumprofil mit 40mm Profildbreite. Standardmäßig in zwei Breiten und jeweils drei Längen. Sonderlängen auf Anfrage möglich. Oberfläche weiß, silber, graphit, schwarz, champagner oder kupferfarben lackiert. Weitere Oberflächenoptionen siehe Lightnet-Surface-Collection oder RAL nach Wahl. Direktanteil über Präzisionslinsen mit Abblendraster für breite rotationssymmetrische Lichtstärkeverteilung bei gleichzeitig hoher Blendungsbegrenzung (UGR<19) speziell für Office Anwendungen. Abblendraster in verschiedenen Farbkombinationen erhältlich. Satinierter Opaldiffusor für Allgemeinbeleuchtung mit max. Transmissionsgrad und homogener Lichtpunktauflösung. Konverter in Leuchtengehäuse integriert, wahlweise einfach schaltbar oder stufenlos dimmbar (DALI, Touch-Dim, Casambi). Farbtemperatur 2200K, 2700K, 3000K, 3500K, 4000K oder 6500K. Binning initial \leq MacAdam 3. Farbwiedergabe CRI>80, CRI>90 oder Full Spectrum. Stufenlos höhenverstellbare Parallel-Seilabhängung mit transparent ummantelter Zuleitung. Lackierung Baldachin passend Leuchtenkörper.

EN LED pendant luminaire. Direct-indirect or direct-only light distribution. Luminaire body made of aluminium profile with 40mm profile width. Available as standard in two widths and three lengths each. Special lengths available on request. Standard colour finishes white, silver, graphite, black, champagne or copper coated. Further surface options see Lightnet-Surface-Collection or RAL of your choice. Direct light using precision lenses with louvre for wide uniform symmetrical light distribution with high glare limitation (UGR<19) especially for workplaces. Louvre available in various colour finishes. Satin opal diffuser for general lighting with maximum transmittance and homogeneous lighting. Driver integrated into luminaire housing, optionally switchable or dimmable (DALI, Touch-Dim, Casambi). Colour temperature 2200K, 2700K, 3000K, 3500K, 4000K or 6500K. Binning \leq MacAdam 3. Colour rendering CRI>80, CRI>90 or Full Spectrum. Height-adjustable parallel cord suspension with transparent power supply cable. Colours ceiling rose match to luminaire body.

R P X L W E - 8 3 0 M - O 6 1 - K B *

Product Family	R: Ringo Star
Type	PX: Direct-Indirect, GX: Direct only
Optical System	C: Opal Flex Diffuser, L: Lens Louvre*
Surface Finish	W: Snow White, V: Ivory White, A: Satin Silver, S: Radiant Silver, U: Urban Graphite, B: Jet Black, H: Anodic Champagne, K: Satin Copper
Control Gear	E: On/Off, L: DALI, C: Casambi, H: Touch-Dim
Colour Rendering	8: CRI>80, 9: CRI>90, F: Full Spectrum [except 2200K]
Colour Temperature	22: 2200K, 27: 2700K, 30: 3000K, 35: 3500K, 40: 4000K, 65: 6500K
Power	E: Low Power, M: Medium Power, H: High Power
Size	Luminaire Dimension: O61- L1790 D600, O62- L2450 D600, O91- L1820 D900, O92- L2480 D900
Suspension	K: Parallel Suspension
Lens Louvre*	W: Snow White, A: Satin Silver, B: Jet Black, H: Anodic Champagne, K: Satin Copper, G: Satin Gold
On Request	Midpin Spotlights



Lens Louvre Direct-Indirect			Lens Louvre Direct			Opal Flex Diffuser Direct-Indirect			Opal Flex Diffuser Direct		
Type	Lumen/Watt Low Power	Lumen/Watt Medium Power	Type	Lumen/Watt Low Power	Lumen/Watt High Power	Type	Lumen/Watt Low Power	Lumen/Watt Medium Power	Type	Lumen/Watt Medium Power	Lumen/Watt High Power
O61	12860lm/100W	18000lm/145W	O61	6770lm/53W	12350lm/102W	O61	10580lm/93W	14640lm/133W	O61	6250lm/64W	8880lm/92W
O62	16980lm/134W	23790lm/189W	O62	8940lm/71W	16340lm/133W	O62	13950lm/122W	19320lm/171W	O62	8240lm/81W	11730lm/121W
O91	14070lm/107W	19650lm/156W	O91	7400lm/55W	13570lm/109W	O91	11550lm/103W	15910lm/143W	O91	6800lm/70W	9610lm/101W
O92	18200lm/139W	25430lm/201W	O92	9580lm/73W	17560lm/148W	O92	14920lm/130W	20580lm/182W	O92	8790lm/88W	12460lm/130W

Lumen Values: Luminaire luminous flux at 4000K/CRI>80. Other configurations on request.

Parallel Suspension

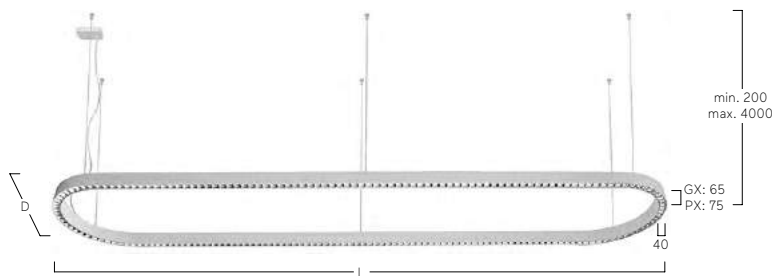

Midpin Spotlight XP
770lm/10W/Ø40mm



W Snow White
A Satin Silver
B Jet Black
H Anodic Champagne
K Satin Copper
G Satin Gold

Liquid Line Compact G5/P5 | Suspended



DE LED-Pendelleuchte. Direkt-indirekt oder rein direktstrahlend. Leuchtenkörper mit feinen Radien aus Aluminium, gefertigt aus einem Guss ohne sichtbare Nahtstellen an den Stirnseiten. Oberfläche in weiß, silber, graphit, schwarz oder champagnerfarben lackiert. Weitere Oberflächenoptionen siehe Lightnet Surface Collection oder RAL nach Wahl. Präzisionslinsen mit Abblendraster für breite rotationsymmetrische Lichtstärkeverteilung bei gleichzeitig hoher Blendungsbegrenzung ($UGR < 19$). Abblendraster in verschiedenen Oberflächen verfügbar. Satinierter Opaldiffusor für Allgemeinbeleuchtung mit max. Transmissionsgrad und homogener Lichtpunktauflösung. Konverter in Deckendose integriert, wahlweise einfach schaltbar oder stufenlos dimmbar (DALI). Farbtemperatur 2200K, 2700K, 3000K, 3500K, 4000K oder 6500K. Binning initial \leq MacAdam 3. Farbwiedergabe $CRI > 80$, $CRI > 90$ oder Full Spectrum. Stromführende Seilabhängung ohne zusätzliche Kabel. Lackierung Baldachin passend Leuchtenkörper.

EN LED pendant luminaire. Direct-indirect or direct-only light distribution. Luminaire body with smooth bends made of aluminium, crafted in one piece with no visible seams at the ends. Standard colour finishes, white, silver, graphite, black or champagne coated. Further surface options see Lightnet-Surface-Collection or RAL of your choice. Precision lenses with louvre for wide uniform symmetrical light distribution with high glare limitation ($UGR < 19$). Louvre available in various surfaces. Satin opal diffuser for general lighting with maximum transmittance and homogeneous lighting. Driver integrated into ceiling box, optionally switchable or dimmable (DALI). Colour temperature 2200K, 2700K, 3000K, 3500K, 4000K or 6500K. Binning \leq MacAdam 3. Colour rendering $CRI > 80$, $CRI > 90$ or Full Spectrum. Current-carrying cord suspension without additional cables. Colours ceiling rose match to luminaire body.

QG5LWE-830H-L139-AB*

Product Family	Q: Liquid line
Type	G5: Direct only, P5: Direct-indirect
Optical System	O: Opal Diffuser, L: Lens Louvre*
Surface Finish	W: Snow White, V: Ivory White, A: Satin Silver, S: Radiant Silver, U: Urban Graphite, B: Jet Black, H: Anodic Champagne, K: Satin Copper
Control Gear	E: On/Off, L: DALI, H: Touch-Dim
Colour Rendering	8: CRI>80, 9: CRI>90, F: Full Spectrum [except 2200K]
Colour Temperature	22: 2200K, 27: 2700K, 30: 3000K, 35: 3500K, 40: 4000K, 65: 6500K
Power	M: Medium Power, H: High Power
Size	Luminaire Length in mm: L139
Suspension	A: Single Cord Suspension
Lens Louvre*	W: Snow White, A: Satin Silver, B: Jet Black, H: Anodic Champagne, K: Satin Copper, G: Satin Gold



Lens Louvre | Direct-Indirect

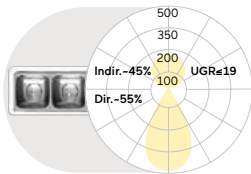

L	Lumen/Watt	Lumen/Watt
mm	Medium Power	High Power
139	1080lm/12W	1450lm/16W

Lens Louvre | Direct

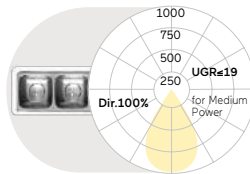

L	Lumen/Watt	Lumen/Watt
mm	Medium Power	High Power
139	620lm/7W	820lm/9W

Opal Diffuser | Direct-Indirect

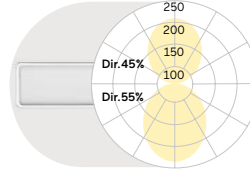

L	Lumen/Watt	Lumen/Watt
mm	Medium Power	High Power
139	990lm/12W	1350lm/16W

Opal Diffuser | Direct

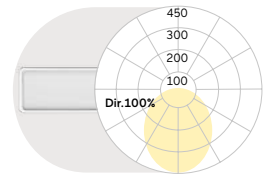

L	Lumen/Watt	Lumen/Watt
mm	Medium Power	High Power
139	530lm/7W	720lm/9W

Lumen Values: Luminaire luminous flux at 4000K/CRI>80. Other configurations on request.

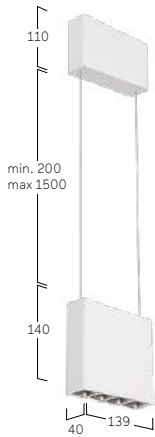

Liquid Line GX/PX | System 40mm Suspended



DE LED-System-Pendelleuchte. Direkt-indirekt oder rein direktstrahlend. Hochflexibles System bestehend aus linearen Elementen, vertikal und horizontal gebogenen Elementen sowie Y- und X-Verbindungselementen. Jedes Modul ist dabei als unabhängige Einzelleuchte mit integriertem Konverter konzipiert und kann mit den anderen Modulen durch ein durchdachtes Konnektor-System zu beliebigen Lichtstrukturen verbunden werden. Millimetergenaue Längenfertigung sowie Sonderradien (nur Opal) möglich. Auf Grundlage skizzierter Kundenvorgabe erstellt Lightnet technische Zeichnung der gewünschten Struktur zur Prüfung und Freigabe. Leuchtenkörper mit feinen Radien aus Aluminiumprofil mit 40mm Profildicke, gefertigt aus einem Guss ohne sichtbare Nahtstellen an den Stirnseiten. Oberfläche weiß, silber, graphit, schwarz, champagner oder kupferfarben lackiert.

Weitere Oberflächenoptionen siehe Lightnet-Surface-Collection oder RAL nach Wahl. Präzisionslinsen mit Abblenkraster für breite rotationssymmetrische Lichtstärkeverteilung bei gleichzeitig hoher Blendungsbegrenzung ($UGR < 19$). Abblenkraster in verschiedenen Oberflächen verfügbar. Satiniertes Opaldiffusor für Allgemeinbeleuchtung mit max. Transmissionsgrad und homogener Lichtpunktauflösung. Konverter wahlweise einfach schaltbar oder stufenlos dimmbar (DALI, Touch-Dim, Casambi). Farbtemperatur 2200K, 2700K, 3000K, 3500K, 4000K oder 6500K. Binning initial \leq MacAdam 3. Farbwiedergabe $CRI > 80$, $CRI > 90$ oder Full Spectrum. Stufenlos höhenverstellbare Seilabhängung mit transparent ummantelter Zuleitung. Lackierung Baldachin passend Leuchtenkörper.

Linear Modules

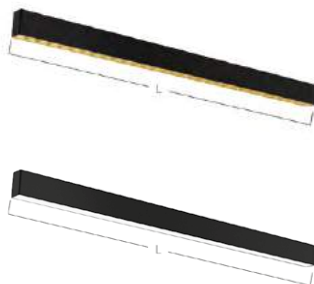

Lens Louvre

L[mm]	668	932	1197	1461	1726	1990
-------	-----	-----	------	------	------	------

Opal Flex Diffuser

L[mm]	600	890	1182	1475	1765	2055
-------	-----	-----	------	------	------	------

Curve Modules

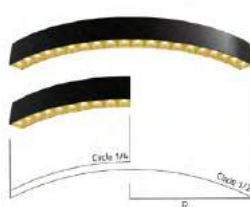
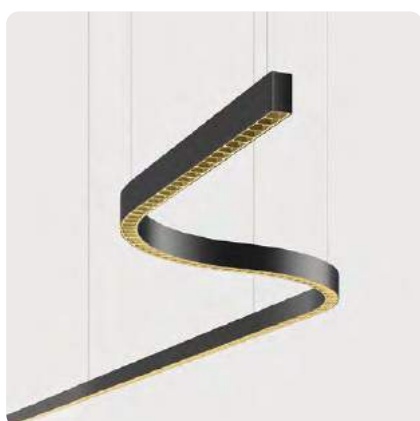

1/2 Curve, Lens Louvre

R[mm]	300	450	622,5
L[mm]	942	1414	1956

1/4 Curve, Lens Louvre

R[mm]	300	450	622,5
L[mm]	471	708	978

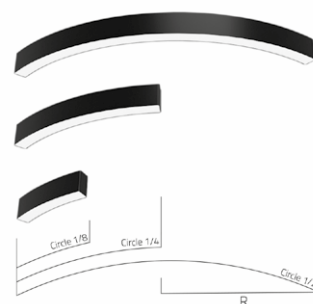

1/2 Curve, Opal Flex Diffuser

R[mm]	300	450	622,5	750
L[mm]	942	1414	1956	2356

1/4 Curve, Opal Flex Diffuser

R[mm]	300	622,5	750	1000
L[mm]	471	978	1178	1570

1/8 Curve, Opal Flex Diffuser

R[mm]	300	622,5	1000
L[mm]	236	489	785

EN LED pendant light system. Direct-indirect or direct-only light distribution. Highly flexible system consisting of linear elements, vertically and horizontally curved elements and Y- and X-connectors. Each module is designed as a stand-alone luminaire with an integrated driver and can be connected to the other modules using a sophisticated connector system to create any desired lighting structure. Millimeter-precise production as well as special curves (Opal only) possible. Based on customer specifications, Lightnet creates technical drawings of the desired structure for review and approval. Luminaire body with smooth bends made of 40mm wide aluminium profile, crafted in one piece with no visible seams at the ends.

Standard colour finishes, white, silver, graphite, black, champagne or copper coated. Further surface options see Lightnet-Surface-Collection or RAL of your choice. Precision lenses with louvre for wide uniform symmetrical light distribution with high glare limitation ($UGR < 19$). Louvre available in various colour finishes. Satin opal diffuser for general lighting with maximum transmittance and homogeneous lighting. Driver optionally switchable or dimmable (DALI, Touch-Dim, Casambi). Colour temperature 2200K, 2700K, 3000K, 3500K, 4000K or 6500K. Binning \leq MacAdam 3. Colour rendering $CRI > 80$, $CRI > 90$ or Full Spectrum. Height-adjustable cord suspension with transparent power supply cable. Colours ceiling rose match to luminaire body.

Bend Modules

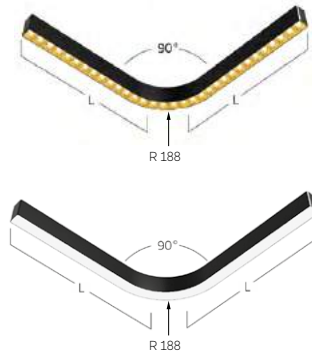

Lens Louvre

L[mm]	584	716	981
-------	-----	-----	-----

Opal Flex Diffuser

L[mm]	580	675	960
-------	-----	-----	-----

Wave Modules

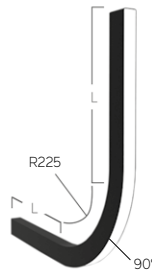

Opal Flex Diffuser

L[mm]	280	375	470
-------	-----	-----	-----

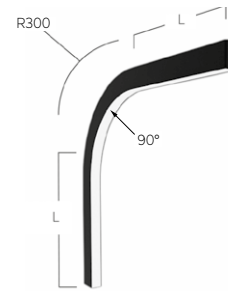

Opal Flex Diffuser

L[mm]	280	375	470
-------	-----	-----	-----

X-Junction Modules

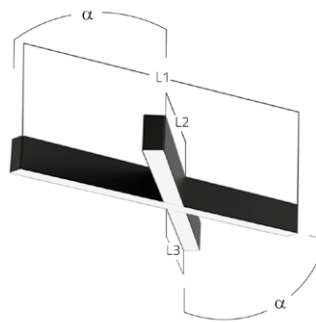

Opal Flex Diffuser

	L1 [mm]	L2 [mm]	L3 [mm]
∞ 90°	570	285	285
∞ 45°	570	315	315

Y-Junction Modules

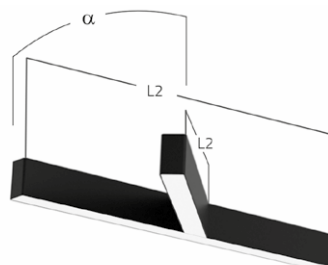

Opal Flex Diffuser

	L1 [mm]	L2 [mm]
∞ 90°	570	285
∞ 45°	570	315



Lens Louvre | Direct-Indirect

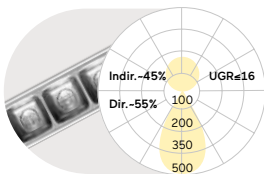

Lumen/Watt Low Power 3070lm/23,7W per m

Lumen/Watt Medium Power 4340lm/34,2W per m

Lens Louvre | Direct

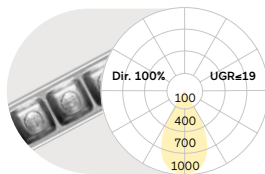

Lumen/Watt Low Power 1640lm/12,6W per m

Lumen/Watt High Power 3020lm/24,3W per m

Opal Flex Diffuser | Direct-Indirect

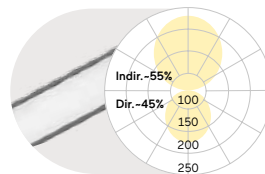

Lumen/Watt Low Power 2540lm/22,2W per m

Lumen/Watt Medium Power 3550lm/31,4W per m

Opal Flex Diffuser | Direct

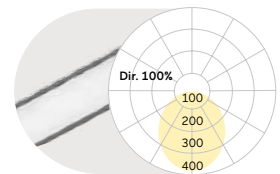

Lumen/Watt Medium Power 1550lm/15,6W per m

Lumen/Watt High Power 2150lm/21,8W per m

Lumen Values: Luminaire luminous flux at 4000K/CRI>80. Other configurations on request.

Single Cord Suspension:



- IP20
-
- ~220-240V
- 50-60 Hz
- IK 02
- RG0
- ≤3 MacAdam
- LOW POWER L90810 50000h
- MEDIUM POWER L85810 50000h
- HIGH POWER L80810 50000h
- CE
- UK CA



Midpin Spotlight XM
770lm/10W/Ø40mm



Midpin Spotlight XP
770lm/10W/Ø40mm



W Snow White
W Snow White



W Snow White
A Satin Silver



W Snow White
B Jet Black



W Snow White
H Anodic Champagne



W Snow White
K Satin Copper



W Snow White
G Satin Gold

Liquid Line Suspended





Airport Visitor Center, Frankfurt, Germany
Liquid Line P3
Photography: Tomas Rodriguez



Liquid Line Suspended

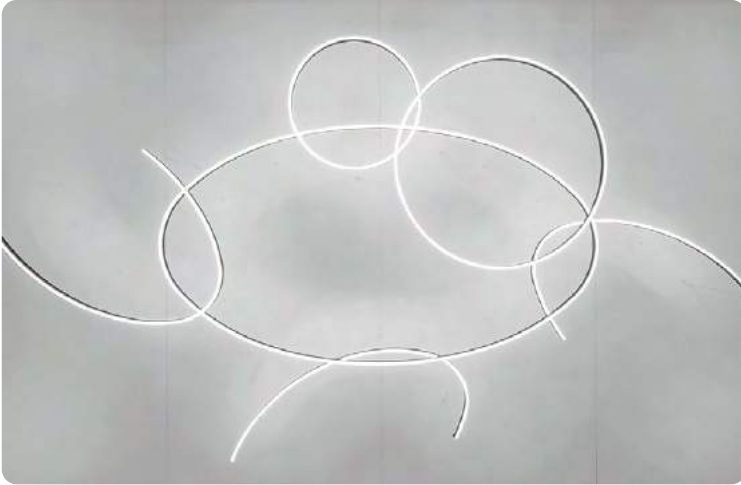

Federal Office for Migration and Refugees
Nuremberg, Germany
Liquid Line P3
Photography: Alexander Schwarz



Liquid Line Suspended



Vogel Convention Center, Würzburg, Germany
Liquid Line P3

Photography: Eydos GmbH/Brigitte Sauer,
Agency for Corporate Interior and Exhibition Design





Liquid Line Suspended

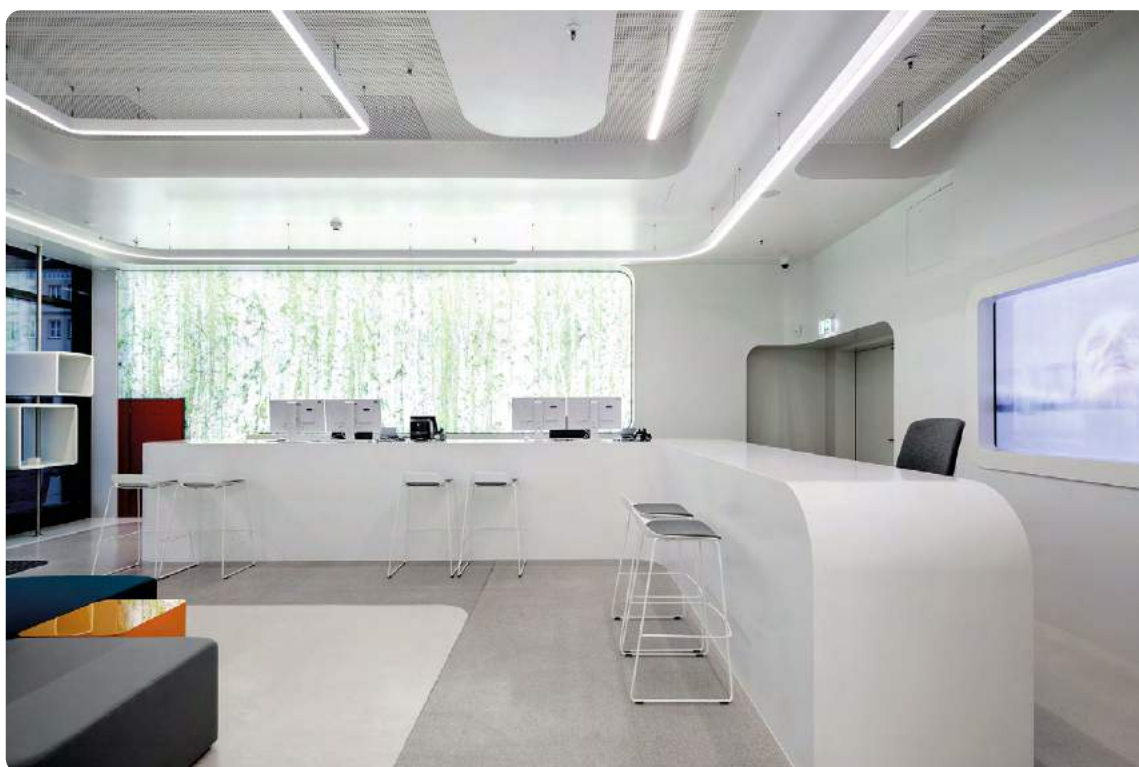

Public Utility Customer Centre
Neubrandenburg, Germany
Liquid Line G3
Photography: Andreas Muhs



Huawei Shop, Paris, France
Liquid Line G3

Liquid Line Suspended



Office building Bömers Spitze
Overseas City Bremen, Germany
Liquid Line G3





AXA Office, Paris, France
Liquid Line G3

Liquid Line Suspended



Ideal Insurance, Berlin, Germany
Liquid Line G3





Library, Berlin, Germany
Liquid Line P3

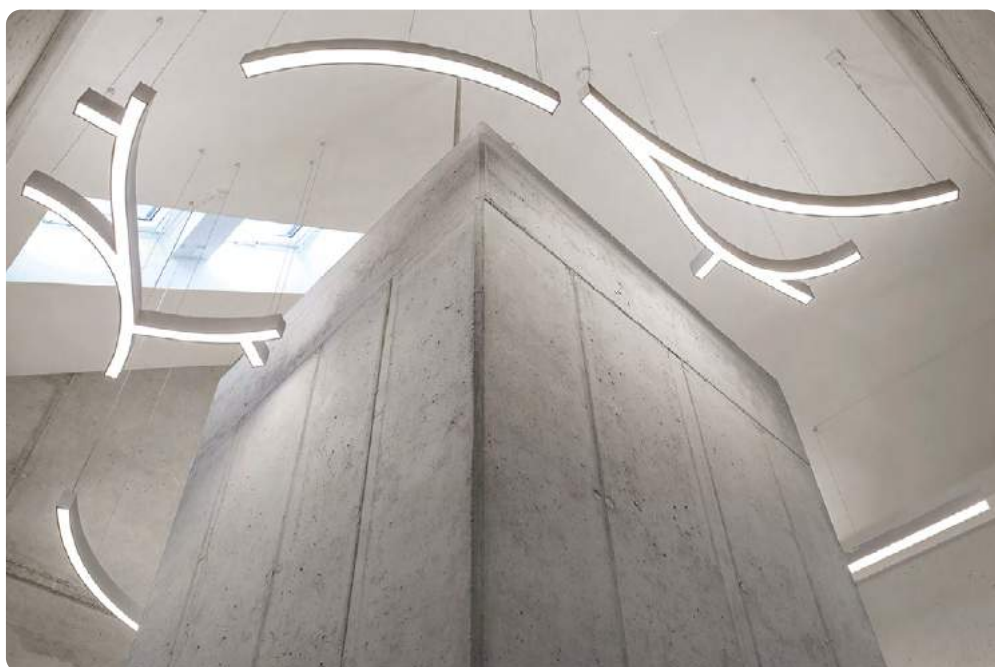

Liquid Line G3/P3 | System 60mm Suspended



DE LED-System-Pendelleuchte. Direkt-indirekt oder rein direktstrahlend. Hochflexibles System bestehend aus linearen Elementen, vertikal und horizontal gebogenen Elementen sowie Y- und X-Verbindungselementen. Jedes Modul ist dabei als unabhängige Einzeleuchte mit integriertem Konverter konzipiert und kann mit den anderen Modulen durch ein intelligentes Konnektor-System zu beliebigen Lichtstrukturen verbunden werden. Millimetergenaue Längenfertigung sowie Sonderradien durch intelligentes softwarebasiertes Produktionssystem in Stückzahl 1 möglich. Auf Grundlage skizzierter Kundenvorgabe erstellt Lightnet technische Zeichnung der gewünschten Struktur zur Prüfung und Freigabe. Maximale Flexibilität ermöglicht nahezu 100%ige Umsetzung von kundenseitiger Entwurfsskizze in Produktionszeichnung. Leuchtenkörper mit feinen Radien aus Alumi-

niumprofil mit 60mm Profildbreite, gefertigt aus einem Guss ohne sichtbare Nahtstellen an den Stirnseiten. Oberfläche weiß, silber, graphit, schwarz, champagner oder kupferfarben lackiert. Weitere Oberflächenoptionen siehe Lightnet-Surface-Collection oder RAL nach Wahl. Microprismenoptik mit optimierter Blendungsbegrenzung speziell für Office-Anwendungen. Satinierter Opaldiffusor für Allgemeinbeleuchtung. Konverter wahlweise einfach schaltbar oder stufenlos dimmbar (DALI, Touch-Dim, Casambi). Farbtemperatur 2200K, 2700K, 3000K, 3500K, 4000K oder 6500K. Binning initial \leq MacAdam 3. Farbwiedergabe CRI>80, CRI>90 oder Full Spectrum. Stufenlos höhenverstellbare Seilabhängung mit transparent ummantelter Zuleitung. Lackierung Baldachin passend Leuchtenkörper.

Linear Modules

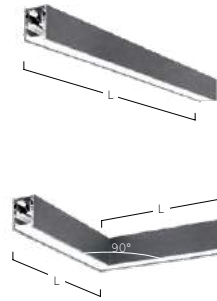

Linear Line

L[mm]	600	888	1178	1472	2340
-------	-----	-----	------	------	------

Sharp Corner

L[mm]	500
-------	-----

Curve Modules



CH 1/2 Curve

R[mm]	500	750	1000
L[mm]	1570	2355	3140



CQ 1/4 Curve

R[mm]	500	750	1000	1250	1500	1750	2000
L[mm]	785	1178	1571	1964	2356	2749	3142



CE 1/8 Curve

R[mm]	1000	1500	2000	2500	3000	3500	4000
L[mm]	785	1178	1571	1964	2356	2749	3142

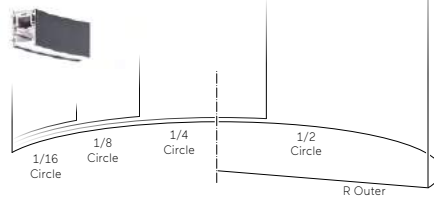

CS 1/16 Curve

R[mm]	2000	3000	3500
L[mm]	785	1178	1374

EN LED pendant light system. Direct-indirect or direct-only light distribution. Highly flexible system consisting of linear elements, vertically and horizontally curved elements and Y- and X-connectors. Each module is designed as a stand-alone luminaire with an integrated driver and can be connected to the other modules using an innovative connector system to create any desired lighting structure. Millimetre-precise manufacturing as well as bespoke curves possible in small quantities thanks to intelligent software-based production system. Based on customer specification, Lightnet creates technical drawings of the desired structure for review and approval. Luminaire body with smooth bends made of 60mm aluminium profile, crafted

in one piece with no visible seams at the ends. Standard colour finishes, white, silver, graphite, black, champagne or copper coated. For further surface options see Lightnet-Surface-Collection or RAL of your choice. Microprismatic screen with optimized glare reduction especially for workplaces. Satin opal diffuser for general lighting. Driver can be switchable or dimmable (DALI, Touch-Dim, Casambi). Colour temperature 2200K, 2700K, 3000K, 3500K, 4000K or 6500K. Binning ≤ MacAdam 3. Colour rendering CRI > 80, CRI > 90 or Full Spectrum. Height-adjustable cord suspension with transparent power supply cable. Colours ceiling rose match to luminaire body.

Bend Modules

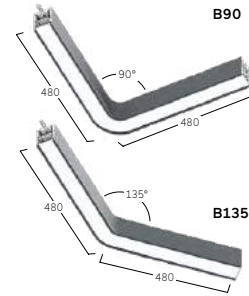
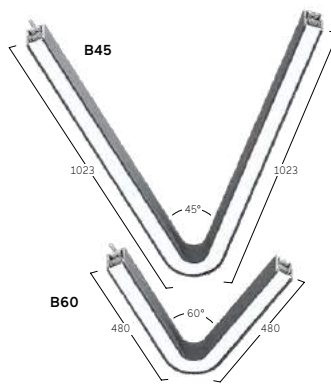

Bend Modules

Type	B45	B60	B90	B135
L[mm]	2046	960	960	960

Wave Modules



WV Concave 1/8 Wave

R[mm]	1000	1250	1500
L[mm]	848	1045	1241



WX Convex 1/8 Wave

R[mm]	1000	1250	1500
L[mm]	848	1045	1241



WV Concave 1/6 Wave

R[mm]	1000	1250	1500
L[mm]	1131	1393	1655

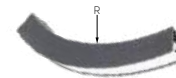

WX Convex 1/6 Wave

R[mm]	1000	1250	1500
L[mm]	1131	1393	1655



WV Concave 1/4 Wave

R[mm]	1000	1250	1500
L[mm]	1696	2089	2482

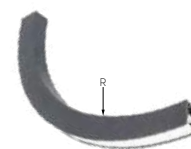

WX Convex 1/4 Wave

R[mm]	1000	1250	1500
L[mm]	1696	2089	2482

X-Junction Modules

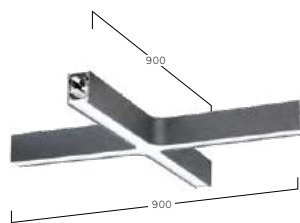

X1-Junction Module

L[mm]	1920
-------	------

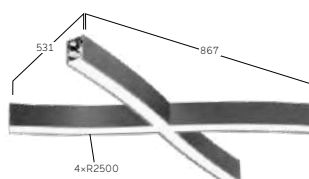

X2-Junction Module

L[mm]	1800
-------	------

Y-Junction Modules

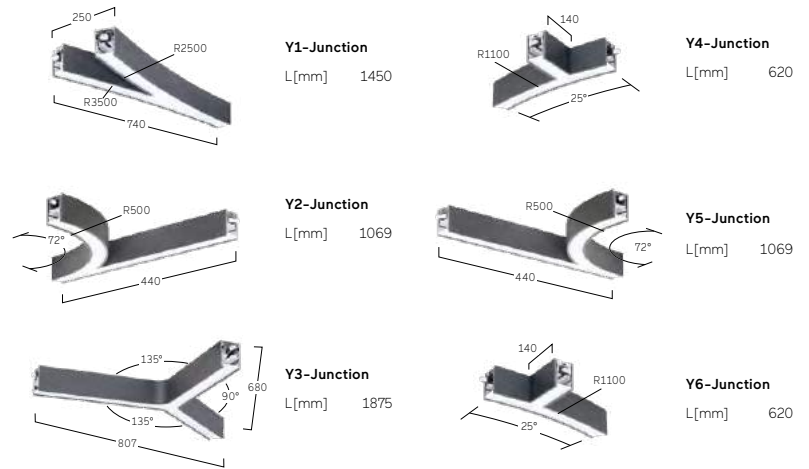

Microprismatic | Direct-Indirect

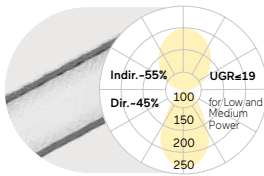

Lumen/Watt Low Power	2670lm/24,0W per m
Lumen/Watt Medium Power	3780lm/35,6W per m
Lumen/Watt High Power	5250lm/50,4W per m

Microprismatic | Direct

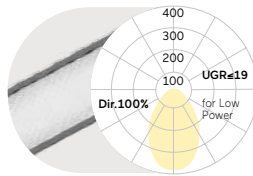

Lumen/Watt Low Power	1200lm/14,6W per m
Lumen/Watt Medium Power	1760lm/22,5W per m
Lumen/Watt High Power	2290lm/30,3W per m

Opal Diffuser | Direct-Indirect

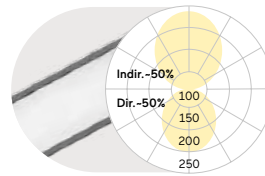

Lumen/Watt Low Power	2770lm/24,0W per m
Lumen/Watt Medium Power	3930lm/35,6W per m
Lumen/Watt High Power	5440lm/50,4W per m

Opal Diffuser | Direct

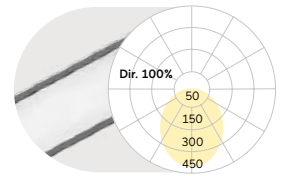

Lumen/Watt Low Power	1300lm/14,6W per m
Lumen/Watt Medium Power	1910lm/22,5W per m
Lumen/Watt High Power	2480lm/30,3W per m

Lumen Values: Luminaire luminous flux at 4000K/CRI>80. Other configurations on request.

Single Cord Suspension:

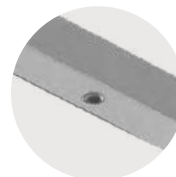
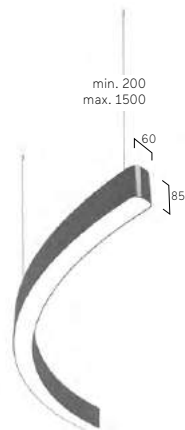

Midpin-Downlight XD
770lm/10W/Ø40mm



Midpin Spotlight XM
770lm/10W/Ø40mm



Midpin Spotlight XP
770lm/10W/Ø40mm



W Snow White

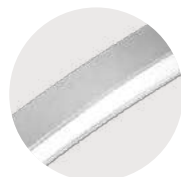

S Radiant Silver



U Urban Graphite



B Jet Black



H Anodic Champagne



K Satin Copper

Code Zero Suspended



Federal Office for Migration and Refugees
Nuremberg, Germany
Code Zero G3
Photography: Alexander Schwarz



Ziegler, Ploßberg, Germany
Code Zero P3



Code Zero Suspended



Architectural Group Bircher Roth von Arx AG
Aarau, Switzerland
Code Zero P3
Realization and photography: Mabalux AG

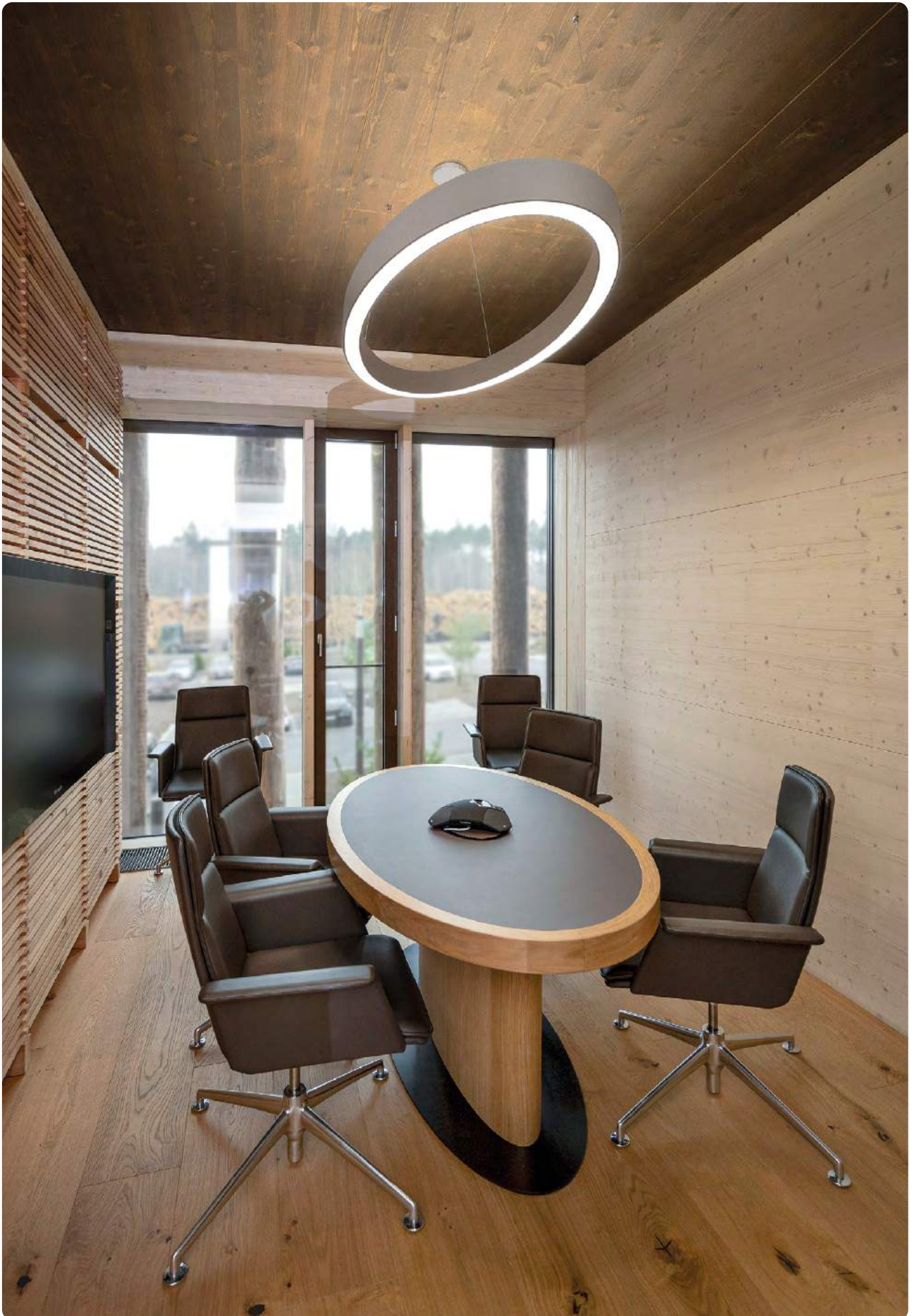

Code Zero G3/P3 | Suspended



DE LED-Pendelleuchte. Direkt-indirekt oder rein direktstrahlend. Leuchtenkörper aus elliptisch geformtem Aluminiumprofil mit 60mm Profilbreite. Erhältlich in 3 Größen, Proportion Länge zu Breite 2:1. Oberfläche weiß, silber, graphit, schwarz, champagner oder kupferfarben lackiert. Weitere Oberflächenoptionen siehe Lightnet-Surface-Collection oder RAL nach Wahl. Satinierter Opaldiffusor für Allgemeinbeleuchtung. Konverter in Leuchtgehäuse integriert, wahlweise einfach schaltbar oder stufenlos dimmbar (DALI, Touch-Dim, Casambi). Farbtemperatur 2200K, 2700K, 3000K, 3500K, 4000K oder 6500K. Binning initial \leq MacAdam 3. Farbwiedergabe CRI $>$ 80, CRI $>$ 90 oder Full Spectrum. Stufenlos höhenverstellbare Parallel-Seilabhängung mit transparent ummantelter Zuleitung. Lackierung Baldachin passend Leuchtenkörper.

EN LED pendant luminaire. Direct-indirect or direct-only light distribution. Luminaire body made of elliptically shaped aluminium profile with 60mm profile width. Available in 3 sizes, length to width ratio 2:1. Surface white, silver, graphite, black, champagne or copper coated. Further surface options see Lightnet-Surface-Collection or RAL of your choice. Satin opal diffuser for general lighting. Driver integrated into luminaire housing, optionally switchable or dimmable (DALI, Touch-Dim, Casambi). Colour temperature 2200K, 2700K, 3000K, 3500K, 4000K or 6500K. Binning \leq MacAdam 3. Colour rendering CRI $>$ 80, CRI $>$ 90 or Full Spectrum. Height-adjustable parallel cord suspension with transparent power supply cable. Colours ceiling rose match to luminaire body.

Z P3 O S L-8 30 M-L1500-K

Product Family	Z: Code Zero
Type	P3: Direct-Indirect, G3: Direct only
Optical System	O: Opal Diffuser
Surface Finish	W: Snow White, V: Ivory White, S: Radiant Silver, U: Urban Graphite, B: Jet Black, H: Anodic Champagne, K: Satin Copper
Control Gear	E: On/Off, L: DALI, C: Casambi, H: Touch-Dim
Colour Rendering	8: CRI>80, 9: CRI>90, F: Full Spectrum [except 2200K]
Colour Temperature	22: 2200K, 27: 2700K, 30: 3000K, 35: 3500K, 40: 4000K, 65: 6500K
Power	M: Medium Power, H: High Power
Size	Luminaire Length in mm: L1500, L2000, L3000
Suspension	K: Parallel Suspension
On Request	Midpin Spotlights



Opal Diffuser | Direct-Indirect

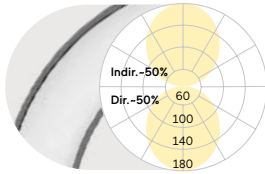

Opal Diffuser | Direct

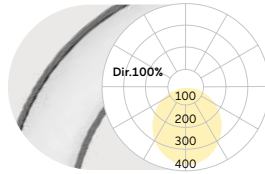

L mm	Lumen/Watt		L mm	Lumen/Watt	
	Medium Power	High Power		Medium Power	High Power
1500	12830lm/120W	18090lm/171W	1500	6550lm/78W	8420lm/104W
2000	17070lm/158W	23970lm/224W	2000	9070lm/106W	11660lm/141W
3000	25030lm/238W	35070lm/338W	3000	13610lm/161W	17490lm/216W

Lumen Values: Luminarie luminous flux at 4000K/CRI>80. Other configurations on request.

Parallel Suspension

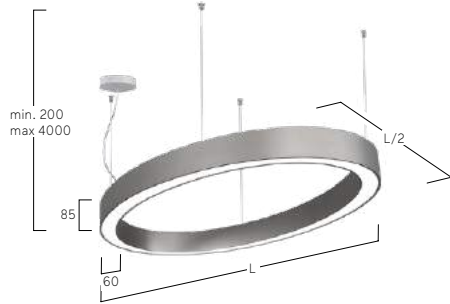

Midpin Spotlight XP
770lm/10W/Ø40mm



W Snow White



S Radiant Silver



U Urban Graphite



B Jet Black



H Anodic Champagne



K Satin Copper

Caleo Inverse GX/PX | System 40mm Suspended



DE LED-Pendelleuchte. Direkt-indirekt oder rein direktstrahlend. Leuchtenkörper aus Aluminiumprofil mit 40mm Profildbreite. Im Standard erhältlich in 3 unterschiedlichen Größen. Oberfläche weiß, silber, graphit, schwarz, champagner oder kupferfarben lackiert. Weitere Oberflächenoptionen siehe Lightnet-Surface-Collection oder RAL nach Wahl. Direktanteil über Präzisionslinsen mit Abblenderaster für breite rotationssymmetrische Lichtstärkeverteilung bei gleichzeitig hoher Blendungsbegrenzung (UGR<19) speziell für Office Anwendungen. Abblenderaster in verschiedenen Farbkombinationen erhältlich. Satinierter Opaldiffusor für Allgemeinbeleuchtung mit max. Transmissionsgrad und homogener Lichtpunktauflösung. Konverter in Leuchtgehäuse integriert, wahlweise einfach schaltbar oder stufenlos dimmbar (DALI, Touch-Dim, Casambi). Farbtemperatur 2200K, 2700K, 3000K, 3500K, 4000K oder 6500K. Binning initial \leq MacAdam 3. Farbwiedergabe CRI>80, CRI>90 oder Full Spectrum. Stufenlos höhenverstellbare Parallel-Seilabhängung mit transparent ummantelter Zuleitung. Lackierung Baldachin passend Leuchtenkörper. Auf Anfrage: Integration von Notlichtkomponenten, Midpin Spotlights.

EN LED pendant luminaire. Direct-indirect or direct-only light distribution. Luminaire body made of 40mm wide aluminium profile. As standard available in 3 different sizes. Surface white, silver, graphite, black, champagne or copper coated. For further surface options see Lightnet-Surface-Collection or RAL of your choice. Direct light with precision lenses with louvre for wide uniform symmetrical light distribution with high glare limitation (UGR<19) especially for workplaces. Louvre available in various colour finishes. Satin opal diffuser for general lighting with maximum transmittance and homogeneous lighting. Driver integrated into luminaire housing, optionally switchable or dimmable (DALI, Touch-Dim, Casambi). Colour temperature 2200K, 2700K, 3000K, 3500K, 4000K or 6500K. Binning \leq MacAdam 3. Colour rendering CRI>80, CRI>90 or Full Spectrum. Height-adjustable parallel cord suspension with transparent power supply cable. Colours ceiling rose match to luminaire body. On request: Integration of emergency lighting components, Midpin spotlights.

APX LWE-8 30 E-Q640-KB*

Product Family	A: Caleo
Type	GX: Direct only, PX: Direct-Indirect
Optical System	C: Opal Flex Diffuser, L: Lens Louvre*
Surface Finish	W: Snow White, V: Ivory White, A: Satin Silver, S: Radiant Silver, U: Urban Graphite, B: Jet Black, H: Anodic Champagne, K: Satin Copper
Control Gear	E: On/Off, L: DALI, C: Casambi, H: Touch-Dim
Colour Rendering	8: CRI>80, 9: CRI>90, F: Full Spectrum [except 2200K]
Colour Temperature	22: 2200K, 27: 2700K, 30: 3000K, 35: 3500K, 40: 4000K, 65: 6500K
Power	E: Low Power, M: Medium Power, H: High Power
Size	Square Size in mm: Q640, Q900, Q1170
Suspension	K: Parallel Suspension
Lens Louvre*	W: Snow White, A: Satin Silver, B: Jet Black, H: Anodic Champagne, K: Satin Copper, G: Satin Gold
On Request	Midpin Spotlights, Acoustic Absorber



Lens Louvre Direct-Indirect			Lens Louvre Direct			Opal Flex Diffuser Direct-Indirect			Opal Flex Diffuser Direct		
Q	Lumen/Watt	Lumen/Watt	Q	Lumen/Watt	Lumen/Watt	Q	Lumen/Watt	Lumen/Watt	Q	Lumen/Watt	Lumen/Watt
mm	Low Power	Medium Power	mm	Low Power	High Power	mm	Low Power	Medium Power	mm	Medium Power	High Power
640	6490lm/50W	9250lm/74W	640	3480lm/27W	6380lm/54W	640	5230lm/47W	7480lm/69W	640	3190lm/34W	4460lm/50W
900	9690lm/74W	13880lm/109W	900	5220lm/39W	9580lm/78W	900	7880lm/70W	11150lm/101W	900	4710lm/49W	6630lm/72W
1170	12910lm/97W	18510lm/145W	1170	6960lm/51W	12770lm/104W	1170	10500lm/92W	14870lm/133W	1170	6280lm/64W	8840lm/95W

Lumen Values: Luminaire luminous flux at 4000K/CRI>80. Other configurations on request.

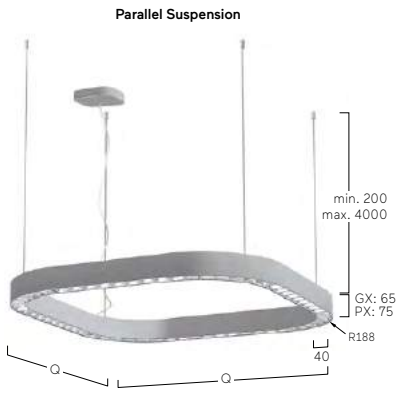

Midpin Spotlight XP
770lm/10W/Ø40mm



Caleo Neo G4/P4 | Suspended



DE LED-Pendelleuchte. Direkt-indirekt oder rein direktstrahlend. Gestufter Leuchtenkörper aus Aluminiumprofil mit lediglich 25mm sichtbarem Rahmenprofil. Gehäuse-Außenfläche und Innendekor in unterschiedlichen Lackierungen und Kombinationen erhältlich, z.B. weiß, silber, graphit, schwarz, gold oder kupferfarben. Zu Oberflächenoptionen- und Kombinationen siehe Lightnet-Surface-Collection oder Bi-Colour-Auswahl. Rückversetzte Microprismenoptik mit optimierter Blendungsbegrenzung speziell für Office-Anwendungen. Satiniertes Opaldiffusor für Allgemeinbeleuchtung mit max. Transmissionsgrad und homogener Lichtpunktauflösung. Konverter in Leuchtgehäuse integriert, wahlweise einfach schaltbar oder stufenlos dimmbar (DALI, Touch-Dim, Casambi). Farbtemperatur 2200K, 2700K, 3000K, 3500K, 4000K oder 6500K. Binning initial \leq MacAdam 3. Farbwiedergabe CRI>80, CRI>90 oder Full Spectrum. Stufenlos höhenverstellbare Parallel- oder Y-Seilabhängung mit transparent ummantelter Zuleitung oder Pendelrohrabhängung. Lackierung Baldachin passend Leuchtenkörper. Auf Anfrage: Integration von Notlichtkomponenten.

EN LED pendant luminaire. Direct-indirect or direct-only light distribution. Tiered luminaire body made of aluminium profile with 25mm visible trim. Outer housing and inner decorative trim available in various finishes and combinations, e.g. white, silver, graphite, black, gold or copper coated. For surface options and combinations check Lightnet Surface Collection or Bi-Colour Selection. Recessed microprismatic screen with optimized glare reduction especially for workplaces. Satin opal diffuser for general lighting with maximum transmittance and homogeneous lighting. Driver integrated into luminaire housing, optionally switchable or dimmable (DALI, Touch-Dim, Casambi). Colour temperature 2200K, 2700K, 3000K, 3500K, 4000K or 6500K. Binning \leq MacAdam 3. Colour rendering CRI>80, CRI>90 or Full Spectrum. Height-adjustable parallel or Y-cord suspension with transparent power supply cable or rod suspension. Colours ceiling rose match to luminaire body. On request: Integration of emergency lighting components.

A P4 A WE - 8 30 M - L900 - KG

- Product Family **A:** Caleo
- Type **G4:** Direct only, **P4:** Direct-Indirect
- Optical System **A:** Microprismatic, **O:** Opal Diffuser
- Surface Finish **W:** Snow White, **V:** Ivory White, **S:** Radiant Silver, **U:** Urban Graphite, **B:** Jet Black, **H:** Anodic Champagne, **K:** Satin Copper
- Control Gear **E:** On/Off, **L:** DALI, **H:** Touch-Dim, **C:** Casambi
- Colour Rendering **8:** CRI>80, **9:** CRI>90, **F:** Full Spectrum [except 2200K]
- Colour Temperature **22:** 2200K, **27:** 2700K, **30:** 3000K, **35:** 3500K, **40:** 4000K, **65:** 6500K
- Power **M:** Medium Power, **H:** High Power
- Size Luminaire Length in mm: **L900, L1200, L1500**
- Suspension **K:** Parallel Suspension, **Y:** Y-Cord Suspension, **P:** Tube Suspension
- Reflector **W:** Snow White, **V:** Ivory White, **A:** Satin Silver, **U:** Urban Graphite, **B:** Jet Black, **H:** Anodic Champagne, **K:** Satin Copper, **G:** Satin Gold



Microprismatic | Direct-Indirect

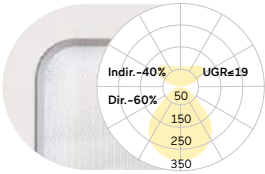

L mm	Lumen/Watt Medium Power	Lumen/Watt High Power
900	3760lm/31W	5070lm/40W
1200	5010lm/39W	6810lm/52W
1500	6480lm/49W	8450lm/65W

Microprismatic | Direct

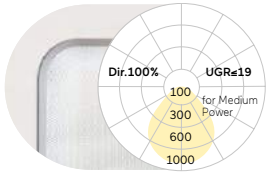

L mm	Lumen/Watt Medium Power	Lumen/Watt High Power
900	2280lm/19W	3150lm/27W
1200	3040lm/24W	4260lm/34W
1500	4020lm/32W	5260lm/42W

Opal Diffuser | Direct-Indirect

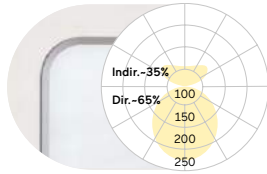

L mm	Lumen/Watt Medium Power	Lumen/Watt High Power
900	3860lm/31W	5210lm/40W
1200	5140lm/39W	6930lm/52W
1500	6610lm/49W	8660lm/65W

Opal Diffuser | Direct

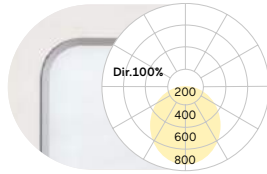

L mm	Lumen/Watt Medium Power	Lumen/Watt High Power
900	2380lm/19W	3290lm/27W
1200	3170lm/24W	4380lm/34W
1500	4150lm/32W	5470lm/42W

Lumen Values: Luminaire luminous flux at 4000K/CRI>80. Other configurations on request.

Parallel Suspension

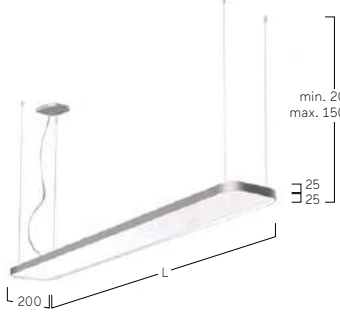

Y-Cord Suspension

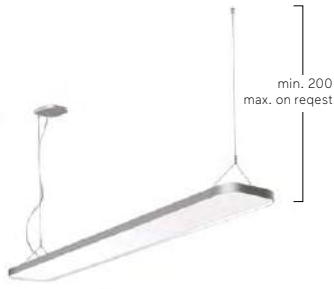

Tube Suspension



W Snow White
W Snow White



W Snow White
A Satin Silver



W Snow White
B Jet Black



W Snow White
G Satin Gold



W Snow White
H Anodic Champagne



W Snow White
K Satin Copper

Caleo Neo Square Suspended



Mercedes Sales Point, Hof, Germany
Caleo G2, Special Version



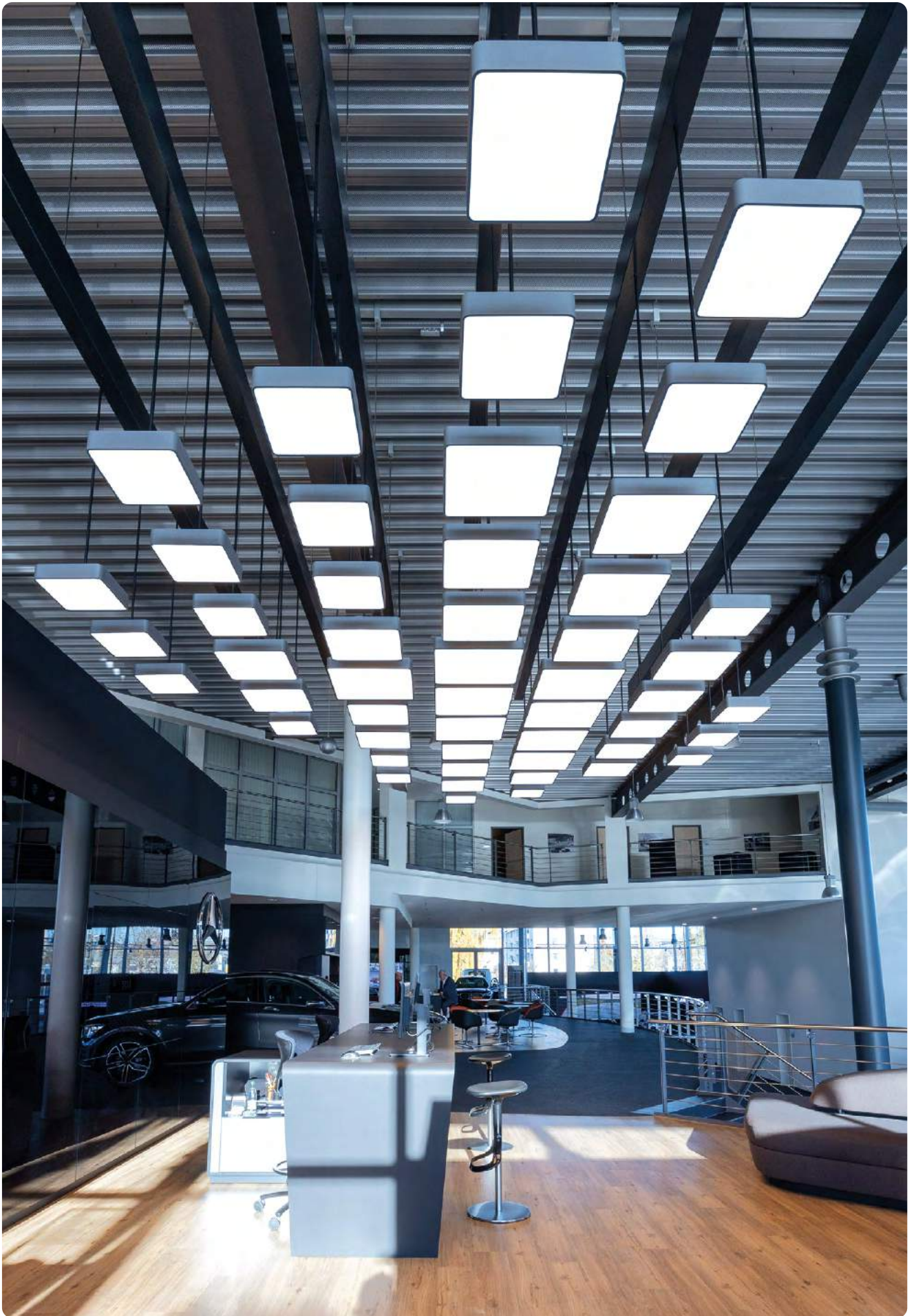

Caleo Neo G6/P6 | Suspended



DE LED-Pendelleuchte. Direkt-indirekt oder rein direktstrahlend. Gestufter Leuchtenkörper aus Aluminiumprofil mit lediglich 25mm sichtbarem Rahmenprofil. Gehäuse-Außenfläche und dekorativer Reflektorring in unterschiedlichen Lackierungen und Kombinationen erhältlich, z.B. weiß, silber, graphit, schwarz, gold oder kupferfarben. Zu Oberflächenoptionen- und Kombinationen siehe Lightnet-Surface-Collection oder Bi-Colour-Auswahl. Rückversetzte Microprismenoptik mit optimierter Blendungsbegrenzung speziell für Office-Anwendungen. Satinierter Opaldiffusor für Allgemeinbeleuchtung mit max. Transmissionsgrad und homogener Lichtpunktauflösung. Konverter in Leuchtengehäuse integriert, wahlweise einfach schaltbar oder stufenlos dimmbar (DALI, Touch-Dim, Casambi). Farbtemperatur 2200K, 2700K, 3000K, 3500K, 4000K oder 6500K. Binning initial \leq MacAdam 3. Farbwiedergabe CRI>80, CRI>90 oder Full Spectrum. Stufenlos höhenverstellbare Parallelseil-Abhängung mit transparent ummantelter Zuleitung oder Pendelrohrabhängung. Lackierung Baldachin passend Leuchtenkörper. Auf Anfrage: Integration von Notlichtkomponenten.

EN LED pendant luminaire. Direct-indirect or direct-only light distribution. Tiered luminaire body made of aluminium profile with 25mm visible trim. Outer housing and decorative trim available in various finishes and combinations, e.g. white, silver, graphite, black, gold or copper coated. For further surface options and combinations check Lightnet Surface Collection or Bi-Colour Selection. Recessed microprismatic screen with optimized glare reduction especially for workplaces. Satin opal diffuser for general lighting with maximum transmittance and homogeneous lighting. Driver integrated into luminaire housing, optionally switchable or dimmable (DALI, Touch-Dim, Casambi). Colour temperature 2200K, 2700K, 3000K, 3500K, 4000K or 6500K. Binning \leq MacAdam 3. Colour rendering CRI>80, CRI>90 or Full Spectrum. Height-adjustable parallel cord suspension with transparent power supply cable or rod suspension. Colours ceiling rose match to luminaire body. On request: Integration of emergency lighting components.

A P6 A WE-8 30 M-Q300-KG

- Product Family **A:** Caleo
- Type **G6:** Direct only, **P6:** Direct-Indirect
- Optical System **A:** Microprismatic, **O:** Opal Diffuser
- Surface Finish **W:** Snow White, **V:** Ivory White, **S:** Radiant Silver, **U:** Urban Graphite, **B:** Jet Black, **H:** Anodic Champagne, **K:** Satin Copper
- Control Gear **E:** On/Off, **L:** DALI, **H:** Touch-Dim, **C:** Casambi
- Colour Rendering **8:** CRI>80, **9:** CRI>90, **F:** Full Spectrum [except 2200K]
- Colour Temperature **22:** 2200K, **27:** 2700K, **30:** 3000K, **35:** 3500K, **40:** 4000K, **65:** 6500K
- Power **M:** Medium Power, **H:** High Power
- Size Square Size in mm: **Q300, Q400, Q500, Q600**
- Suspension **K:** Parallel Suspension, **P:** Tube Suspension [Q400-Q600]
- Reflector **W:** Snow White, **V:** Ivory White, **A:** Satin Silver, **U:** Urban Graphite, **B:** Jet Black, **H:** Anodic Champagne, **K:** Satin Copper, **G:** Satin Gold



Microprismatic Direct-Indirect			Microprismatic Direct			Opal Diffuser Direct-Indirect			Opal Diffuser Direct																																																										
				<table border="1"> <thead> <tr> <th>Q mm</th> <th>Lumen/Watt Medium Power</th> <th>Lumen/Watt High Power</th> </tr> </thead> <tbody> <tr><td>300</td><td>1990lm/17W</td><td>2700lm/22W</td></tr> <tr><td>400</td><td>2930lm/23W</td><td>3890lm/31W</td></tr> <tr><td>500</td><td>5140lm/39W</td><td>6720lm/52W</td></tr> <tr><td>600</td><td>6790lm/54W</td><td>9230lm/73W</td></tr> </tbody> </table>	Q mm	Lumen/Watt Medium Power	Lumen/Watt High Power	300	1990lm/17W	2700lm/22W	400	2930lm/23W	3890lm/31W	500	5140lm/39W	6720lm/52W	600	6790lm/54W	9230lm/73W	<table border="1"> <thead> <tr> <th>Q mm</th> <th>Lumen/Watt Medium Power</th> <th>Lumen/Watt High Power</th> </tr> </thead> <tbody> <tr><td>300</td><td>1230lm/11W</td><td>1670lm/15W</td></tr> <tr><td>400</td><td>2060lm/18W</td><td>2720lm/23W</td></tr> <tr><td>500</td><td>3180lm/26W</td><td>4180lm/35W</td></tr> <tr><td>600</td><td>4800lm/39W</td><td>6480lm/53W</td></tr> </tbody> </table>	Q mm	Lumen/Watt Medium Power	Lumen/Watt High Power	300	1230lm/11W	1670lm/15W	400	2060lm/18W	2720lm/23W	500	3180lm/26W	4180lm/35W	600	4800lm/39W	6480lm/53W	<table border="1"> <thead> <tr> <th>Q mm</th> <th>Lumen/Watt Medium Power</th> <th>Lumen/Watt High Power</th> </tr> </thead> <tbody> <tr><td>300</td><td>2000lm/17W</td><td>2720lm/22W</td></tr> <tr><td>400</td><td>2950lm/23W</td><td>3910lm/31W</td></tr> <tr><td>500</td><td>5170lm/39W</td><td>6760lm/52W</td></tr> <tr><td>600</td><td>6830lm/54W</td><td>9290lm/73W</td></tr> </tbody> </table>	Q mm	Lumen/Watt Medium Power	Lumen/Watt High Power	300	2000lm/17W	2720lm/22W	400	2950lm/23W	3910lm/31W	500	5170lm/39W	6760lm/52W	600	6830lm/54W	9290lm/73W	<table border="1"> <thead> <tr> <th>Q mm</th> <th>Lumen/Watt Medium Power</th> <th>Lumen/Watt High Power</th> </tr> </thead> <tbody> <tr><td>300</td><td>1240lm/11W</td><td>1690lm/15W</td></tr> <tr><td>400</td><td>2080lm/18W</td><td>2740lm/23W</td></tr> <tr><td>500</td><td>3210lm/26W</td><td>4220lm/35W</td></tr> <tr><td>600</td><td>4840lm/39W</td><td>6540lm/53W</td></tr> </tbody> </table>	Q mm	Lumen/Watt Medium Power	Lumen/Watt High Power	300	1240lm/11W	1690lm/15W	400	2080lm/18W	2740lm/23W	500	3210lm/26W	4220lm/35W	600	4840lm/39W	6540lm/53W
Q mm	Lumen/Watt Medium Power	Lumen/Watt High Power																																																																	
300	1990lm/17W	2700lm/22W																																																																	
400	2930lm/23W	3890lm/31W																																																																	
500	5140lm/39W	6720lm/52W																																																																	
600	6790lm/54W	9230lm/73W																																																																	
Q mm	Lumen/Watt Medium Power	Lumen/Watt High Power																																																																	
300	1230lm/11W	1670lm/15W																																																																	
400	2060lm/18W	2720lm/23W																																																																	
500	3180lm/26W	4180lm/35W																																																																	
600	4800lm/39W	6480lm/53W																																																																	
Q mm	Lumen/Watt Medium Power	Lumen/Watt High Power																																																																	
300	2000lm/17W	2720lm/22W																																																																	
400	2950lm/23W	3910lm/31W																																																																	
500	5170lm/39W	6760lm/52W																																																																	
600	6830lm/54W	9290lm/73W																																																																	
Q mm	Lumen/Watt Medium Power	Lumen/Watt High Power																																																																	
300	1240lm/11W	1690lm/15W																																																																	
400	2080lm/18W	2740lm/23W																																																																	
500	3210lm/26W	4220lm/35W																																																																	
600	4840lm/39W	6540lm/53W																																																																	

Lumen Values: Luminaire luminous flux at 4000K/CRI>80. Other configurations on request.

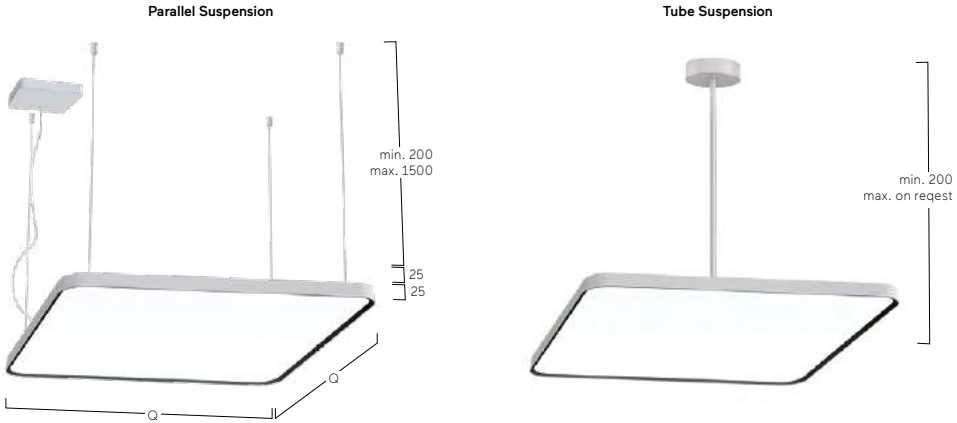

Cubic Suspended

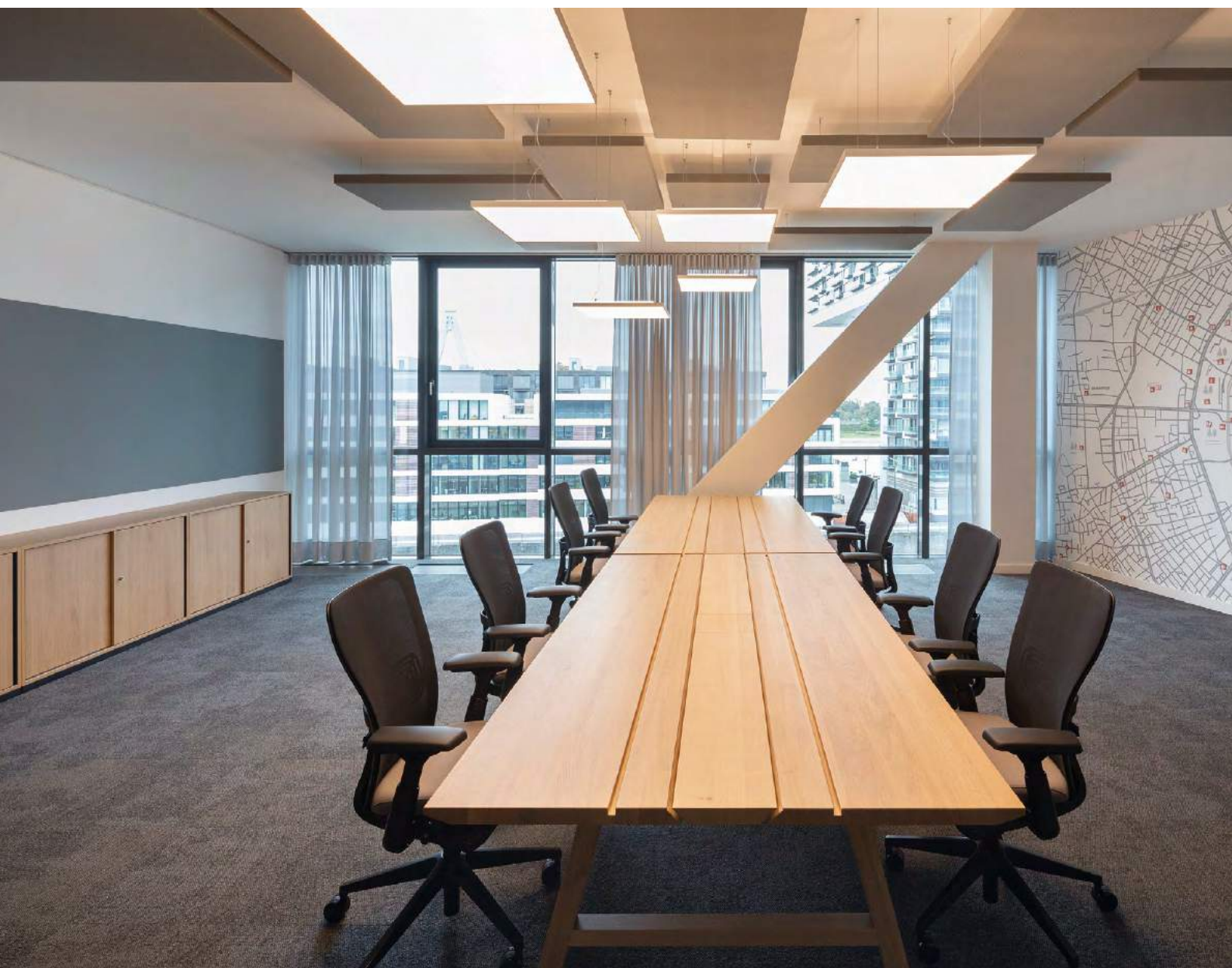

Microsoft, Cologne, Germany

Cubic P6

Photography: HGEsch, Planning: corinna arens
and dorette faulhaber, Lepel & Lepel architects



Inwerk – Office Culture Forum
Meerbusch, Germany
Cubic G4
Photography: Tomas Rodriguez

Cubic Evolution G4/P4 | 200mm Suspended



DE LED-Pendelleuchte. Direkt-indirekt oder rein direktstrahlend. Leuchtenkörper in minimalistischer Bauhöhe aus Aluminiumprofil. Oberfläche natur-eloxiert oder weiß, graphit, schwarz bzw. champagnerfarben lackiert. Weitere Oberflächenoptionen siehe Lightnet-Surface-Collection oder RAL nach Wahl. Microprismenoptik mit optimierter Blendungsbegrenzung speziell für Office-Anwendungen. Satinierter Opaldiffusor für Allgemeinbeleuchtung mit max. Transmissionsgrad und homogener Lichtpunktauflösung. Konverter in Leuchtengehäuse integriert, wahlweise einfach schaltbar oder stufenlos dimmbar (DALI, Touch-Dim, Casambi). Farbtemperatur 2200K, 2700K, 3000K, 3500K, 4000K, 6500K oder Tunable White (2700-6500K). Binning initial \leq MacAdam 3. Farbwiedergabe CRI $>$ 80, CRI $>$ 90 oder Full Spectrum. Stufenlos höhenverstellbare Parallel- oder Y-Seilabhängung mit transparent ummantelter Zuleitung oder Pendelrohrabhängung. Lackierung Baldachin passend Leuchtenkörper. Auf Anfrage: Integration von Notlichtkomponenten, Sensortechnologie.

EN LED pendant luminaire. Direct-indirect or direct-only light distribution. Luminaire body with minimalistic overall height made of aluminium profile. Surface natural anodised or white, graphite, black or champagne coated. Further surface options see Lightnet-Surface-Collection or RAL of your choice. Microprismatic screen with optimized glare reduction especially for workplaces. Satin opal diffuser for general lighting with maximum transmittance and homogeneous lighting. Driver integrated into luminaire housing, optionally switchable or dimmable (DALI, Touch-Dim, Casambi). Colour temperature 2200K, 2700K, 3000K, 3500K, 4000K, 6500K or Tunable White (2700-6500K). Binning \leq MacAdam 3. Colour rendering CRI $>$ 80, CRI $>$ 90 or Full Spectrum. Height-adjustable parallel or Y-cord suspension with transparent power supply cable or rod suspension. Colour of ceiling rose matching luminaire body. On request: Integration of emergency lighting components, sensor technology.

C P4 A B E-8 30 M-L900-Y

- Product Family **C:** Cubic
- Type **G4:** Direct only, **P4:** Direct-Indirect
- Optical System **A:** Microprismatic, **O:** Opal Diffuser
- Surface Finish **W:** Snow White, **E:** Silver Anodised, **U:** Urban Graphite, **B:** Jet Black, **H:** Anodic Champagne
- Control Gear **E:** On/Off, **L:** DALI, **H:** Touch-Dim, **C:** Casambi, **6:** DALI DT6 for TW, **8:** DALI DT8 for TW
- Colour Rendering **8:** CRI>80, **9:** CRI>90, **F:** Full Spectrum [except 2200K]
- Colour Temperature **22:** 2200K, **27:** 2700K, **30:** 3000K, **35:** 3500K, **40:** 4000K, **65:** 6500K, **TW:** Tunable White 2700-6500K
- Power **M:** Medium Power, **H:** High Power
- Size Luminaire Length in mm: **L900, L1200, L1500**
- Suspension **K:** Parallel Suspension, **Y:** Y-Cord Suspension, **P:** Tube Suspension
- On Request Emergency Module [L1200-L1500], Multisensor



Microprismatic Direct-Indirect			Microprismatic Direct			Opal Diffuser Direct-Indirect			Opal Diffuser Direct		
L mm	Lumen/Watt Medium Power	Lumen/Watt High Power	L mm	Lumen/Watt Medium Power	Lumen/Watt High Power	L mm	Lumen/Watt Medium Power	Lumen/Watt High Power	L mm	Lumen/Watt Medium Power	Lumen/Watt High Power
900	3790lm/30W	5000lm/40W	900	2280lm/21W	2930lm/26W	900	3750lm/30W	4950lm/40W	900	2170lm/21W	2730lm/26W
1200	5020lm/39W	6560lm/52W	1200	3050lm/27W	3900lm/34W	1200	4930lm/39W	6510lm/52W	1200	2890lm/27W	3650lm/34W
1500	6160lm/48W	8270lm/65W	1500	3700lm/32W	4880lm/43W	1500	6090lm/48W	8160lm/65W	1500	3460lm/32W	4560lm/43W

Lumen Values: Luminaire luminous flux at 4000K/CRI>80. Other configurations on request.

Parallel Suspension:

Y-Cord Suspension:

Tube Suspension:

Multisensor

Emergency Module

W Snow White

E Silver Anodised

U Urban Graphite

B Jet Black

H Anodic Champagne

Cubic Evolution G5/P5 | 300mm Suspended



DE LED-Pendelleuchte. Direkt-indirekt oder rein direktstrahlend. Leuchtenkörper in minimalistischer Bauhöhe aus Aluminiumprofil. Oberfläche natur-eloxiert oder weiß, graphit, schwarz bzw. champagnerfarben lackiert. Weitere Oberflächenoptionen siehe Lightnet-Surface-Collection oder RAL nach Wahl. Microprismenoptik mit optimierter Blendungsbegrenzung speziell für Office-Anwendungen. Satinierter Opaldiffusor für Allgemeinbeleuchtung mit max. Transmissionsgrad und homogener Lichtpunktauflösung. Konverter in Leuchtengehäuse integriert, wahlweise einfach schaltbar oder stufenlos dimmbar (DALI, Touch-Dim, Casambi). Farbtemperatur 2200K, 2700K, 3000K, 3500K, 4000K, 6500K oder Tunable White (2700-6500K). Binning initial \leq MacAdam 3. Farbwiedergabe CRI $>$ 80, CRI $>$ 90 oder Full Spectrum. Stufenlos höhenverstellbare Parallel- oder Y-Seilabhängung mit transparent ummantelter Zuleitung. Lackierung Baldachin passend Leuchtenkörper. Auf Anfrage: Integration von Notlichtkomponenten, Sensortechnologie.

EN LED pendant luminaire. Direct-indirect or direct-only light distribution. Luminaire body with slim overall height made of aluminium profile. Surface natural anodised or white, graphite, black or champagne coated. Further surface options see Lightnet-Surface-Collection or RAL of your choice. Microprismatic screen with optimized glare reduction especially for workplaces. Satin opal diffuser for general lighting with maximum transmittance and homogeneous lighting. Driver integrated into luminaire housing, optionally switchable or dimmable (DALI, Touch-Dim, Casambi). Colour temperature 2200K, 2700K, 3000K, 3500K, 4000K, 6500K or Tunable White (2700-6500K). Binning \leq MacAdam 3. Colour rendering CRI $>$ 80, CRI $>$ 90 or Full Spectrum. Height-adjustable parallel or Y-cord suspension with transparent power supply cable. Colours ceiling rose match to luminaire body. On request: Integration of emergency lighting components, sensor technology.

C P5 A B E-8 30 M-L900-Y

- Product Family **C:** Cubic
- Type **G5:** Direct only, **P5:** Direct-Indirect
- Optical System **A:** Microprismatic, **O:** Opal Diffuser
- Surface Finish **W:** Snow White, **E:** Silver Anodised, **U:** Urban Graphite, **B:** Jet Black, **H:** Anodic Champagne
- Control Gear **E:** On/Off, **L:** DALI, **H:** Touch-Dim, **C:** Casambi, **6:** DALI DT6 for TW, **8:** DALI DT8 for TW
- Colour Rendering **8:** CRI>80, **9:** CRI>90, **F:** Full Spectrum [except 2200K]
- Colour Temperature **22:** 2200K, **27:** 2700K, **30:** 3000K, **35:** 3500K, **40:** 4000K, **65:** 6500K, **TW:** Tunable White 2700-6500K
- Power **M:** Medium Power, **H:** High Power
- Size Luminaire Length in mm: **L900, L1200, L1500**
- Suspension **K:** Parallel Suspension, **Y:** Y-Cord Suspension
- On Request Emergency Module, Radar Sensor, Multisensor



Microprismatic | Direct-Indirect

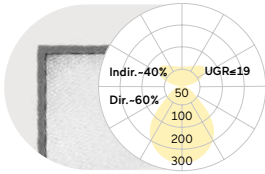

L mm	Lumen/Watt Medium Power	Lumen/Watt High Power
900	5220lm/39W	7430lm/55W
1200	6990lm/51W	9910lm/74W
1500	8590lm/62W	12350lm/91W

Microprismatic | Direct

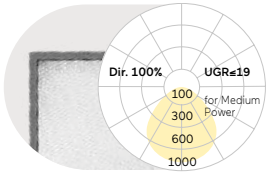

L mm	Lumen/Watt Medium Power	Lumen/Watt High Power
900	3220lm/25W	4600lm/35W
1200	4290lm/33W	6140lm/48W
1500	5370lm/40W	7670lm/59W

Opal Diffuser | Direct-Indirect

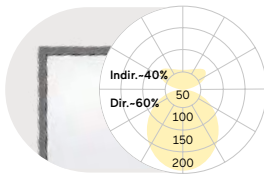

L mm	Lumen/Watt Medium Power	Lumen/Watt High Power
900	5030lm/39W	7140lm/55W
1200	6740lm/51W	9510lm/74W
1500	8270lm/62W	11850lm/91W

Opal Diffuser | Direct

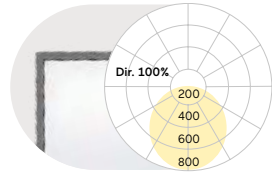

L mm	Lumen/Watt Medium Power	Lumen/Watt High Power
900	3030lm/25W	4310lm/35W
1200	4040lm/33W	5740lm/48W
1500	5050lm/40W	7170lm/59W

Lumen Values: Luminaire luminous flux at 4000K/CRI>80. Other configurations on request.

Parallel Suspension:



Y-Cord Suspension:

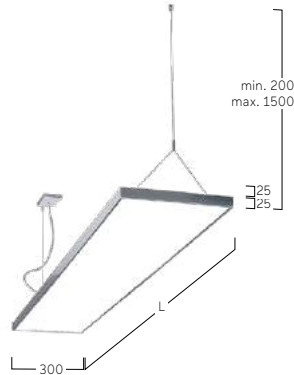

Multisensor



Emergency Module



W Snow White



E Silver Anodised

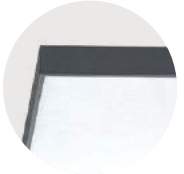

U Urban Graphite



B Jet Black



H Anodic Champagne

Cubic Evolution G6/P6 | Square Suspended



DE LED-Pendelleuchte. Direkt-indirekt oder rein direktstrahlend. Leuchtenkörper in minimalistischer Bauhöhe aus Aluminiumprofil. Oberfläche natur-eloxiert oder weiß, graphit, schwarz bzw. champagnerfarben lackiert. Weitere Oberflächenoptionen siehe Lightnet-Surface-Collection oder RAL nach Wahl. Microprismenoptik mit optimierter Blendungsbegrenzung speziell für Office-Anwendungen. Satinierter Opaldiffusor für Allgemeinbeleuchtung mit max. Transmissionsgrad und homogener Lichtpunktauflösung. Konverter in Leuchtengehäuse integriert, wahlweise einfach schaltbar oder stufenlos dimmbar (DALI, Touch-Dim, Casambi). Farbtemperatur 2200K, 2700K, 3000K, 3500K, 4000K, 6500K oder Tunable White (2700-6500K). Binning initial \leq MacAdam 3. Farbwiedergabe CRI $>$ 80, CRI $>$ 90 oder Full Spectrum. Stufenlos höhenverstellbare Parallelseil-Abhängung mit transparent ummantelter Zuleitung oder Pendelrohrabhängung. Lackierung Baldachin passend Leuchtenkörper. Auf Anfrage: Integration von Notlichtkomponenten, Sensortechnologie.

EN LED pendant luminaire. Direct-indirect or direct-only light distribution. Luminaire body with minimalistic overall height made of aluminium profile. Surface natural anodised or white, graphite, black or champagne coated. Further surface options see Lightnet-Surface-Collection or RAL of your choice. Microprismatic screen with optimized glare reduction especially for workplaces. Satin opal diffuser for general lighting with maximum transmittance and homogeneous lighting. Driver integrated into luminaire housing, optionally switchable or dimmable (DALI, Touch-Dim, Casambi). Colour temperature 2200K, 2700K, 3000K, 3500K, 4000K, 6500K or Tunable White (2700-6500K). Binning \leq MacAdam 3. Colour rendering CRI $>$ 80, CRI $>$ 90 or Full Spectrum. Height-adjustable parallel cord suspension with transparent power supply cable or rod suspension. Colours ceiling rose match to luminaire body. On request: Integration of emergency lighting components, sensor technology.

C P6 A B E-8 30 M-Q600-K

Product Family	C: Cubic
Type	G6: Direct only, P6: Direct-Indirect
Optical System	A: Microprismatic, O: Opal Diffuser
Surface Finish	W: Snow White, E: Silver Anodised, U: Urban Graphite, B: Jet Black, H: Anodic Champagne
Control Gear	E: On/Off, L: DALI, H: Touch-Dim, C: Casambi, 6: DALI DT6 for TW, 8: DALI DT8 for TW
Colour Rendering	8: CRI>80, 9: CRI>90, F: Full Spectrum [except 2200K]
Colour Temperature	22: 2200K, 27: 2700K, 30: 3000K, 35: 3500K, 40: 4000K, 65: 6500K, TW: Tunable White 2700-6500K
Power	M: Medium Power, H: High Power
Size	Square size in mm: Q300, Q400, Q500, Q600, Q800
Suspension	P: Tube Suspension [Q400-Q800], K: Parallel Suspension
On Request	Emergency Module [Q400-Q800], Multisensor [Q400-Q800]



Microprismatic | Direct-Indirect

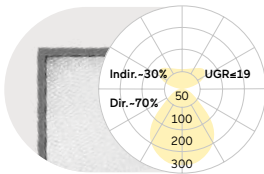

Q	Lumen/Watt	Lumen/Watt
mm	Medium Power	High Power
300	1970lm/16W	2850lm/24W
400	2920lm/23W	4170lm/32W
500	4580lm/33W	5900lm/44W
600	7240lm/55W	9850lm/76W
800	10590lm/76W	14950lm/109W

Microprismatic | Direct

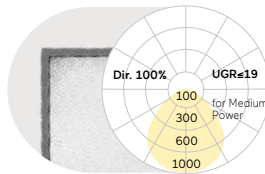

Q	Lumen/Watt	Lumen/Watt
mm	Medium Power	High Power
300	1210lm/11W	1740lm/16W
400	1960lm/16W	2860lm/24W
500	3330lm/26W	4290lm/34W
600	5250lm/40W	7100lm/55W
800	7590lm/55W	10630lm/78W

Opal Diffuser | Direct-Indirect

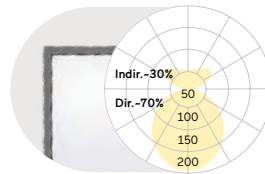

Q	Lumen/Watt	Lumen/Watt
mm	Medium Power	High Power
300	1930lm/16W	2760lm/24W
400	2870lm/23W	4120lm/32W
500	4550lm/33W	5880lm/44W
600	7170lm/55W	9750lm/76W
800	10370lm/76W	14440lm/109W

Opal Diffuser | Direct

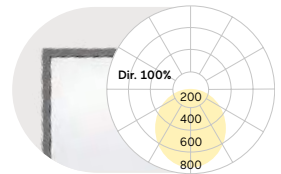

Q	Lumen/Watt	Lumen/Watt
mm	Medium Power	High Power
300	1170lm/11W	1650lm/16W
400	1910lm/16W	2810lm/24W
500	3300lm/26W	4270lm/34W
600	5180lm/40W	7000lm/55W
800	7370lm/55W	10120lm/78W

Lumen Values: Luminaire luminous flux at 4000K/CRI>80. Other configurations on request.

Tube Suspension



Parallel Suspension

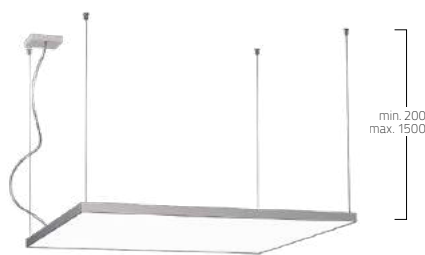

Multisensor



Emergency Module



W Snow White



E Silver Anodised



U Urban Graphite



B Jet Black



H Anodic Champagne

Cubic Evolution System G4/P4 | Suspended



DE LED-System-Pendelleuchte. Direkt-indirekt oder rein direktstrahlend. Leuchtenkörper in minimalistischer Bauhöhe aus Aluminiumprofil. Oberfläche natureloxiiert oder weiß, graphit, schwarz bzw. champagnerfarben lackiert. Weitere Oberflächenoptionen siehe Lightnet-Surface-Collection oder RAL nach Wahl. Microprismenoptik mit optimierter Blendungsbegrenzung speziell für Office-Anwendungen. Satiniertes Opaldiffusor für Allgemeinbeleuchtung mit max. Transmissionsgrad und homogener Lichtpunktauflösung. Konverter in Leuchtengehäuse integriert, wahlweise einfach schaltbar oder stufenlos dimmbar (DALI, Touch-Dim, Casambi). Farbtemperatur 2200K, 2700K, 3000K, 3500K, 4000K, 6500K oder Tunable White (2700-6500K). Binning initial \leq MacAdam 3. Farbwiedergabe $\text{CRI} > 80$, $\text{CRI} > 90$ oder Full Spectrum. Intelligentes System bestehend aus separat zu bestellenden Längsmodulen (Line), Eckmodulen (Corner), Verbindern (Connector), Seilabhängungen (Suspension) und Set Baldachin samt Einspeisung (Canopy + Power Supply) für durchgängige Lichtbänder und kundenspezifische Lichtkonfigurationen. Auf Anfrage: Integration von Notlichtkomponenten, Sensortechnologie.

EN LED pendant light system. Direct-indirect or direct-only light distribution. Luminaire body with minimalistic overall height made of aluminium profile. Surface natural anodised or white, graphite, black or champagne coated. For further surface options see Lightnet-Surface-Collection or RAL of your choice. Microprismatic screen with optimized glare reduction especially for workplaces. Satin opal diffuser for general lighting with maximum transmittance and homogeneous lighting. Driver integrated into luminaire housing, optionally switchable or dimmable (DALI, Touch-Dim, Casambi). Colour temperature 2200K, 2700K, 3000K, 3500K, 4000K, 6500K or Tunable White (2700-6500K). Binning \leq MacAdam 3. Colour rendering $\text{CRI} > 80$, $\text{CRI} > 90$ or Full Spectrum. Intelligent system consisting of linear modules, corner modules, connectors, cord suspensions (Suspension) and set ceiling rose including power supply (Canopy + Power Supply) for continuous light bands and customised lighting configurations. On request: Integration of emergency lighting components, sensor technology.

C P4 A B E-8 30 M - M1200 - Y

- Product Family **C:** Cubic
- Type **G4:** Direct only, **P4:** Direct-Indirect
- Optical System **A:** Microprismatic, **O:** Opal Diffuser
- Surface Finish **W:** Snow White, **E:** Silver Anodised, **U:** Urban Graphite, **B:** Jet Black, **H:** Anodic Champagne
- Control Gear **E:** On/Off, **L:** DALI, **H:** Touch-Dim, **C:** Casambi, **6:** DALI DT6 for TW, **8:** DALI DT8 for TW
- Colour Rendering **8:** CRI>80, **9:** CRI>90, **F:** Full Spectrum [except 2200K]
- Colour Temperature **22:** 2200K, **27:** 2700K, **30:** 3000K, **35:** 3500K, **40:** 4000K, **65:** 6500K, **TW:** Tunable White 2700-6500K
- Power **M:** Medium Power, **H:** High Power
- Size Line Module: **M900, M1200, M1500**, Corner Module: **C600**
- Suspension **Y:** Y-Cord Suspension, **K:** Parallel Suspension
- On Request Multisensor

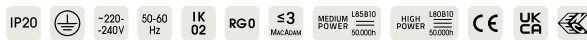

Microprismatic | Direct-Indirect

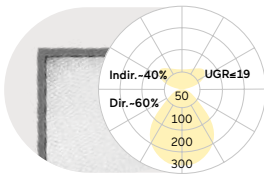

C mm	Lumen/Watt Medium Power	Lumen/Watt High Power
600x 600	4410lm/38W	5650lm/48W

Microprismatic | Direct

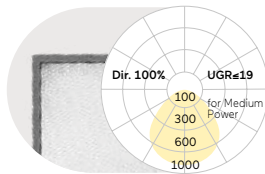

C mm	Lumen/Watt Medium Power	Lumen/Watt High Power
600x 600	2530lm/25W	3150lm/31W

Opal Diffuser | Direct-Indirect

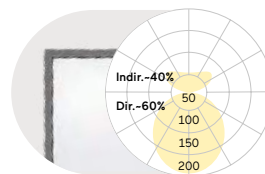

C mm	Lumen/Watt Medium Power	Lumen/Watt High Power
600x 600	4250lm/38W	5450lm/48W

Opal Diffuser | Direct

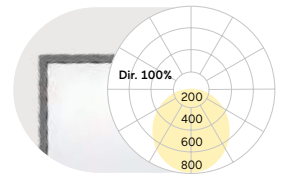

C mm	Lumen/Watt Medium Power	Lumen/Watt High Power
600x 600	2370lm/25W	2950lm/31W

See page 285 for parameters for the M900, M1200, and M1500 modules.
Lumen Values: Luminarie luminous flux at 4000K/CRI>80. Other configurations on request.

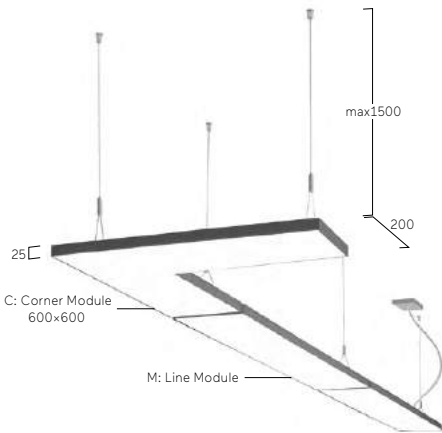

Surface Finish:

- W** Snow White
- E** Silver Anodised [Not available for Canopy]
- U** Urban Graphite
- B** Jet Black
- H** Anodic Champagne

Suspension Type:

- Y** Y-Cord Suspension
- K** Parallel Suspension

Cable Type:

- 5** 5x 0,75mm², Transparent cable

Code	Cable Length	Surface Finish	Cable Type
X Canopy	L1500	W	5



X Canopy + Power Supply Cable

Code	Connector Length	Connector Finish	Suspension Type
S Connector	L00	W	Y
S Connector	L20	W	Y
S Connector	L300	W	Y
S Connector	L500	W	Y

Code	Corner Length	Corner Finish	Suspension Type
C Corner	L170X170	W	Y



C Corner Connector with suspension



Multisensor



SL00 Edge to Edge Straight Connector with suspension

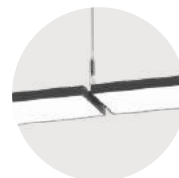

SL20 Straight Connector 20mm with suspension

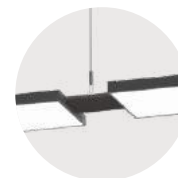

SL300 Straight Connector 300mm with suspension



SL500 Straight Connector 500mm with suspension

Cubic Evolution U4 | Suspended



DE LED-Pendelleuchte. Rein indirektstrahlend. Leuchtenkörper in minimalistischer Bauhöhe aus Aluminiumprofil. Oberfläche naturel oxidiert oder weiß, graphit, schwarz bzw. champagnerfarben lackiert. Weitere Oberflächenoptionen siehe Lightnet-Surface-Collection oder RAL nach Wahl. Konverter in Leuchtgehäuse integriert, wahlweise einfach schaltbar oder stufenlos dimmbar (DALI, Touch-Dim, Casambi). Farbtemperatur 2200K, 2700K, 3000K, 3500K, 4000K oder 6500K. Binning initial \leq MacAdam 3. Farbwiedergabe CRI>80, CRI>90 oder Full Spectrum. Stufenlos höhenverstellbare Parallel- oder Y-Seilabhängung mit transparent ummantelter Zuleitung oder Pendelrohrabhängung. Lackierung Baldachin passend Leuchtenkörper. Auf Anfrage: Integration von 48V-Stromschienen, 3-Phasen-Stromschienen oder Midpin-Spotlights für den direkten Lichtanteil.

EN LED pendant luminaire. Indirect only light distribution. Luminaire body with minimalistic overall height made of aluminium profile. Surface natural anodised or white, graphite, black or champagne coated. Further surface options see Lightnet-Surface-Collection or RAL of your choice. Driver integrated into luminaire housing, optionally switchable or dimmable (DALI, Touch-Dim, Casambi). Colour temperature 2200K, 2700K, 3000K, 3500K, 4000K or 6500K. Binning \leq MacAdam 3. Colour rendering CRI>80, CRI>90 or Full Spectrum. Height-adjustable parallel or Y-cord suspension with transparent power supply cable or rod suspension. Colour of ceiling rose matching luminaire body. On request: Integration of 48V tracks, 3-phase tracks or midpin spotlights for the direct light component.

C U4 U B E-8 30 M-L1200-K

- Product Family **C:** Cubic
- Type **U4:** Indirect only
- Optical System **U:** Indirect Optic
- Surface Finish **W:** Snow White, **E:** Silver Anodised, **U:** Urban Graphite, **B:** Jet Black, **H:** Anodic Champagne
- Control Gear **E:** On/Off, **L:** DALI, **H:** Touch-Dim
- Colour Rendering **8:** CRI>80, **9:** CRI>90, **F:** Full Spectrum [except 2200K]
- Colour Temperature **22:** 2200K, **27:** 2700K, **30:** 3000K, **35:** 3500K, **40:** 4000K, **65:** 6500K
- Power **M:** Medium Power, **H:** High Power
- Size Luminaire length in mm: **L900, L1200, L1500, L1800, L2100**
- Suspension **K:** Parallel Suspension, **Y:** Y-Cord Suspension
- On Request 3-Phase Track, Midpin/Midpoint Spotlights/Downlights



Indirect Optic | Indirect

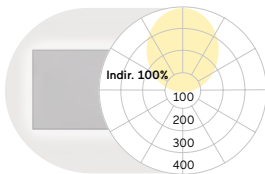

L mm	Lumen/Watt Medium Power	Lumen/Watt High Power
900	3800lm/28W	5160lm/39W
1200	5070lm/36W	6880lm/51W
1500	6340lm/45W	8600lm/63W
1800	7600lm/53W	10320lm/73W
2100	8870lm/61W	12040lm/85W

Lumen Values: Luminaire luminous flux at 4000K/CRI>80. Other configurations on request.

Parallel Suspension

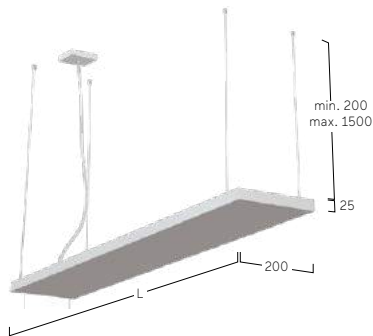

Y-Cord Suspension:



Midpin Downlight XD
310lm/5W/Ø21mm



Midpin Spotlight XM
770lm/10W/Ø40mm



3-Phase Track



W Snow White



E Silver Anodised



U Urban Graphite

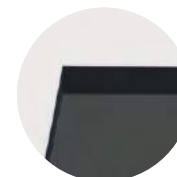

B Jet Black



H Anodic Champagne

Cubic Max G2/P2 | Suspended



DE LED-Pendelleuchte. Direkt-indirekt oder rein direktstrahlend. Leuchtenkörper mit Bauhöhe 75mm aus Aluminiumprofil. Oberfläche natureloxiert oder weiß, graphit, schwarz bzw. champagnerfarben lackiert. Weitere Oberflächenoptionen siehe Lightnet-Surface-Collection oder RAL nach Wahl. Microprismenoptik mit optimierter Blendungsbegrenzung speziell für Office-Anwendungen. Satiniertes Opaldiffusor (Q330-Q1200) und opale Folie (Q1500, Q2000) für Allgemeinbeleuchtung mit max. Transmissionsgrad und homogener Lichtpunktauflösung. Konverter in Leuchtengehäuse integriert, wahlweise einfach schaltbar oder stufenlos dimmbar (DALI, Touch-Dim, Casambi). Farbtemperatur 2200K, 2700K, 3000K, 3500K, 4000K, 6500K oder Tunable White (2700-6500K). Binning initial \leq MacAdam 3. Farbwiedergabe CRI $>$ 80, CRI $>$ 90 oder Full Spectrum. Stufenlos höhenverstellbare Seilabhängung mit transparent ummantelter Zuleitung. Lackierung Baldachin passend Leuchtenkörper. Auf Anfrage: Integration von Notlichtkomponenten, Sensortechnologie.

EN LED pendant luminaire. Direct-indirect or direct-only light distribution. Luminaire body made of 75mm high aluminium profile. Surface natural anodised or white, graphite, black or champagne coated. Further surface options see Lightnet-Surface-Collection or RAL of your choice. Micro-prismatic screen with optimized glare reduction especially for workplaces. Satin opal diffuser (Q330-Q1200) and opal foil (Q1500, Q2000) for general lighting with maximum transmittance and homogeneous lighting. Driver integrated into luminaire housing, optionally switchable or dimmable (DALI, Touch-Dim, Casambi). Colour temperature 2200K, 2700K, 3000K, 3500K, 4000K, 6500K or Tunable White (2700-6500K). Binning \leq MacAdam 3. Colour rendering CRI $>$ 80, CRI $>$ 90 or Full Spectrum. Height-adjustable cord suspension with transparent power supply cable. Colours ceiling rose match to luminaire body. On request: Integration of emergency lighting components, sensor technology.

C P2 A B E-8 30 M-Q630-K

Product Family **C:** Cubic

Type **G2:** Direct only, **P2:** Direct-Indirect

Optical System **A:** Microprismatic [Q330-Q1200], **O:** Opal Diffuser [Q330-Q1200], **T:** Opal Stretch Foil [Q1500, Q2000]

Surface Finish **W:** Snow White, **E:** Silver Anodised, **U:** Urban Graphite, **B:** Jet Black, **H:** Anodic Champagne

Control Gear **E:** On/Off, **L:** DALI, **H:** Touch-Dim, **C:** Casambi, **6:** DALI DT6 for TW, **8:** DALI DT8 for TW

Colour Rendering **8:** CRI>80, **9:** CRI>90, **F:** Full Spectrum [except 2200K]

Colour Temperature **22:** 2200K, **27:** 2700K, **30:** 3000K, **35:** 3500K, **40:** 4000K, **65:** 6500K, **TW:** Tunable White 2700-6500K [Q330-Q1200]

Power **M:** Medium Power, **H:** High Power

Size Square size in mm: **Q330, Q430, Q530, Q630, Q900, Q1200, Q1500, Q2000**

Suspension **K:** Parallel Suspension

On Request Emergency Module [Q430-Q1200], Multisensor [Q430-Q1200]



Microprismatic | Direct-Indirect

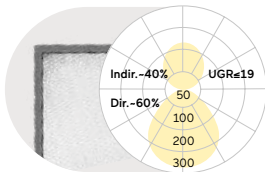

Q mm	Lumen/Watt Medium Power	Lumen/Watt High Power
330	2470lm/18W	3640lm/27W
430	4360lm/30W	6300lm/44W
530	6000lm/42W	11170lm/78W
630	9610lm/68W	14270lm/103W
900	11660lm/89W	18570lm/161W
1200	19310lm/152W	30990lm/273W

Microprismatic | Direct

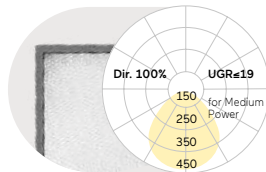

Q mm	Lumen/Watt Medium Power	Lumen/Watt High Power
330	1360lm/12W	2010lm/18W
430	2370lm/19W	3450lm/27W
530	3630lm/27W	6790lm/50W
630	5200lm/40W	8500lm/65W
900	7910lm/67W	13240lm/129W
1200	14100lm/122W	23550lm/228W

Opal Diffuser / Opal Stretch Foil | Direct-Indirect

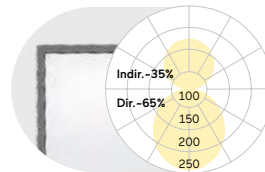

Q mm	Lumen/Watt Medium Power	Lumen/Watt High Power
330	2510lm/18W	3700lm/27W
430	4430lm/30W	6400lm/44W
530	6110lm/42W	11370lm/78W
630	9770lm/68W	14530lm/103W
900	11900lm/89W	18970lm/161W
1200	19730lm/152W	31700lm/273W
1500	30200lm/233W	47570lm/414W
2000	41580lm/318W	65800lm/578W

Opal Diffuser/ Opal Stretch Foil | Direct

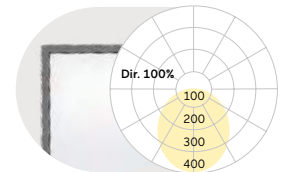

Q mm	Lumen/Watt Medium Power	Lumen/Watt High Power
330	1400lm/12W	2070lm/18W
430	2440lm/19W	3550lm/27W
530	3740lm/27W	6990lm/50W
630	5360lm/40W	8760lm/65W
900	8150lm/67W	13640lm/129W
1200	14520lm/122W	24260lm/228W
1500	21170lm/189W	34990lm/356W
2000	30490lm/268W	50380lm/510W

Lumen Values: Luminaire luminous flux at 4000K/CRI>80. Other configurations on request.

Parallel Suspension

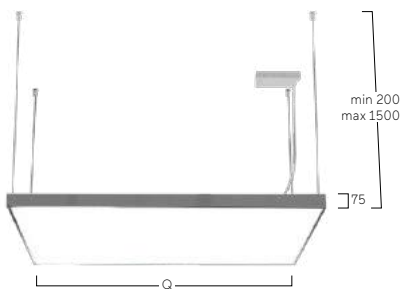

Multisensor



W Snow White



E Silver Anodised



U Urban Graphite



B Jet Black



H Anodic Champagne

Cubic Ambient G7/P7 | Suspended



DE LED-Pendelleuchte. Direkt-rundumstrahlend oder direkt-rundumstrahlend mit Indirektanteil. Leuchtenkörper aus Aluminium. Oberfläche weiß, silber, graphit, schwarz bzw. champagnerfarben lackiert. Weitere Oberflächenoptionen siehe Lightnet-Surface-Collection oder RAL nach Wahl. Ambientdiffusor aus satiniertem Acrylglas für Allgemeinbeleuchtung mit max. Transmissionsgrad und homogener Lichtpunktauflösung. Konverter in Leuchtgehäuse integriert, wahlweise einfach schaltbar oder stufenlos dimmbar (DALI, Touch-Dim, Casambi). Farbtemperatur 2200K, 2700K, 3000K, 3500K, 4000K oder 6500K. Binning initial \leq MacAdam 3. Farbwiedergabe CRI $>$ 80 oder CRI $>$ 90. Stufenlos höhenverstellbare Parallel-Seilabhangung mit transparent ummantelter Zuleitung. Lackierung Baldachin passend Leuchtenkorper. Auf Anfrage: Integration von Notlichtkomponenten.

EN LED pendant luminaire. Direct omnidirectional light distribution or direct omnidirectional light distribution with indirect lighting. Luminaire body made of aluminium. Surface white, silver, graphite, black or champagne coated. Further surface options see Lightnet-Surface-Collection or RAL of your choice. Ambient diffuser made of frosted acrylic glass for general lighting with maximum transmittance and homogeneous lighting. Driver integrated into luminaire housing, optionally switchable or dimmable (DALI, Touch-Dim, Casambi). Colour temperature 2200K, 2700K, 3000K, 3500K, 4000K or 6500K. Binning \leq MacAdam 3. Colour rendering CRI $>$ 80 or CRI $>$ 90. Height-adjustable parallel cord suspension with transparent power supply cable. Colours ceiling rose match to luminaire body. On request: Integration of emergency lighting components.

C P7 F B E-8 30 M-Q400-K

Product Family	C: Cubic
Type	G7: Direct only, P7: Direct-Indirect
Optical System	F: Ambient
Surface Finish	W: Snow White, S: Radiant Silver, U: Urban Graphite, B: Jet Black, H: Anodic Champagne
Control Gear	E: On/Off, L: DALI, H: Touch-Dim, C: Casambi
Colour Rendering	8: CRI>80, 9: CRI>90, F: Full Spectrum [except 2200K]
Colour Temperature	22: 2200K, 27: 2700K, 30: 3000K, 35: 3500K, 40: 4000K, 65: 6500K
Power	M: Medium Power, H: High Power
Size	Square size in mm: Q300, Q400, Q500, Q600
Suspension	K: Parallel Suspension
On Request	Emergency Module [Q400-Q600], Radar Sensor



Ambient Diffuser | Direct-Indirect

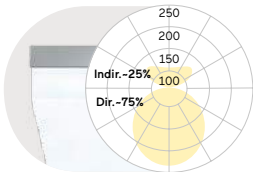

Ambient Diffuser | Direct

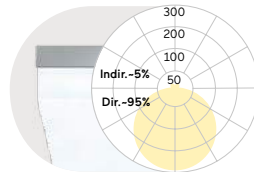

Q mm	Lumen/Watt Medium Power	Lumen/Watt High Power	Q mm	Lumen/Watt Medium Power	Lumen/Watt High Power
300	2110lm/17W	3050lm/23W	300	1480lm/12W	2150lm/15W
400	3950lm/28W	5190lm/36W	400	2950lm/21W	3880lm/27W
500	5840lm/41W	8480lm/59W	500	4410lm/30W	6520lm/43W
600	8400lm/58W	11290lm/78W	600	5650lm/38W	8540lm/58W

Lumen Values: Luminaire luminous flux at 4000K/CRI>80. Other configurations on request.

Parallel Suspension

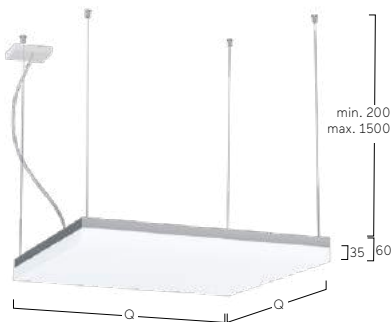

W Snow White



S Radiant Silver



U Urban Graphite



B Jet Black



H Anodic Champagne

Cubic Déco G3/P3 | Suspended



DE LED-Pendelleuchte. Direkt-indirekt oder rein direktstrahlend. Leuchtenkörper aus Aluminiumprofil. Gehäuse-Außenfläche und dekorativer Reflektoring in unterschiedlichen Lackierungen und Kombinationen erhältlich, z.B. weiß, silber, graphit, schwarz, gold oder kupferfarben. Zu Oberflächenoptionen- und Kombinationen siehe Lightnet-Surface-Collection oder Bi-Colour-Auswahl. Rückversetzte Microprismenoptik mit optimierter Blendungsbegrenzung speziell für Office-Anwendungen. Satinierter Opaldiffusor für Allgemeinbeleuchtung mit max. Transmissionsgrad und homogener Lichtpunktauflösung. Konverter in Leuchtgehäuse integriert, wahlweise einfach schaltbar oder stufenlos dimmbar (DALI, Touch-Dim, Casambi). Farbtemperatur 2200K, 2700K, 3000K, 3500K, 4000K, 6500K oder Tunable White (2700-6500K). Binning initial \leq MacAdam 3. Farbwiedergabe CRI $>$ 80, CRI $>$ 90 oder Full Spectrum. Stufenlos höhenverstellbare Parallel-Seilabhängung mit transparent ummantelter Zuleitung. Lackierung Baldachin passend Leuchtenkörper. Auf Anfrage: Integration von Notlichtkomponenten.

EN LED pendant luminaire. Direct-indirect or direct-only light distribution. Luminaire body made of aluminum profile. Outer housing and Decorative trim available in various finishes and combinations, e.g. white, silver, graphite, black, gold or copper coated. For surface options and combinations check Lightnet Surface Collection or RAL of your choice. Recessed microprismatic screen with optimized glare reduction especially for workplaces. Satin opal diffuser for general lighting with maximum transmittance and homogeneous lighting. Driver integrated into luminaire housing, optionally switchable or dimmable (DALI, Touch-Dim, Casambi). Colour temperature 2200K, 2700K, 3000K, 3500K, 4000K, 6500K or Tunable White (2700-6500K). Binning \leq MacAdam 3. Colour rendering CRI $>$ 80, CRI $>$ 90 or Full Spectrum. Height-adjustable parallel cord suspension with transparent power supply cable. Colours ceiling rose match to luminaire body. On request: Integration of emergency lighting components.

C P3 A WE-8 30 M-Q330-KG

- Product Family **C:** Cubic
- Type **G3:** Direct only, **P3:** Direct-Indirect
- Optical System **A:** Microprismatic, **O:** Opal Diffuser
- Surface Finish **W:** Snow White, **V:** Ivory White, **S:** Radiant Silver, **U:** Urban Graphite, **B:** Jet Black, **H:** Anodic Champagne, **K:** Satin Copper
- Control Gear **E:** On/Off, **L:** DALI, **H:** Touch-Dim, **C:** Casambi, **6:** DALI DT6 for TW, **8:** DALI DT8 for TW
- Colour Rendering **8:** CRI>80, **9:** CRI>90, **F:** Full Spectrum [except 2200K]
- Colour Temperature **22:** 2200K, **27:** 2700K, **30:** 3000K, **35:** 3500K, **40:** 4000K, **65:** 6500K, **TW:** Tunable White 2700-6500K [Q330-Q1200]
- Power **M:** Medium Power, **H:** High Power
- Size Square Size in mm: **Q330, Q430, Q530, Q630, Q900, Q1200**
- Suspension **K:** Parallel Suspension
- Reflector **W:** Snow White, **V:** Ivory White, **S:** Radiant Silver, **U:** Urban Graphite, **B:** Jet Black, **H:** Anodic Champagne, **K:** Satin Copper, **G:** Satin Gold
- On Request Radar Sensor, Emergency Module [Q430-Q1200]



Microprismatic | Direct-Indirect

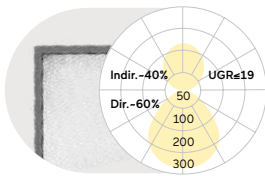

Microprismatic | Direct

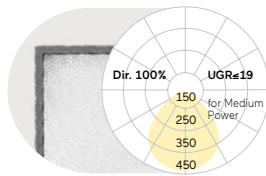

Opal Diffuser | Direct-Indirect

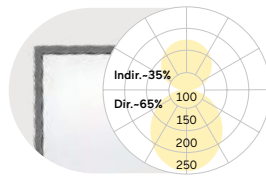

Opal Diffuser | Direct

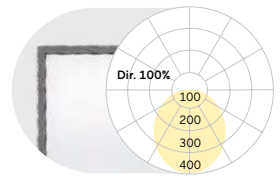

Q mm	Lumen/Watt Medium Power	Lumen/Watt High Power
330	2470lm/18W	3640lm/27W
430	4360lm/30W	6300lm/44W
530	6000lm/42W	11170lm/78W
630	9610lm/68W	14270lm/103W
900	11660lm/89W	18570lm/161W
1200	19310lm/152W	30990lm/273W

Q mm	Lumen/Watt Medium Power	Lumen/Watt High Power
330	1360lm/12W	2010lm/18W
430	2370lm/19W	3450lm/27W
530	3630lm/27W	6790lm/50W
630	5200lm/40W	8500lm/65W
900	7910lm/67W	13240lm/129W
1200	14100lm/122W	23550lm/228W

Q mm	Lumen/Watt Medium Power	Lumen/Watt High Power
330	2510lm/18W	3700lm/27W
430	4430lm/30W	6400lm/44W
530	6110lm/42W	11370lm/78W
630	9770lm/68W	14530lm/103W
900	11900lm/89W	18970lm/161W
1200	19730lm/152W	31700lm/273W

Q mm	Lumen/Watt Medium Power	Lumen/Watt High Power
330	1400lm/12W	2070lm/18W
430	2440lm/19W	3550lm/27W
530	3740lm/27W	6990lm/50W
630	5360lm/40W	8760lm/65W
900	8150lm/67W	13640lm/129W
1200	14520lm/122W	24260lm/228W

Lumen Values: Luminaire luminous flux at 4000K/CRI>80. Other configurations on request.

Parallel Suspension

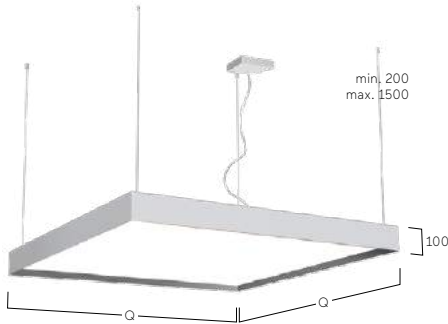

W Snow White
W Snow White



W Snow White
S Radiant Silver



W Snow White
B Jet Black



W Snow White
G Satin Gold



W Snow White
H Anodic Champagne



W Snow White
K Satin Copper

Matric Déco G9/R9 | Suspended



DE LED-Pendelleuchte. Direkt-indirekt oder rein direktstrahlend. Lichtkanal aus Aluminiumprofil mit 55mm Profilbreite. Millimetergenaue Längenfertigung nach Vorgabe möglich. Rückversetzte Optik für bessere Blendungsbegrenzung und dekorative Lichtwirkung. Gehäuse-Außenfläche und rundum laufender Reflektorring in unterschiedlichen Lackierungen und Kombinationen erhältlich. Oberflächenoptionen siehe Lightnet-Surface-Collection oder RAL nach Wahl. Direktanteil über Präzisionslinsen mit Abblendraaster für breite rotationssymmetrische Lichtstärkeverteilung bei gleichzeitig hoher Blendungsbegrenzung (UGR<19) für Office Anwendungen. Abblendraaster in verschiedenen Farbkombinationen erhältlich. Microprismenoptik aus Spezialacrylglas mit optimierter Blendungsbegrenzung für Office-Anwendungen. Satiniertes Opaldiffusor für Allgemeinbeleuchtung mit max. Transmissionsgrad und homogener Lichtpunktauflösung. Konverter in Leuchtengehäuse integriert, wahlweise einfach schaltbar oder stufenlos dimmbar (DALI, Touch-Dim, Casambi). Farbtemperatur 2200K, 2700K, 3000K, 3500K, 4000K, 6500K oder Tunable White (2700-6500K). Binning initial \leq MacAdam 3. Farbwiedergabe CRI>80, CRI>90 oder Full Spectrum. Stufenlos höhenverstellbare Y-Seilabhängung mit transparent ummantelter Zuleitung. Lackierung Baldachin passend Leuchtenkörper. Auf Anfrage: Integration von Stromschienen.

EN LED pendant luminaire. Direct-indirect or direct-only light distribution. Light channel made of aluminium profile with 55mm profile width. Bespoke lengths possible. Recessed screen with optimized glare reduction and decorative lighting impact. Outer housing and all-around reflector ring available in various finishes and combinations. Further surface options see Lightnet-Surface-Collection or RAL of your choice. Direct light using precision lenses with louvre for wide uniform symmetrical light distribution with high glare limitation (UGR<19) especially for workplaces. Louvre available in various colour finishes. Microprismatic screen made of special acrylic glass with optimized glare reduction especially for workplaces. Satin opal diffuser for general lighting with maximum transmittance and homogeneous lighting. Driver integrated into luminaire housing, optionally switchable or dimmable (DALI, Touch-Dim, Casambi). Colour temperature 2200K, 2700K, 3000K, 3500K, 4000K, 6500K or Tunable White (2700-6500K). Binning \leq MacAdam 3. Colour rendering CRI>80, CRI>90 or Full Spectrum. Height-adjustable Y-cord suspension with transparent power supply cable. Colours ceiling rose match to luminaire body. On request: Integration of tracks.

L G9 L W E - 8 3 0 M - L 1 2 0 9 - Y B *

- Product Family **L:** Matric
- Type **G9:** Direct only, **R9:** Direct-indirect
- Optical System **A:** Microprismatic, **O:** Opal Diffuser, **L:** Lens Louvre*
- Surface Finish **W:** Snow White, **V:** Ivory White, **A:** Satin Silver, **E:** Silver Anodised,
U: Urban Graphite, **B:** Jet Black, **H:** Anodic Champagne, **K:** Satin Copper
- Control Gear **E:** On/Off, **L:** DALI, **H:** Touch-Dim, **C:** Casambi, **6:** DALI DT6 for TW [L1182-L2055], **8:** DALI DT8 for TW
- Colour Rendering **8:** CRI>80, **9:** CRI>90, **F:** Full Spectrum [except 2200K]
- Colour Temperature **22:** 2200K, **27:** 2700K, **30:** 3000K, **35:** 3500K, **40:** 4000K, **65:** 6500K, **TW:** Tunable White 2700-6500K
- Power **E:** Low Power, **M:** Medium Power, **H:** High Power
- Size Luminaire Length in mm (Microprismatic, Opal Diffuser): **L890, L1182, L1475, L1765, L2055**
Luminaire Length in mm (Lens Louvre*): **L945, L1209, L1474, L1738, L2002**
- Suspension **Y:** Y-Cord Suspension
- Reflector colour **W:** Snow White, **V:** Ivory White, **A:** Satin Silver, **U:** Urban Graphite, **B:** Jet Black, **H:** Anodic Champagne, **K:** Satin Copper, **G:** Satin Gold
- On Request Emergency Module [L1182-L2055]

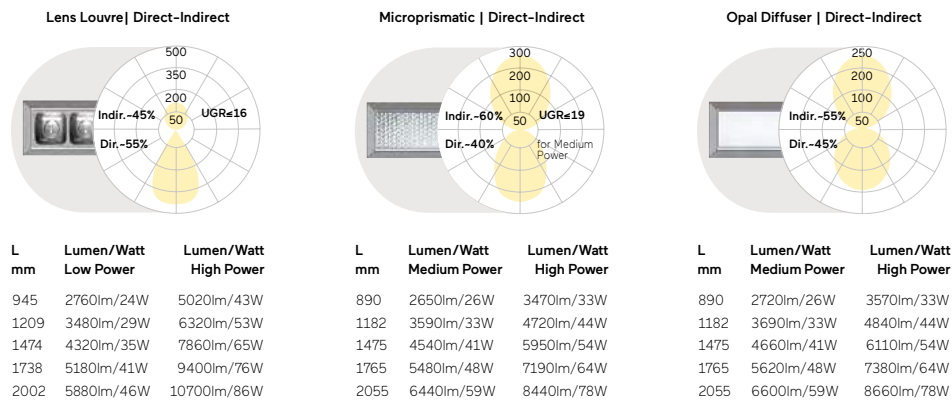
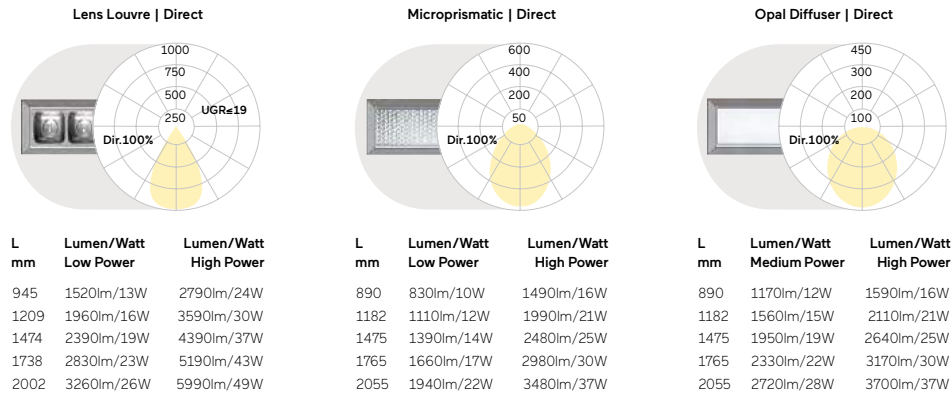

Lumen Values: Luminarie luminous flux at 4000K/CRI>80. Other configurations on request.

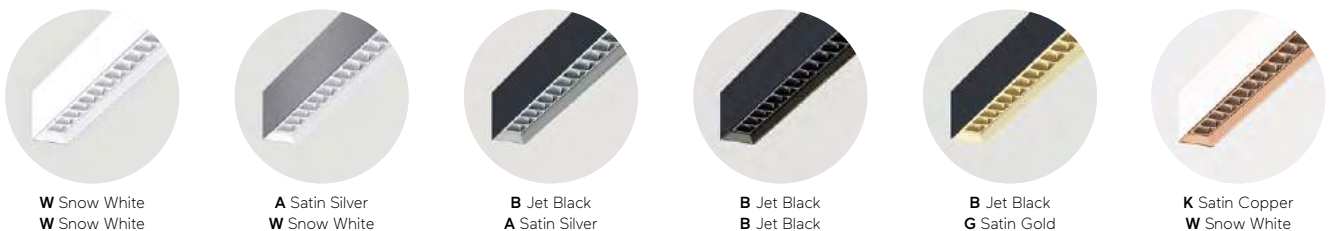
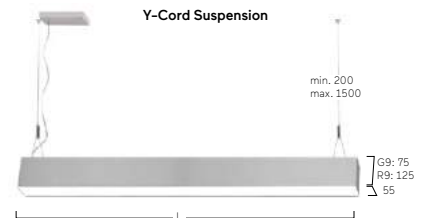

Matric Suspended

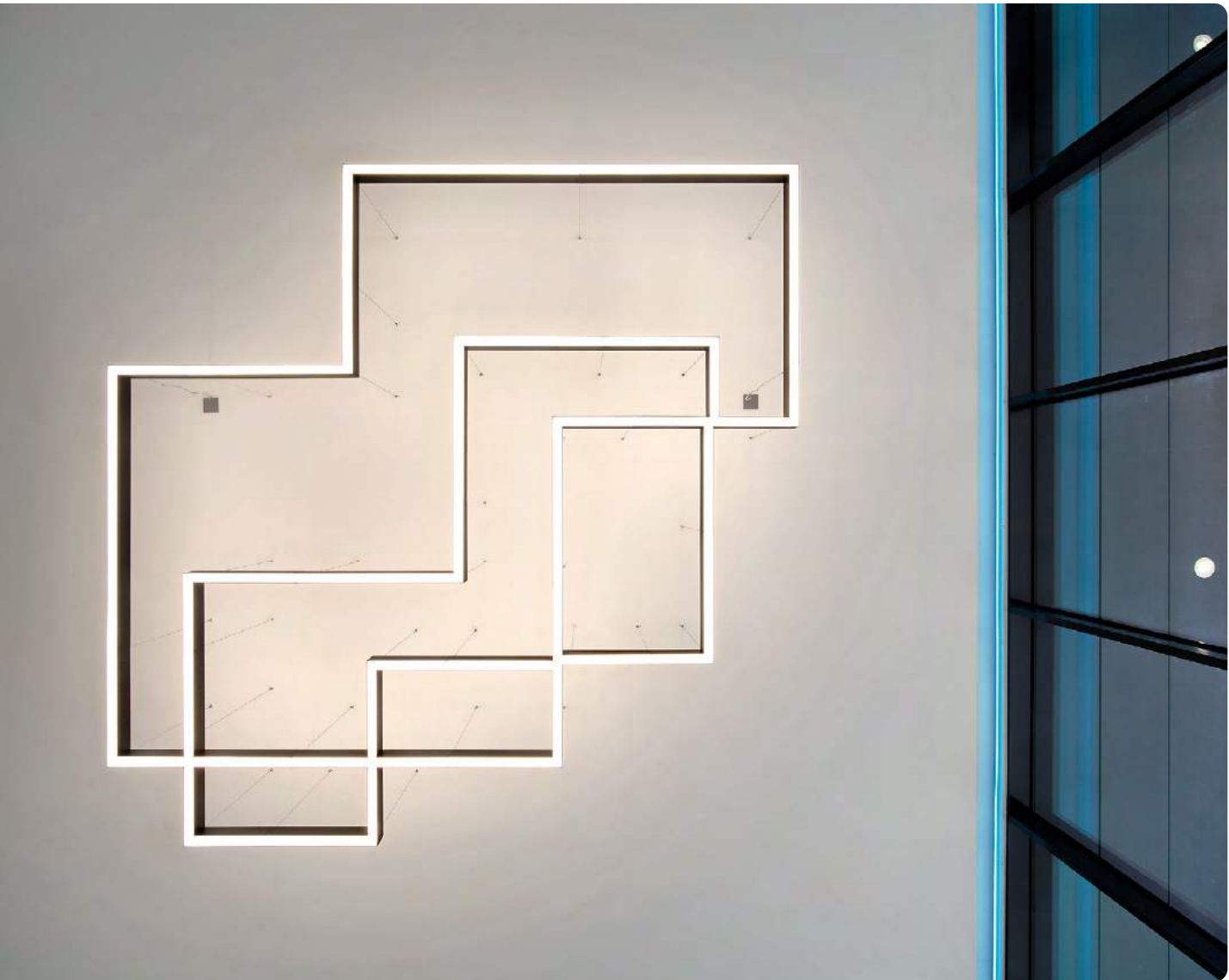

Halo Innovation Hub, Kilmarnock, UK
Matric-R4



Matric Suspended



The Stars Group, Hyderabad, India
Matric R3

Adobe Head Office, Sydney, Australia
Matric R3





Life Science Office, Dublin, Ireland
 Matric G3
 Photography: Donal Murphy Photography
 Planning: dlight

Westeria, Ostbevern, Germany
 Matric R1 with Midpoint 3-Phase Track C6
 Realization and photography: Scharkon
 Lichtkonzepte GmbH/Oliver Kahl Photography



Matric Suspended



Schweickert, Nußloch, Germany
Matric R1
Planning: Architect Scope

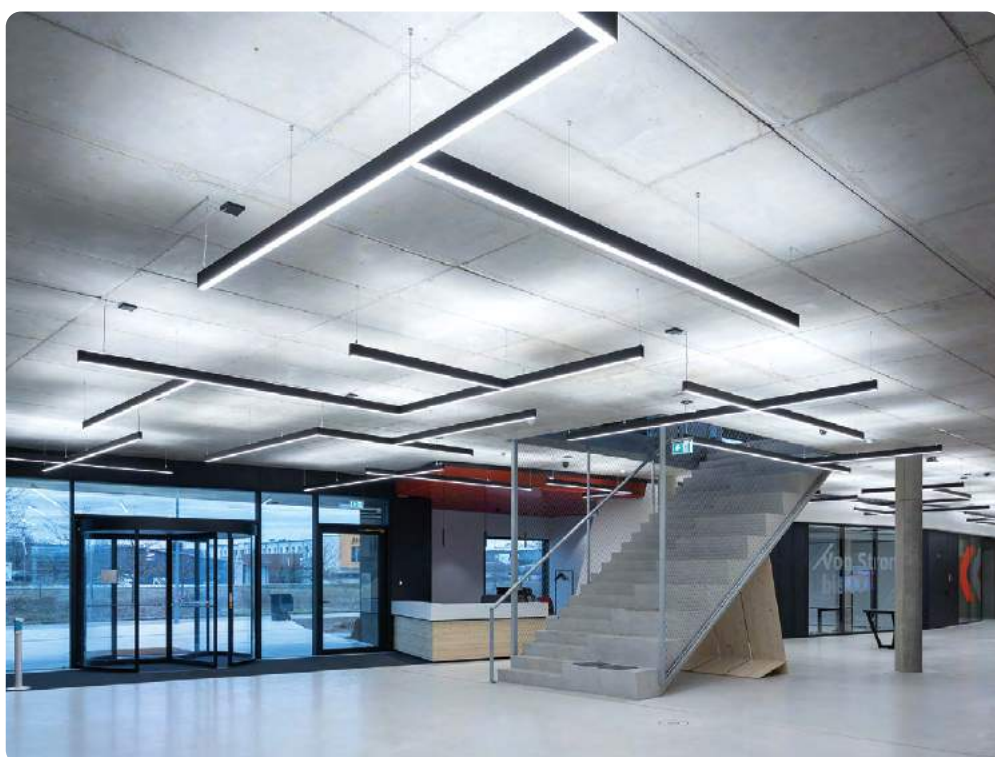



Matric RY | System 40mm Suspended

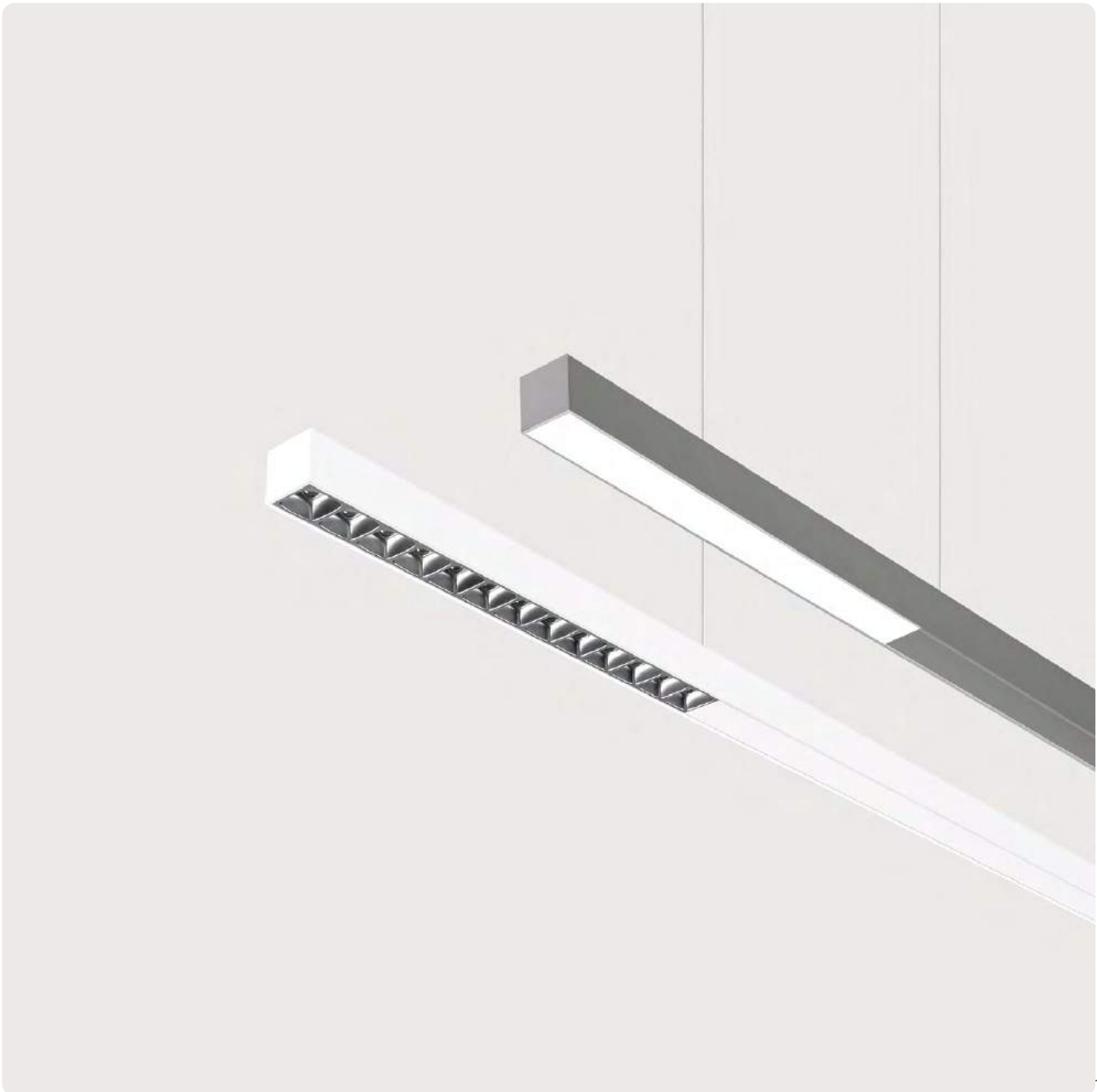

DE LED-Pendelleuchte. Direkt-indirektstrahlend (indirektes Licht über die gesamte Leuchtenlänge). Leuchtenkörper aus Aluminiumprofil mit 40x40mm Querschnitt. Millimetergenaue Längenfertigung nach Vorgabe möglich. Oberfläche natureloxiiert oder weiß, graphit, schwarz, champagner oder kupferfarben lackiert. Weitere Oberflächenoptionen siehe Lightnet-Surface-Collection oder RAL nach Wahl. Direktanteil über Präzisionslinsen mit Abblenderaster für breite rotationssymmetrische Lichtstärkeverteilung bei gleichzeitig hoher Blendungsbegrenzung ($UGR < 19$) für Office Anwendungen. Abblenderaster in verschiedenen Farbkombinationen erhältlich. Alternativ Microprismenoptik aus Spezialacrylglas mit optimierter Blendungsbegrenzung für Office-Anwendungen. Konverter hinter Blindfeldern in Leuchtgehäuse integriert, wahlweise einfach schaltbar oder stufenlos dimmbar (DALI, Touch-Dim, Casambi). Farbtemperatur 2700K, 3000K, 3500K, 4000K, 6500K. Binning initial \leq MacAdam 3. Farbwiedergabe $CRI > 80$, $CRI > 90$ oder Full Spectrum. Stufenlos höhenverstellbare Seilabhängung mit transparent ummantelter Zuleitung. Lackierung Baldachin passend Leuchtenkörper. Auf Anfrage: Integration von Notlichtkomponenten, Sensortechnologie.

EN LED pendant luminaire. Direct-indirect light distribution (Indirect light across the entire length of the luminaire). Luminaire body made of aluminium profile with 40x40mm cross-section. Bespoke lengths are possible. Surface natural anodised or white, graphite, black, champagne or copper coated. Further surface options see Lightnet-Surface-Collection or RAL of your choice. Direct light using precision lenses with louvre for wide uniform symmetrical light distribution with high glare limitation ($UGR < 19$) especially for workplaces. Louvre available in various colour finishes. Alternatively, microprismatic screen made of special acrylic glass with optimized glare reduction especially for workplaces. Driver integrated into luminaire housing behind blind bays, optionally switchable or dimmable (DALI, Touch-Dim, Casambi). Colour temperature 2700K, 3000K, 3500K, 4000K or 6500K. Binning \leq MacAdam 3. Colour rendering $CRI > 80$, $CRI > 90$ or Full Spectrum. Height-adjustable cord suspension with transparent power supply cable. Colours ceiling rose match to luminaire body. On request: Integration of emergency lighting components, sensor technology.

L R Y L W E - 8 3 0 M - L1750-AB*

Product Family **L:** Matric

Type **RY:** Direct-indirect

Optical System **A:** Microprismatic, **O:** Opal Diffuser, **L:** Lens Louvre*

Surface Finish **W:** Snow White, **V:** Ivory White, **A:** Satin Silver, **S:** Radiant Silver
U: Urban Graphite, **B:** Jet Black, **H:** Anodic Champagne, **K:** Satin Copper

Control Gear **E:** On/Off, **L:** DALI, **H:** Touch-Dim, **C:** Casambi [+100 mm]

Colour Rendering **8:** CRI>80, **9:** CRI>90, **F:** Full Spectrum [except 2200K]

Colour Temperature **22:** 2200K, **27:** 2700K, **30:** 3000K, **35:** 3500K, **40:** 4000K, **65:** 6500K

Power **M:** Medium Power, **H:** High Power

Size Luminaire Length in mm: **L1750, L2400, L2930**

Suspension **A:** Single Cord Suspension

Lens Louvre* **W:** Snow White, **A:** Satin Silver, **B:** Jet Black, **H:** Anodic Champagne, **K:** Satin Copper, **G:** Satin Gold

On Request Multisensor [+200 mm]



Lens Louvre | Direct-Indirect

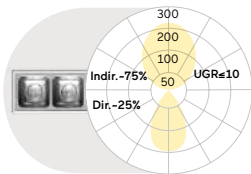

Microprismatic | Direct-Indirect

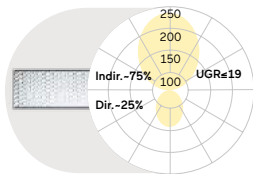

Opal Diffuser | Direct-Indirect

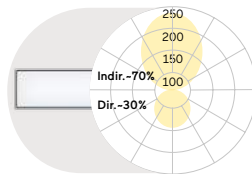

L mm	Lumen/Watt	
	Medium Power	High Power
1750	6880lm/53W	7480lm/58W
2400	9140lm/68W	9880lm/74W
2930	11800lm/85W	12850lm/94W

L mm	Lumen/Watt	
	Medium Power	High Power
1750	6960lm/55W	7600lm/62W
2400	9160lm/70W	9920lm/78W
2930	12030lm/91W	13170lm/104W

L mm	Lumen/Watt	
	Medium Power	High Power
1750	7080lm/55W	7760lm/62W
2400	9300lm/70W	10110lm/78W
2930	12240lm/91W	13460lm/104W

Lumen Values: Luminaire luminous flux at 4000K/CRI>80. Other configurations on request.

Single Cord Suspension

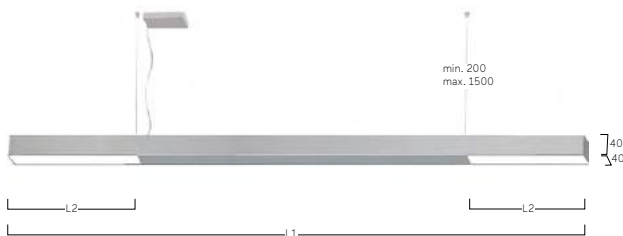

L1	L2 Lens Louvre	L2 Microprismatic, Opal Diffuser
1750	529	490
2400	661	590
2930	925	881



Multisensor



W Snow White
A Satin Silver



S Radiant Silver
A Satin Silver



W Snow White
B Jet Black



B Jet Black
H Anodic Champagne



B Jet Black
G Satin Gold



V Ivory White
H Anodic Champagne

Matric GX/RX | System 40mm Suspended

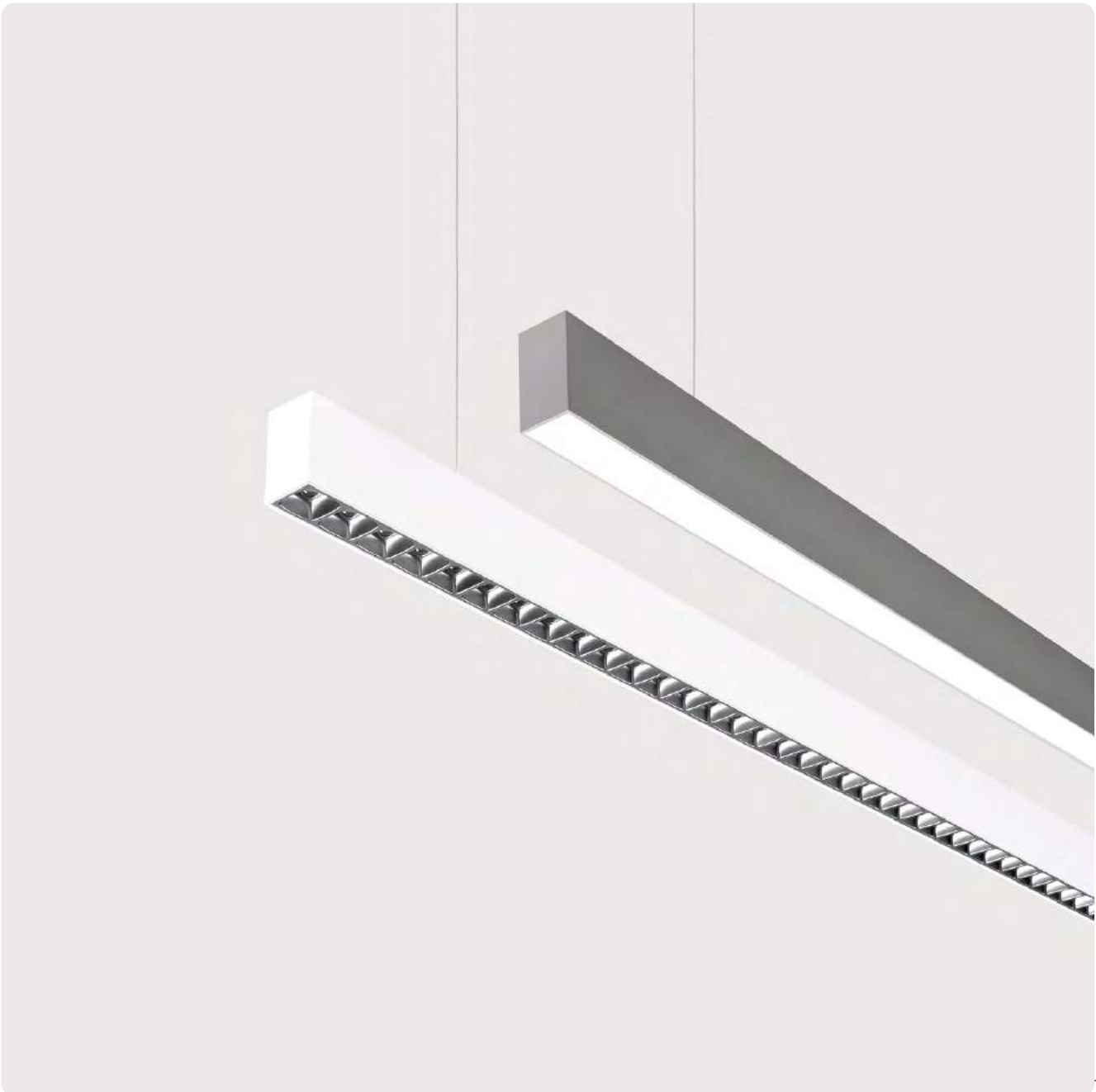

DE LED-Pendelleuchte. Direkt-indirekt oder rein direktstrahlend. Lichtkanal aus Aluminiumprofil mit 40mm Profildbreite. Millimetergenaue Längenfertigung nach Vorgabe möglich. Oberfläche natureloxiert oder weiß, graphit, schwarz, champagner oder kupferfarben lackiert. Weitere Oberflächenoptionen siehe Lightnet-Surface-Collection oder RAL nach Wahl. Direktanteil über Präzisionslinsen mit Abblendraster für breite rotationssymmetrische Lichtstärkeverteilung bei gleichzeitig hoher Blendungsbegrenzung ($UGR < 19$) für Office Anwendungen. Abblendraster in verschiedenen Farbkombinationen erhältlich. Microprismenoptik aus Spezialacrylglas mit optimierter Blendungsbegrenzung für Office-Anwendungen. Satiniertes Opaldiffusor für Allgemeinbeleuchtung mit max. Transmissionsgrad und homogener Lichtpunktauflösung. Wallwasher für homogene Beleuchtung vertikaler Flächen. Indirektanteil mit innovativer Linsentechnologie für breitstrahlende Deckenaufhellung. Konverter in Leuchtengehäuse integriert, wahlweise einfach schaltbar oder stufenlos dimmbar (DALI, Touch-Dim, Casambi). Farbtemperatur 2200K, 2700K, 3000K, 3500K, 4000K, 6500K oder Tunable White (2700-6500K). Binning initial \leq MacAdam 3. Farbwiedergabe $CRI > 80$, $CRI > 90$ oder Full Spectrum. Stufenlos höhenverstellbare Seilabhängung mit transparent ummantelter Zuleitung. Lackierung Baldachin passend Leuchtenkörper. Auf Anfrage: Integration von Stromschienen und Strahlern, Notlichtkomponenten, Sensortechnologie.

EN LED pendant luminaire. Direct-indirect or direct-only light distribution. Light channel made of 40mm wide aluminium profile. Bespoke lengths are possible. Surface natural anodised or white, graphite, black, champagne or copper coated. Further surface options see Lightnet-Surface-Collection or RAL of your choice. Direct light using precision lenses with louvre for wide uniform symmetrical light distribution with high glare limitation ($UGR < 19$) especially for workplaces. Louvre available in various colour finishes. Microprismatic screen made of special acrylic glass with optimized glare reduction especially for workplaces. Satin opal diffuser for general lighting with maximum transmittance and homogeneous lighting. Wallwasher for homogeneous illumination of vertical surfaces. Indirect light with innovative lens technology for wide-angle ceiling illumination. Driver integrated into luminaire housing, optionally switchable or dimmable (DALI, Touch-Dim, Casambi). Colour temperature 2200K, 2700K, 3000K, 3500K, 4000K, 6500K or Tunable White (2700-6500K). Binning \leq MacAdam 3. Colour rendering $CRI > 80$, $CRI > 90$ or Full Spectrum. Height-adjustable cord suspension with transparent power supply cable. Colours ceiling rose match to luminaire body. On request: Integration of tracks and spotlights, emergency lighting components, sensor technology.

L GXLWE - 830 E - L1194-AB*

Product Family	L: Matric
Type	GX: Direct only, RX: Direct-indirect
Optical System	A: Microprismatic, O: Opal Diffuser, G: Wallwasher, L: Lens Louvre*
Surface Finish	W: Snow White, V: Ivory White, A: Satin Silver, E: Silver Anodised, U: Urban Graphite, B: Jet Black, H: Anodic Champagne, K: Satin Copper
Control Gear	E: On/Off, L: DALI, H: Touch-Dim, C: Casambi, 6: DALI DT6 for TW [L1475-L2055], 8: DALI DT8 for TW
Colour Rendering	8: CRI>80, 9: CRI>90, F: Full Spectrum [except 2200K]
Colour Temperature	22: 2200K, 27: 2700K, 30: 3000K, 35: 3500K, 40: 4000K, 65: 6500K, TW: Tunable White 2700-6500K
Power	E: Low Power, M: Medium Power, H: High Power
Size	Luminaire Length in mm (Microprismatic, Opal Diffuser, Wallwasher): L890, L1182, L1475, L1765, L2055 Luminaire Length in mm (Lens Louvre*): L930, L1194, L1458, L1723, L1987
Suspension	A: Single Cord Suspension
Lens Louvre*	W: Snow White, A: Satin Silver, B: Jet Black, H: Anodic Champagne, K: Satin Copper, G: Satin Gold
On Request	90°Corner, Midpin Spotlights XM, Midpin Spotlights XP, Multisensor [L1182-L2055], Emergency Module [L1182-L2055]



Lens Louvre Direct-Indirect			Microprismatic Direct-Indirect			Opal Diffuser Direct-Indirect			Wallwasher Direct-Indirect		
L	Lumen/Watt	Lumen/Watt	L	Lumen/Watt	Lumen/Watt	L	Lumen/Watt	Lumen/Watt	L	Lumen/Watt	Lumen/Watt
mm	Low Power	High Power	mm	Medium Power	High Power	mm	Medium Power	High Power	mm	Medium Power	High Power
930	2760lm/24W	5020lm/43W	890	2760lm/26W	3630lm/33W	890	2850lm/26W	3740lm/33W	890	2810lm/26W	3590lm/34W
1194	3480lm/29W	6320lm/53W	1182	3750lm/33W	4930lm/44W	1182	3860lm/33W	5080lm/44W	1182	3810lm/37W	4880lm/48W
1458	4320lm/35W	7860lm/65W	1475	4730lm/41W	6220lm/54W	1475	4870lm/41W	6410lm/54W	1475	4810lm/45W	6150lm/59W
1723	5180lm/41W	9400lm/76W	1765	5720lm/48W	7510lm/64W	1765	5890lm/48W	7740lm/64W	1765	5810lm/54W	7430lm/70W
1987	5880lm/46W	10700lm/86W	2055	6710lm/59W	8810lm/78W	2055	6910lm/59W	9070lm/78W	2055	6820lm/65W	8720lm/85W

Lens Louvre Direct			Microprismatic Direct			Opal Diffuser Direct			Wallwasher Direct		
L	Lumen/Watt	Lumen/Watt	L	Lumen/Watt	Lumen/Watt	L	Lumen/Watt	Lumen/Watt	L	Lumen/Watt	Lumen/Watt
mm	Low Power	High Power	mm	Low Power	High Power	mm	Medium Power	High Power	mm	Medium Power	High Power
930	1520lm/13W	2790lm/24W	890	920lm/10W	1650lm/16W	890	1300lm/12W	1760lm/16W	890	1260lm/15W	1610lm/19W
1194	1960lm/16W	3590lm/30W	1182	1230lm/12W	2200lm/21W	1182	1730lm/15W	2350lm/21W	1182	1680lm/19W	2150lm/25W
1458	2390lm/19W	4390lm/37W	1475	1530lm/14W	2750lm/25W	1475	2160lm/19W	2940lm/25W	1475	2100lm/23W	2680lm/30W
1723	2830lm/23W	5190lm/43W	1765	1840lm/17W	3300lm/30W	1765	2600lm/22W	3530lm/30W	1765	2520lm/28W	3220lm/36W
1987	3260lm/26W	5990lm/49W	2055	2150lm/22W	3850lm/37W	2055	3030lm/28W	4110lm/37W	2055	2940lm/34W	3760lm/44W

Lumen Values: Luminaire luminous flux at 4000K/CRI>80. Other configurations on request.

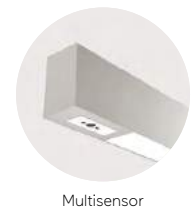
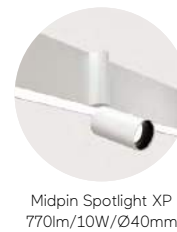
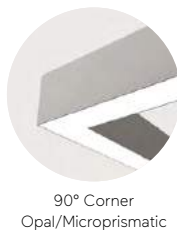

Matric G3/R3 | System 55mm Suspended



DE LED-Pendelleuchte. Direkt-indirekt oder rein direktstrahlend. Lichtkanal aus Aluminiumprofil mit 55mm Profildbreite. Millimetergenaue Längenfertigung nach Vorgabe möglich. Oberfläche natureloxiert oder weiß, graphit, schwarz, champagner oder kupferfarben lackiert. Weitere Oberflächenoptionen siehe Lightnet-Surface-Collection oder RAL nach Wahl. Direktanteil über Präzisionslinsen mit Abblendraaster für breite rotationssymmetrische Lichtstärkeverteilung bei gleichzeitig hoher Blendungsbegrenzung (UGR<19). Abblendraaster in verschiedenen Farbkombinationen erhältlich. Microprismenoptik aus Spezialacrylglas mit optimierter Blendungsbegrenzung für Office-Anwendungen. Satinierter Opaldiffusor für Allgemeinbeleuchtung mit max. Transmissionsgrad und homogener Lichtpunktauflösung. Wallwasher für homogene Beleuchtung vertikaler Flächen. Konverter in Leuchtengehäuse integriert, wahlweise einfach schaltbar oder stufenlos dimmbar (DALI, Touch-Dim, Casambi). Farbtemperatur 2200K, 2700K, 3000K, 3500K, 4000K, 6500K oder Tunable White (2700-6500K). Binning initial \leq MacAdam 3. Farbwiedergabe CRI>80, CRI>90 oder Full Spectrum. Stufenlos höhenverstellbare Y-Seilabhängung mit transparent ummantelter Zuleitung. Lackierung Baldachin passend Leuchtenkörper. Auf Anfrage: Integration von Stromschienen und Strahlern, Notlichtkomponenten, Sensortechnologie.

EN LED pendant luminaire. Direct-indirect or direct-only light distribution. Light channel made of 55mm wide aluminium profile. Bespoke lengths are possible. Surface natural anodised or white, graphite, black, champagne or copper coated. Further surface options see Lightnet-Surface-Collection or RAL of your choice. Direct light using precision lenses with louvre for wide uniform symmetrical light distribution with high glare limitation (UGR<19). Louvre available in various colour finishes. Microprismatic screen made of special acrylic glass with optimized glare reduction especially for workplaces. Satin opal diffuser for general lighting with maximum transmittance and homogeneous lighting. Wallwasher for homogeneous illumination of vertical surfaces. Driver integrated into luminaire housing, optionally switchable or dimmable (DALI, Touch-Dim, Casambi). Colour temperature 2200K, 2700K, 3000K, 3500K, 4000K, 6500K or Tunable White (2700-6500K). Binnings \leq MacAdam 3. Colour rendering CRI>80, CRI>90 or Full Spectrum. Height-adjustable Y-cord suspension with transparent power supply cable. Colours ceiling rose match to luminaire body. On request: Integration of tracks and spotlights, emergency lighting components, sensor technology.

L R3 L B E-8 30 M-L1002-YB*

Product Family	L: Matric
Type	G3: Direct only, R3: Direct-Indirect
Optical System	A: Microprismatic, O: Opal Diffuser, G: Wallwasher, L: Lens Louvre*, D: Opal Diffuser (Polycarbonate)**
Surface Finish	W: Snow White, E: Silver Anodised, U: Urban Graphite, B: Jet Black, H: Anodic Champagne, K: Satin Copper
Control Gear	E: On/Off, L: DALI, H: Touch-Dim, C: Casambi, 6: DALI DT6 for TW [L1475-L2055], 8: DALI DT8 for TW
Colour Rendering	8: CRI>80, 9: CRI>90, F: Full Spectrum [except 2200K]
Colour Temperature	22: 2200K, 27: 2700K, 30: 3000K, 35: 3500K, 40: 4000K, 65: 6500K, TW: Tunable White 2700-6500K
Power	E: Low Power, M: Medium Power, H: High Power
Size	Luminaire Length in mm (Microprismatic, Opal Diffuser, Wallwasher): L890, L1182, L1475, L1765, L2055 Luminaire Length in mm (Lens Louvre*): L1002, L1252, L1502, L1752, L2002
Suspension	Y: Y-Cord Suspension
Lens Louvre*	W: Snow White, A: Satin Silver, B: Jet Black, H: Anodic Champagne, K: Satin Copper, G: Satin Gold
On Request	90°Corner, Midpin Spotlights XM, Midpin Spotlights XP, Multisensor [L1182-L2055], Emergency Module [L1182-L2055]

**Opal Diffuser made of sustainable TruCircle Polycarbonate / Fire Rated

- Glow wire flammability Index 950°C EN60695-2-12 / Tp(a). Luminous flux reduction of 10%



Lens Louvre | Direct-Indirect

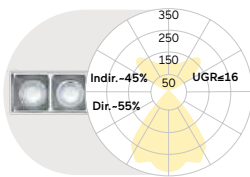

L mm	Lumen/Watt Medium Power	Lumen/Watt High Power
1002	4510lm/34W	6340lm/48W
1252	5800lm/42W	8170lm/61W
1502	6870lm/49W	9660lm/71W
1752	8160lm/57W	11470lm/83W
2002	9240lm/63W	12990lm/96W

Microprismatic | Direct-Indirect

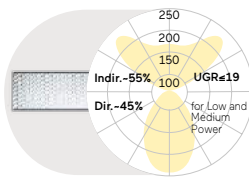

L mm	Lumen/Watt Low Power	Lumen/Watt Medium Power	Lumen/Watt High Power
890	2500lm/22W	3440lm/30W	4790lm/42W
1182	3390lm/28W	4660lm/39W	6490lm/55W
1475	4270lm/35W	5890lm/48W	8200lm/68W
1765	5150lm/41W	7110lm/56W	9890lm/81W
2055	6040lm/50W	8330lm/69W	11600lm/98W

Opal Diffuser | Direct-Indirect

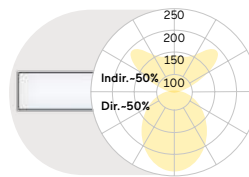

L mm	Lumen/Watt Low Power	Lumen/Watt Medium Power	Lumen/Watt High Power
890	2620lm/22W	3600lm/30W	5020lm/42W
1182	3540lm/28W	4880lm/39W	6800lm/55W
1475	4460lm/35W	6150lm/48W	8580lm/68W
1765	5390lm/41W	7430lm/56W	10350lm/81W
2055	6320lm/50W	8710lm/69W	12130lm/98W

Wallwasher | Direct-Indirect

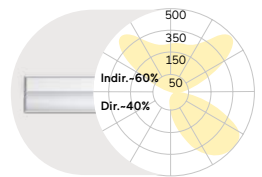

L mm	Lumen/Watt Medium Power	Lumen/Watt High Power
890	2910lm/26W	3980lm/37W
1182	3950lm/37W	5420lm/51W
1475	5000lm/45W	6850lm/63W
1765	6040lm/54W	8280lm/75W
2055	7090lm/65W	9710lm/91W

Lens Louvre | Direct

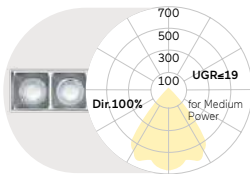

L mm	Lumen/Watt Medium Power	Lumen/Watt High Power
1002	2500lm/19W	3590lm/28W
1252	3120lm/23W	4500lm/34W
1502	3750lm/27W	5380lm/40W
1752	4370lm/31W	6280lm/46W
2002	5000lm/35W	7180lm/53W

Microprismatic | Direct

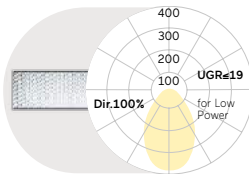

L mm	Lumen/Watt Low Power	Lumen/Watt Medium Power	Lumen/Watt High Power
890	1230lm/12W	1660lm/16W	2350lm/24W
1182	1640lm/16W	2210lm/21W	3130lm/31W
1475	2050lm/19W	2770lm/26W	3920lm/37W
1765	2450lm/22W	3320lm/30W	4700lm/44W
2055	2860lm/28W	3870lm/38W	5490lm/54W

Opal Diffuser | Direct

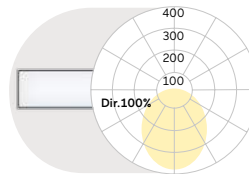

L mm	Lumen/Watt Low Power	Lumen/Watt Medium Power	Lumen/Watt High Power
890	1350lm/12W	1820lm/16W	2580lm/24W
1182	1790lm/16W	2430lm/21W	3440lm/31W
1475	2240lm/19W	3030lm/26W	4300lm/37W
1765	2690lm/22W	3640lm/30W	5160lm/44W
2055	3140lm/28W	4250lm/38W	6020lm/54W

Wallwasher | Direct

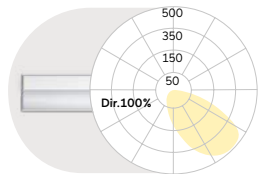

L mm	Lumen/Watt Medium Power	Lumen/Watt High Power
890	1130lm/15W	1540lm/21W
1182	1500lm/19W	2060lm/27W
1475	1880lm/23W	2570lm/33W
1765	2250lm/28W	3090lm/39W
2055	2630lm/34W	3600lm/47W

Lumen Values: Luminaire luminous flux at 4000K/CRI>80. Other configurations on request.

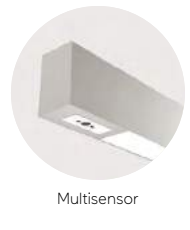
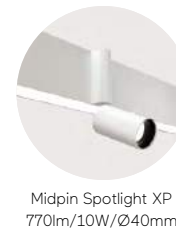
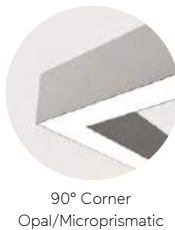

Matric System R4 | 55mm Suspended



DE LED-Pendelleuchte. Direkt-indirektstrahlend. Lichtkanal aus Aluminiumprofil mit 55mm Profilbreite. Millimetergenaue Längenfertigung nach Vorgabe möglich. Oberfläche natureloxiert oder weiß, graphit, schwarz, champagner oder kupferfarben lackiert. Weitere Oberflächenoptionen siehe Lightnet-Surface-Collection oder RAL nach Wahl. Direktanteil über Präzisionslinsen mit Abblendraster für breite rotationssymmetrische Lichtstärkeverteilung bei gleichzeitig hoher Blendungsbegrenzung (UGR<19) für Office Anwendungen. Abblendraster in verschiedenen Farbkombinationen erhältlich. Microprismenoptik aus Spezialacrylglas mit optimierter Blendungsbegrenzung für Office-Anwendungen. Satinierter Opaldiffusor für Allgemeinbeleuchtung mit max. Transmissionsgrad und homogener Lichtpunktauflösung. Wallwasher für homogene Beleuchtung vertikaler Flächen. Konverter in Leuchtgehäuse integriert, Lichtkammern für direktes und indirektes Licht getrennt schaltbar oder dimmbar (DALI, Casambi). Farbtemperatur 2200K, 2700K, 3000K, 3500K, 4000K, 6500K oder Tunable White (2700-6500K). Binning initial \leq MacAdam 3. Farbwiedergabe CRI>80, CRI>90 oder Full Spectrum. Stufenlos höhenverstellbare Y-Seilabhängung mit transparent ummantelter Zuleitung. Lackierung Baldachin passend Leuchtenkörper. Auf Anfrage: Integration von Stromschienen und Strahlern, Notlichtkomponenten, Sensortechnologie.

EN LED pendant luminaire. Direct-indirect light distribution. Light channel made of 55mm wide aluminium profile. Bespoke lengths are possible. Surface natural anodised or white, graphite, black, champagne or copper coated. Further surface options see Lightnet-Surface-Collection or RAL of your choice. Direct light using precision lenses with louvre for wide uniform symmetrical light distribution with high glare limitation (UGR<19) especially for workplaces. Louvre available in various colour finishes. Microprismatic screen made of special acrylic glass with optimized glare reduction especially for workplaces. Satin opal diffuser for general lighting with maximum transmittance and homogeneous lighting. Wallwasher for homogeneous illumination of vertical surfaces. Driver integrated into luminaire housing, light chambers for direct and indirect light separately switchable or dimmable (DALI, Casambi). Colour temperature 2200K, 2700K, 3000K, 3500K, 4000K, 6500K or Tunable White (2700-6500K). Binning \leq MacAdam 3. Colour rendering CRI>80, CRI>90 or Full Spectrum. Height-adjustable Y-cord suspension with transparent power supply cable. Colours ceiling rose match to luminaire body. On request: Integration of tracks and spotlights, emergency lighting components, sensor technology.

L R4 L B G-8 30 M-L1002-YB*

Product Family	L: Matric
Type	R4: Direct-Indirect
Optical System	A: Microprismatic, O: Opal Diffuser, L: Lens Louvre* G: Wallwasher, D: Opal Diffuser (Polycarbonate)**
Surface Finish	W: Snow White, E: Silver Anodised, U: Urban Graphite, B: Jet Black, H: Anodic Champagne, K: Satin Copper
Control Gear	G: Separately Switchable, U: Separately Dimmable DALI, C: Casambi, 6: DALI DT6 for TW [L1475-L2055], 8: DALI DT8 for TW
Colour Rendering	8: CRI>80, 9: CRI>90, F: Full Spectrum [except 2200K]
Colour Temperature	22: 2200K, 27: 2700K, 30: 3000K, 35: 3500K, 40: 4000K, 65: 6500K, TW: Tunable White 2700-6500K
Power	E: Low Power, M: Medium Power, H: High Power
Size	Luminaire Length in mm: L890, L1182, L1475, L1765, L2055 Luminaire Length in mm (Lens Louvre*): L1002, L1252, L1502, L1752, L2002
Suspension	Y: Y-Cord Suspension
Lens Louvre*	W: Snow White, A: Satin Silver, B: Jet Black, H: Anodic Champagne, K: Satin Copper, G: Satin Gold
On Request	90°Corner, Midpin Spotlights XM, Midpin Spotlights XP, Multisensor [L1182-L2055], Emergency Module [L1182-L2055]

**Opal Diffuser made of sustainable TruCircle Polycarbonate / Fire Rated - Glow wire flammability Index 950°C EN60695-2-12 / Tp(a). Luminous flux reduction of 10%



Lens Louvre Direct-Indirect			Microprismatic Direct-Indirect			Opal Diffuser Direct-Indirect			Asymmetrical Direct-Indirect				
L	Lumen/Watt	Lumen/Watt	L	Lumen/Watt	Lumen/Watt	Lumen/Watt	L	Lumen/Watt	Lumen/Watt	Lumen/Watt	L	Lumen/Watt	Lumen/Watt
mm	Medium Power	High Power	mm	Low Power	Medium Power	High Power	mm	Low Power	Medium Power	High Power	mm	Medium Power	High Power
1002	4300lm/34W	6050lm/48W	890	2370lm/22W	3260lm/30W	4540lm/42W	890	2490lm/22W	3420lm/30W	4770lm/42W	890	2730lm/26W	3730lm/37W
1252	5510lm/42W	7780lm/61W	1182	3200lm/28W	4410lm/39W	6140lm/55W	1182	3350lm/28W	4630lm/39W	6450lm/55W	1182	3700lm/37W	5070lm/51W
1502	6540lm/49W	9210lm/71W	1475	4040lm/35W	5560lm/48W	7750lm/68W	1475	4230lm/35W	5820lm/48W	8130lm/68W	1475	4670lm/45W	6400lm/63W
1752	7760lm/57W	10930lm/83W	1765	4870lm/41W	6710lm/56W	9350lm/81W	1765	5110lm/41W	7030lm/56W	9810lm/81W	1765	5640lm/54W	7740lm/75W
2002	8790lm/63W	12380lm/96W	2055	5700lm/50W	7860lm/69W	10960lm/98W	2055	5980lm/50W	8240lm/69W	11490lm/98W	2055	6620lm/65W	9070lm/91W

Lumen Values: Luminaire luminous flux at 4000K/CRI>80. Other configurations on request.



Matric System G5 | 81mm Suspended

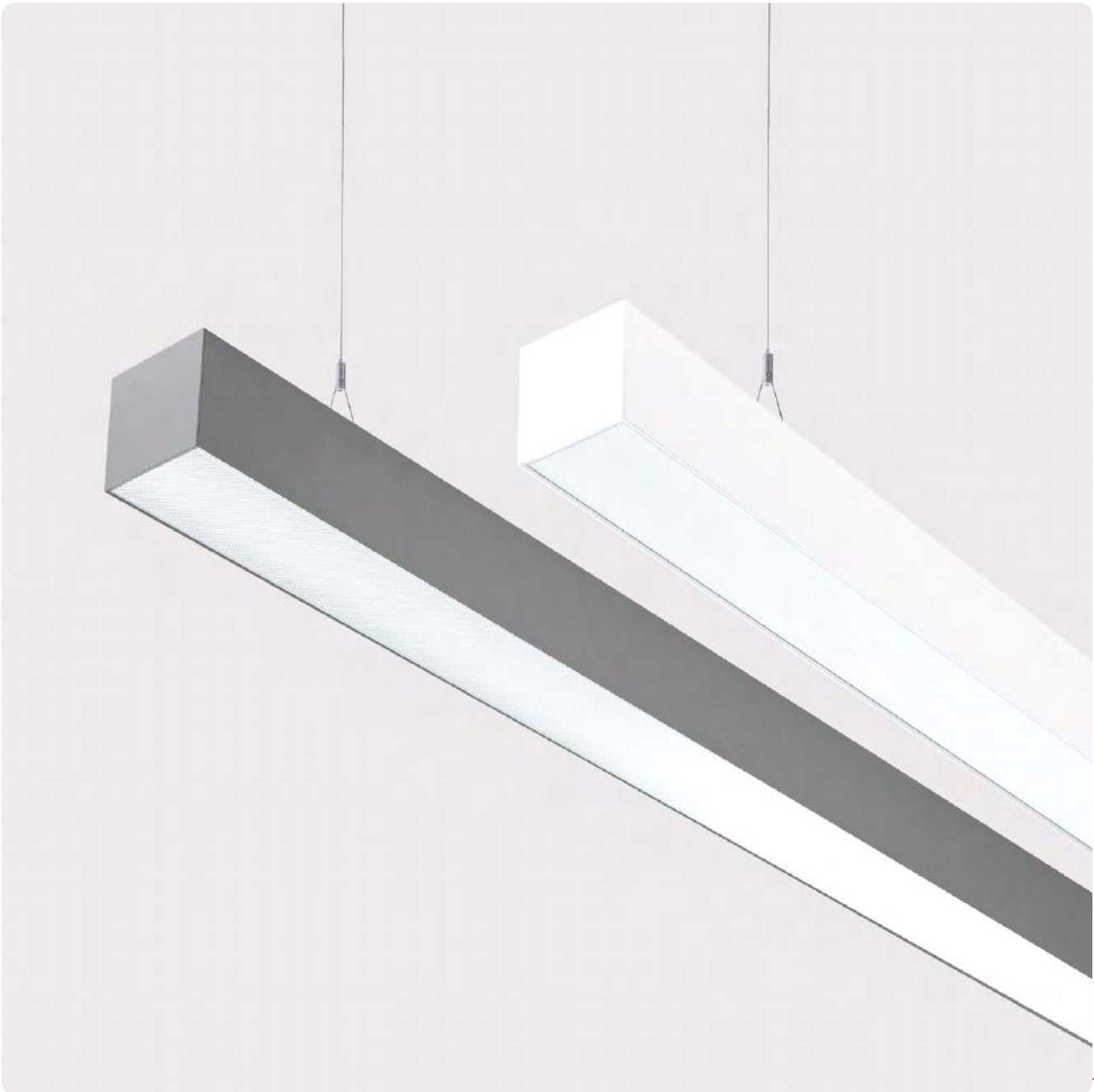

DE LED-Pendelleuchte. Direktstrahlend. Lichtkanal aus Aluminiumprofil mit 81mm Profillbreite. Millimetergenaue Längenfertigung nach Vorgabe möglich. Oberfläche natureloxiert oder weiß, graphit, schwarz, champagner oder kupferfarben lackiert. Weitere Oberflächenoptionen siehe Lightnet-Surface-Collection oder RAL nach Wahl. Microprismenoptik aus Spezialacrylglas und Satin-Louvre aus Aluminium mit optimierter Blendungsbegrenzung speziell für Office-Anwendungen. Satinierter Opaldiffusor für Allgemeinbeleuchtung mit max. Transmissionsgrad und homogener Lichtpunktauflösung. Wallwasher für homogene Beleuchtung vertikaler Flächen. Konverter in Leuchtgehäuse integriert, wahlweise einfach schaltbar oder stufenlos dimmbar (DALI, Touch-Dim, Casambi). Farbtemperatur 2200K, 2700K, 3000K, 3500K, 4000K, 6500K oder Tunable White (2700-6500K). Binning initial \leq MacAdam 3. Farbwiedergabe CRI $>$ 80, CRI $>$ 90 oder Full Spectrum. Stufenlos höhenverstellbare Y-Seilabhangung mit transparent ummantelter Zuleitung. Lackierung Baldachin passend Leuchtenkorper. Auf Anfrage: Integration von Strahlern, Notlichtkomponenten, Sensortechnologie.

EN LED pendant luminaire. Direct only light distribution. Light channel made of 81mm wide aluminium profile. Bespoke lengths are possible. Surface natural anodised or white, graphite, black, champagne or copper coated. Further surface options see Lightnet-Surface-Collection or RAL of your choice. Microprismatic screen made of special acrylic glass and satin Louvre made of aluminum with optimized glare reduction especially for workplaces. Satin opal diffuser for general lighting with maximum transmittance and homogeneous lighting. Wallwasher for homogeneous illumination of vertical surfaces. Driver integrated into luminaire housing, optionally switchable or dimmable (DALI, Touch-Dim, Casambi). Colour temperature 2200K, 2700K, 3000K, 3500K, 4000K, 6500K or Tunable White (2700-6500K). Binning \leq MacAdam 3. Colour rendering CRI $>$ 80, CRI $>$ 90 or Full Spectrum. Height-adjustable Y-cord suspension with transparent power supply cable. Colours ceiling rose match to luminaire body. On request: Integration of spotlights, emergency lighting components, sensor technology.

L G50 WE - 830 M - L890-Y

Product Family	L: Matric
Type	G5: Direct only
Optical System	A: Microprismatic, O: Opal Diffuser, M: Satin Louvre, G: Wallwasher
Surface Finish	W: Snow White, V: Ivory White, E: Silver Anodised, U: Urban Graphite, B: Jet Black, H: Anodic Champagne, K: Satin Copper
Control Gear	E: On/Off, L: DALI, H: Touch-Dim, C: Casambi, 6: DALI DT6 for TW, 8: DALI DT8 for TW
Colour Rendering	8: CRI>80, 9: CRI>90, F: Full Spectrum [except 2200K]
Colour Temperature	22: 2200K, 27: 2700K, 30: 3000K, 35: 3500K, 40: 4000K, 65: 6500K, TW: Tunable White 2700-6500K
Power	E: Low Power, M: Medium Power, H: High Power
Size	Luminaire Length in mm: L890, L1182, L1475, L1765, L2055
Suspension	Y: Y-Cord Suspension
On Request	90° Corner, Midpin Downlight XD, Midpin Spotlights XM, Midpin Spotlights XP, Multisensor [L1182-L2055], Emergency Module [L1182-L2055]



Microprismatic | Direct

Opal Diffuser | Direct

Satin Louvre | Direct

Wallwasher | Direct

L mm	Lumen/Watt			L mm	Lumen/Watt			L mm	Lumen/Watt		L mm	Lumen/Watt
	Low Power	Medium Power	High Power		Low Power	Medium Power	High Power		Medium Power	High Power		
890	1510lm/15W	2070lm/21W	3020lm/31W	890	1760lm/15W	2430lm/21W	3530lm/31W	890	1900lm/21W	2770lm/31W	890	1770lm/21W
1182	2010lm/19W	2760lm/26W	4020lm/40W	1182	2350lm/19W	3230lm/26W	4710lm/40W	1182	2530lm/26W	3690lm/40W	1182	2360lm/27W
1475	2510lm/23W	3450lm/32W	5030lm/49W	1475	2940lm/23W	4040lm/32W	5890lm/49W	1475	3170lm/32W	4610lm/49W	1475	2950lm/33W
1765	3010lm/27W	4140lm/38W	6030lm/59W	1765	3530lm/27W	4850lm/38W	7070lm/59W	1765	3800lm/38W	5530lm/59W	1765	3540lm/39W
2055	3510lm/34W	4830lm/47W	7040lm/71W	2055	4120lm/34W	5660lm/47W	8240lm/71W	2055	4430lm/47W	6450lm/71W	2055	4130lm/47W

Lumen Values: Luminaire luminous flux at 4000K/CRI>80. Other configurations on request.

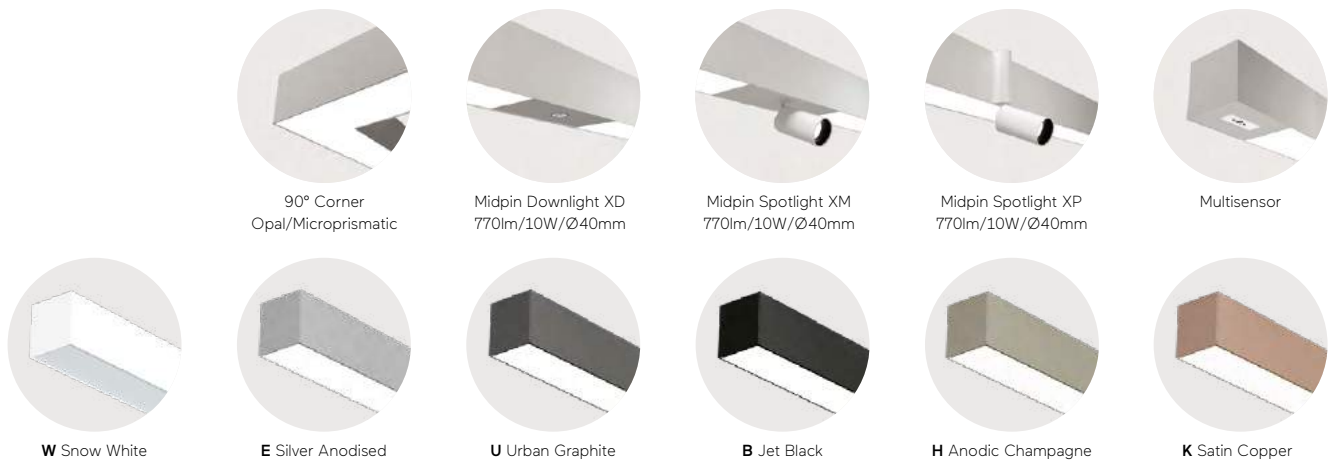
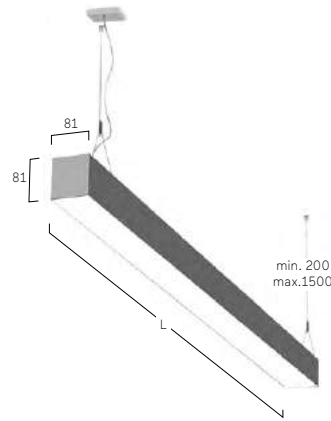

Matric G6/R6 | System 81mm Suspended



DE LED-Pendelleuchte. Direkt-indirekt oder rein direktstrahlend. Lichtkanal aus Aluminiumprofil mit 81mm Profildbreite und 60mm Bauhöhe. Millimetergenaue Längenfertigung nach Vorgabe möglich. Oberfläche natureloxiert oder weiß, graphit, schwarz, champagner oder kupferfarben lackiert. Weitere Oberflächenoptionen siehe Lightnet-Surface-Collection oder RAL nach Wahl. Microprismenoptik aus Spezialacrylglas mit optimierter Blendungsbegrenzung für Office-Anwendungen. Satiniertes Opaldiffusor für Allgemeinbeleuchtung mit max. Transmissionsgrad und homogener Lichtpunktauflösung. Wallwasher für homogene Beleuchtung vertikaler Flächen. Indirektanteil mit innovativer Linsentechnologie für breitstrahlende Deckenaufhellung. Konverter in Leuchtgehäuse integriert, wahlweise einfach schaltbar oder stufenlos dimmbar (DALI, Touch-Dim, Casambi). Farbtemperatur 2200K, 2700K, 3000K, 3500K, 4000K, 6500K oder Tunable White (2700-6500K). Binning initial \leq MacAdam 3. Farbwiedergabe CRI $>$ 80, CRI $>$ 90 oder Full Spectrum. Stufenlos höhenverstellbare Y-Seilabhängung mit transparent ummantelter Zuleitung. Lackierung Baldachin passend Leuchtenkörper. Auf Anfrage: Integration von Strahlern, Notlichtkomponenten, Sensortechnologie.

EN LED pendant luminaire. Direct-indirect or direct-only light distribution. Light channel made of 81mm wide by 60mm high aluminium profile with. Bespoke lengths are possible. Surface natural anodised or white, graphite, black, champagne or copper coated. Further surface options see Lightnet-Surface-Collection or RAL of your choice. Microprismatic screen made of special acrylic glass with optimized glare reduction especially for workplaces. Satin opal diffuser for general lighting with maximum transmittance and homogeneous lighting. Wallwasher for homogeneous illumination of vertical surfaces. Indirect light with innovative lens technology for wide-angle ceiling illumination. Driver integrated into luminaire housing, optionally switchable or dimmable (DALI, Touch-Dim, Casambi). Colour temperature 2200K, 2700K, 3000K, 3500K, 4000K, 6500K or Tunable White (2700-6500K). Binning \leq MacAdam 3. Colour rendering CRI $>$ 80, CRI $>$ 90 or Full Spectrum. Height-adjustable Y-cord suspension with transparent power supply cable. Colours ceiling rose match to luminaire body. On request: Integration of spotlights, emergency lighting components, sensor technology.

L G60 WE - 830 M - L890-Y

Product Family **L:** Matric

Type **G6:** Direct only, **R6:** Direct-indirect

Optical System **A:** Microprismatic, **O:** Opal Diffuser, **J:** Wallwasher

Surface Finish **W:** Snow White, **V:** Ivory White, **E:** Silver Anodised, **U:** Urban Graphite, **B:** Jet Black, **H:** Anodic Champagne, **K:** Satin Copper

Control Gear **E:** On/Off, **L:** DALI, **H:** Touch-Dim, **C:** Casambi, **6:** DALI DT6 for TW, **8:** DALI DT8 for TW

Colour Rendering **8:** CRI>80, **9:** CRI>90, **F:** Full Spectrum [except 2200K]

Colour Temperature **22:** 2200K, **27:** 2700K, **30:** 3000K, **35:** 3500K, **40:** 4000K, **65:** 6500K, **TW:** Tunable White 2700-6500K

Power **E:** Low Power, **M:** Medium Power, **H:** High Power

Size Luminaire Length in mm: **L890, L1182, L1475, L1765, L2055**

Suspension **Y:** Y-Cord Suspension

On Request 90°Corner, Midpin Downlight XD, Midpin Spotlights XM, Midpin Spotlights XP, Multisensor [L1182-L2055], Emergency Module [L1182-L2055]



Microprismatic | Direct-Indirect

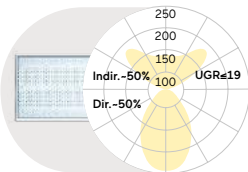

Microprismatic | Direct

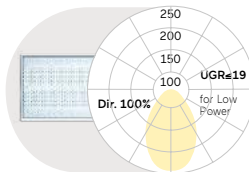

Opal Diffuser | Direct-Indirect

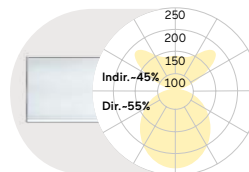

Opal Diffuser | Direct

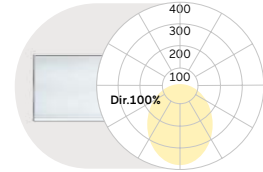

L mm	Lumen/Watt			L mm	Lumen/Watt			L mm	Lumen/Watt			L mm	Lumen/Watt		
	Low Power	Medium Power	High Power		Low Power	Medium Power	High Power		Low Power	Medium Power	High Power		Low Power	Medium Power	High Power
890	2990lm/26W	4080lm/34W	5520lm/46W	890	1580lm/15W	2110lm/19W	2840lm/26W	890	3330lm/26W	4530lm/34W	6140lm/46W	890	1920lm/15W	2560lm/19W	3460lm/26W
1182	3980lm/33W	5440lm/44W	7370lm/61W	1182	2100lm/19W	2810lm/25W	3790lm/34W	1182	4440lm/33W	6050lm/44W	8190lm/61W	1182	2560lm/19W	3420lm/25W	4610lm/34W
1475	4980lm/40W	6800lm/54W	9210lm/74W	1475	2630lm/23W	3510lm/31W	4740lm/42W	1475	5550lm/40W	7560lm/54W	10230lm/74W	1475	3200lm/23W	4270lm/31W	5760lm/42W
1765	5970lm/47W	8160lm/64W	11060lm/88W	1765	3150lm/27W	4220lm/36W	5690lm/49W	1765	6660lm/47W	9070lm/64W	12290lm/88W	1765	3840lm/27W	5130lm/36W	6920lm/49W
2055	6970lm/56W	9520lm/76W	12900lm/104W	2055	3680lm/31W	4920lm/42W	6640lm/57W	2055	7760lm/56W	10580lm/76W	14330lm/104W	2055	4470lm/31W	5980lm/42W	8070lm/57W

Wallwasher | Direct-Indirect

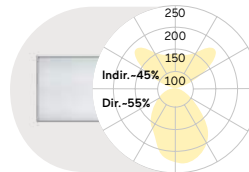

Wallwasher | Direct

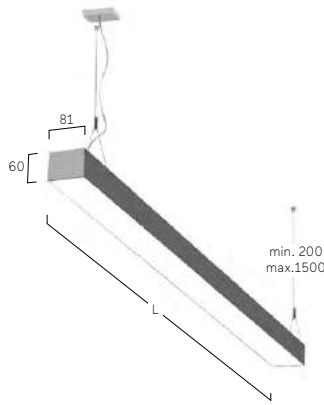
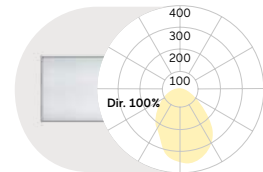

L mm	Lumen/Watt			L mm	Lumen/Watt		
	Low Power	Medium Power	High Power		Low Power	Medium Power	High Power
890	3060lm/26W	4180lm/34W	5660lm/46W	890	1650lm/15W	2210lm/19W	2980lm/26W
1182	4080lm/33W	5570lm/44W	7550lm/61W	1182	2200lm/19W	2940lm/25W	3970lm/34W
1475	5100lm/40W	6970lm/54W	9430lm/74W	1475	2750lm/23W	3680lm/31W	4960lm/42W
1765	6120lm/47W	8360lm/64W	11330lm/88W	1765	3300lm/27W	4420lm/36W	5960lm/49W
2055	7140lm/56W	9750lm/76W	13210lm/104W	2055	3850lm/31W	5150lm/42W	6950lm/57W

Lumen Values: Luminaire luminous flux at 4000K/CRI>80. Other configurations on request.



90° Corner
Opal/Microprismatic



Midpin Downlight XD
770lm/10W/Ø40mm



Midpin Spotlight XM
770lm/10W/Ø40mm



Midpin Spotlight XP
770lm/10W/Ø40mm



Multisensor

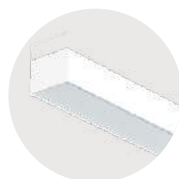

W Snow White

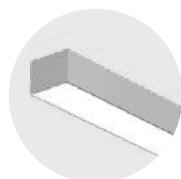

E Silver Anodised

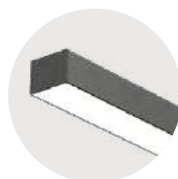

U Urban Graphite



B Jet Black

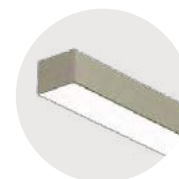

H Anodic Champagne



K Satin Copper

Matric Square Suspended





Ichthuskerk, Boskoop, Netherlands
Matric R4

Kindergarten, Vach, Germany
Matric R1 Square

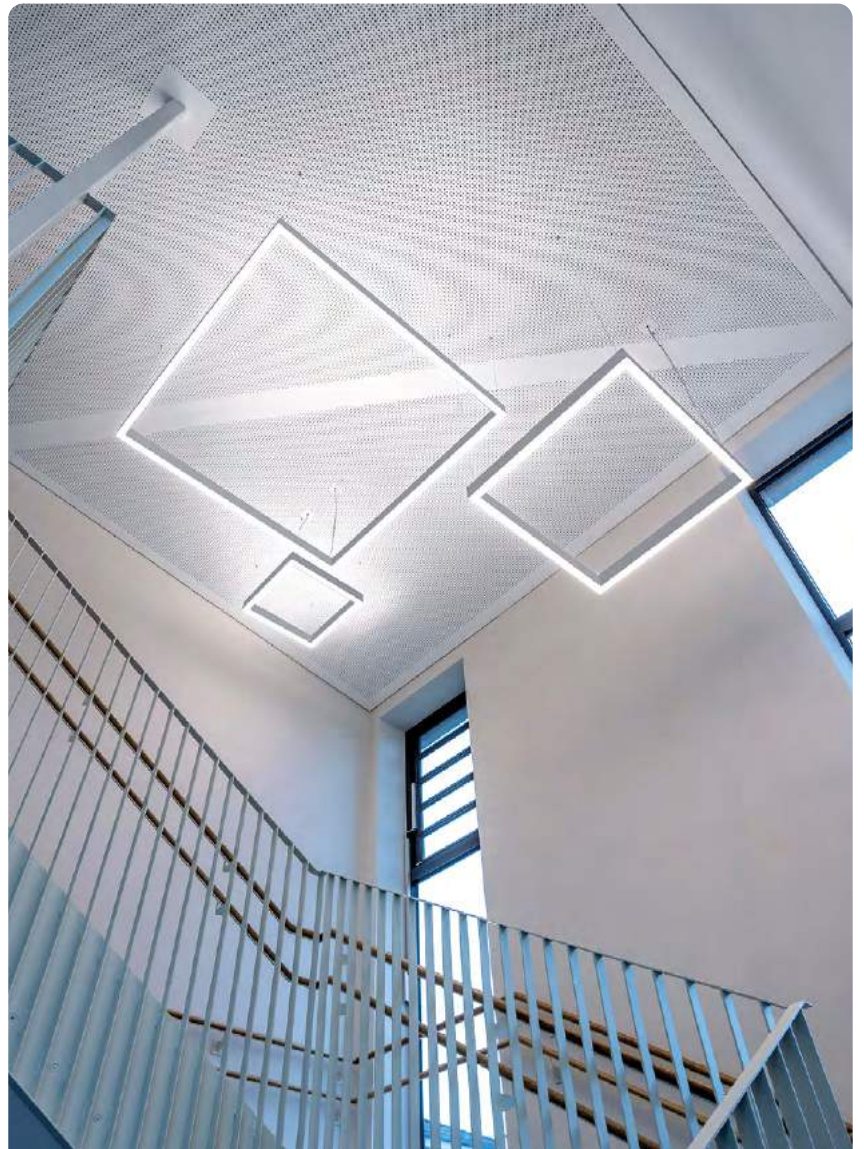

Matric Square GX/RX | System 40mm Suspended



DE LED-Pendelleuchte. Direkt-indirekt oder rein direktstrahlend. Leuchtenkörper aus Aluminiumprofil mit 40mm Profildbreite. Oberfläche silber oder weiß, graphit, schwarz, champagner oder kupferfarben lackiert. Weitere Oberflächenoptionen siehe Lightnet-Surface-Collection oder RAL nach Wahl. Direktanteil über Präzisionslinsen mit Abblendraster für breite rotations-symmetrische Lichtstärkeverteilung bei gleichzeitig hoher Blendungsbegrenzung (UGR<19) für Office Anwendungen. Abblendraster in verschiedenen Farbkombinationen erhältlich. Microprismenoptik aus Spezialacrylglas mit optimierter Blendungsbegrenzung für Office-Anwendungen. Satinierter Opaldiffusor für Allgemeinbeleuchtung mit max. Transmissionsgrad und homogener Lichtpunktauflösung. Indirektanteil mit innovativer Linsentechnologie für breitstrahlende Deckenaufhellung. Konverter in Leuchtgehäuse integriert, wahlweise einfach schaltbar oder stufenlos dimmbar (DALI, Touch-Dim, Casambi). Farbtemperatur 2200K, 2700K, 3000K, 3500K, 4000K, 6500K oder Tunable White (2700-6500K). Binning initial \leq MacAdam 3. Farbwiedergabe CRI>80, CRI>90 oder Full Spectrum. Stufenlos höhenverstellbare Parallelseil-Abhängung mit transparent ummantelter Zuleitung. Lackierung Baldachin passend Leuchtenkörper. Auf Anfrage: Integration von Stromschienen und Strahlern, Notlichtkomponenten, Sensortechnologie.

EN LED pendant luminaire. Direct-indirect or direct-only light distribution. Luminaire body made of 40mm wide aluminium profile. Surface silver or white, graphite, black, champagne or copper coated. Further surface options see Lightnet-Surface-Collection or RAL of your choice. Direct light using precision lenses with louvre for wide uniform symmetrical light distribution with high glare limitation (UGR<19) especially for workplaces. Louvre available in various colour finishes. Microprismatic screen made of special acrylic glass with optimized glare reduction especially for workplaces. Satin opal diffuser for general lighting with maximum transmittance and homogeneous lighting. Indirect light with innovative lens technology for wide-angle ceiling illumination. Driver integrated into luminaire housing, optionally switchable or dimmable (DALI, Touch-Dim, Casambi). Colour temperature 2200K, 2700K, 3000K, 3500K, 4000K, 6500K or Tunable White (2700-6500K). Binning \leq MacAdam 3. Colour rendering CRI>80, CRI>90 or Full Spectrum. Height-adjustable parallel cord suspension with transparent power supply cable. Colours ceiling rose match to luminaire body. On request: Integration of tracks and spotlights, emergency lighting components, sensor technology.

LGX A S E - 8 30 M - Q930 - K

Product Family	L: Matric
Type	GX: Direct only, RX: Direct-Indirect
Optical System	A: Microprismatic, O: Opal Diffuser
Surface Finish	W: Snow White, S: Radiant Silver, U: Urban Graphite, B: Jet Black, H: Anodic Champagne, K: Satin Copper
Control Gear	E: On/Off, L: DALI, H: Touch-Dim, C: Casambi, 6: DALI DT6 for TW, 8: DALI DT8 for TW
Colour Rendering	8: CRI>80, 9: CRI>90, F: Full Spectrum [except 2200K]
Colour Temperature	22: 2200K, 27: 2700K, 30: 3000K, 35: 3500K, 40: 4000K, 65: 6500K, TW: Tunable White 2700-6500K
Power	E: Low Power, M: Medium Power, H: High Power
Size	Square Size in mm: Q640, Q930, Q1220, Q1510
Suspension	K: Parallel Suspension
On Request	Midpin Downlight XD, Midpin Spotlights XM, Midpin Spotlights XP, 48V-Track, Multisensor, Emergency Module



Microprismatic | Direct-Indirect

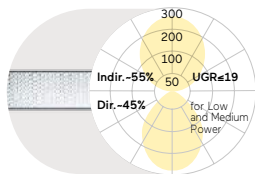

Microprismatic | Direct

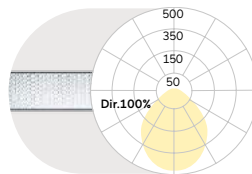

Opal Diffuser | Direct-Indirect

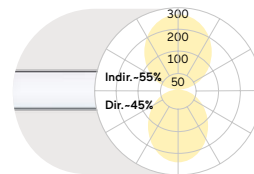

Opal Diffuser | Direct

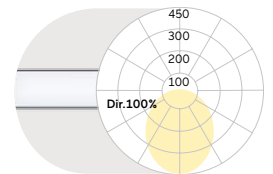

Q mm	Lumen/Watt Low Power	Lumen/Watt Medium Power	Lumen/Watt High Power	Q mm	Lumen/Watt Low Power	Lumen/Watt High Power	Q mm	Lumen/Watt Medium Power	Lumen/Watt High Power	Q mm	Lumen/Watt Medium Power	Lumen/Watt High Power
640	5210lm/48W	7120lm/63W	9360lm/83W	640	2450lm/24W	4400lm/42W	640	7340lm/63W	9660lm/83W	640	3460lm/31W	4700lm/42W
930	8100lm/69W	11060lm/93W	14530lm/124W	930	3680lm/34W	6600lm/60W	930	11390lm/93W	14980lm/124W	930	5190lm/44W	7050lm/60W
1220	10980lm/99W	15010lm/133W	19700lm/174W	1220	4910lm/48W	8790lm/83W	1220	15450lm/133W	20310lm/174W	1220	6920lm/62W	9400lm/83W
1510	13860lm/120W	18940lm/162W	24870lm/214W	1510	6130lm/57W	10990lm/101W	1510	19500lm/162W	25630lm/214W	1510	8650lm/74W	11750lm/101W

Lumen Values: Luminaire luminous flux at 4000K/CRI>80. Other configurations on request.

Parallel Suspension

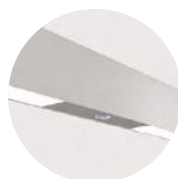
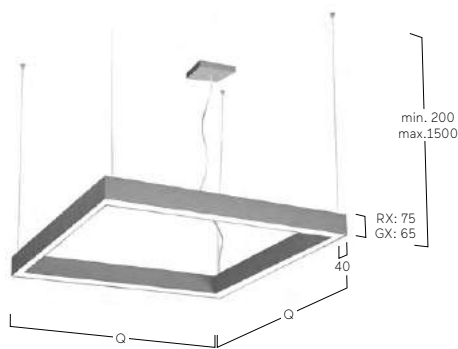

Midpin Downlight XD
310lm/5W/Ø21mm



Midpin Spotlight XM
770lm/10W/Ø40mm



Midpin Spotlight XP
770lm/10W/Ø40mm



48V-Track



Multisensor



W Snow White



S Radiant Silver



U Urban Graphite



B Jet Black



H Anodic Champagne



K Satin Copper

Matric Square Acoustic Suspended





Rutheneum, Gera, Germany
Matric Square Acoustic R1



Matric Square Acoustic GX/RX | System 40mm Suspended



DE LED-Pendelleuchte. Direkt-indirekt oder rein direktstrahlend. Leuchtenkörper aus Aluminiumprofil mit 40mm Profildbreite. Oberfläche silber oder weiß, graphit, schwarz, champagner oder kupferfarben lackiert. Weitere Oberflächenoptionen siehe Lightnet-Surface-Collection oder RAL nach Wahl. Innenliegender Schallabsorber für breites Frequenzspektrum zur Reduktion der Nachhallzeit sowie ein angenehmes Raumklima aus Schafschurwolle aus ökologischer Haltung. Raumseitige Kaschierung wahlweise aus Schurwolle in verschiedenen Farben, aus microperforiertem Stahl in Leuchtenfarbe lackiert oder aus grünem Moos. Direktanteil über Präzisionslinsen mit Abblendraster für breite rotationssymmetrische Lichtstärkeverteilung bei gleichzeitig hoher Blendungsbegrenzung (UGR<19). Abblendraster in verschiedenen Farbkombinationen erhältlich. Microprismenoptik aus Spezialacrylglas mit optimierter Blendungsbegrenzung für Office-Anwendungen. Satinierter Opaldiffusor für Allgemeinbeleuchtung. Konverter in Leuchtgehäuse integriert, wahlweise einfach schaltbar oder stufenlos dimmbar (DALI, Touch-Dim, Casambi). Farbtemperatur 2200K, 2700K, 3000K, 3500K, 4000K, 6500K oder Tunable White (2700-6500K). Binning initial \leq MacAdam 3. Farbwiedergabe CRI>80, CRI>90 oder Full Spectrum. Stufenlos höhenverstellbare Parallelseil-Abhängung mit transparent ummantelter Zuleitung.

EN LED pendant luminaire. Direct-indirect or direct-only light distribution. Luminaire body made of 40mm wide aluminium profile. Surface silver or white, graphite, black, champagne or copper coated. Further surface options see Lightnet-Surface-Collection or RAL of your choice. Internal sound absorber for a wide frequency spectrum, reducing the reverberation time. Made of ecologically sourced sheep's wool available in various colours, microperforated steel in luminaire colour or green moss. Direct light using precision lenses with louvre for wide uniform symmetrical light distribution with high glare limitation (UGR<19). Louvre available in various colour finishes. Microprismatic diffuser made of special acrylic glass with optimized glare reduction especially for workplaces. Satin opal diffuser for general lighting with maximum transmittance and homogeneous lighting. Driver integrated into luminaire housing, optionally switchable or dimmable (DALI, Touch-Dim, Casambi). Colour temperature 2200K, 2700K, 3000K, 3500K, 4000K, 6500K or Tunable White (2700-6500K). Binning \leq MacAdam 3. Colour rendering CRI>80, CRI>90 or Full Spectrum. Height-adjustable parallel cord suspension with transparent power supply cable. Delivery of system in one piece. Corners laser welded.

LGX A S E-8 30 M-Q930-K-BW

- Product Family **L:** Matric
- Type **GX:** Direct only, **RX:** Direct-Indirect
- Optical System **A:** Microprismatic, **O:** Opal Diffuser
- Surface Finish **W:** Snow White, **S:** Radiant Silver, **U:** Urban Graphite, **B:** Jet Black, **H:** Anodic Champagne, **K:** Satin Copper
- Control Gear **E:** On/Off, **L:** DALI, **H:** Touch-Dim, **C:** Casambi, **6:** DALI DT6 for TW, **8:** DALI DT8 for TW
- Colour Rendering **8:** CRI>80, **9:** CRI>90, **F:** Full Spectrum [except 2200K]
- Colour Temperature **22:** 2200K, **27:** 2700K, **30:** 3000K, **35:** 3500K, **40:** 4000K, **65:** 6500K, **TW:** Tunable White 2700-6500K
- Power **E:** Low Power, **M:** Medium Power, **H:** High Power
- Size Square Size in mm: **Q640, Q930, Q1220, Q1510**
- Suspension **K:** Parallel Suspension
- Acoustic Absorb. **AW:** Micro Perforated, **BW:** Beige Wool, **ZW:** Green Wool, **GW:** Graphite Wool, **AM:** Green Moss
- On Request Midpin Downlight XD, Midpin Spotlights XM, Multisensor, Emergency Module



Microprismatic | Direct-Indirect

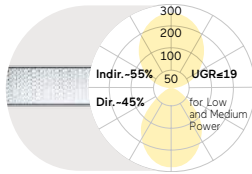

Microprismatic | Direct

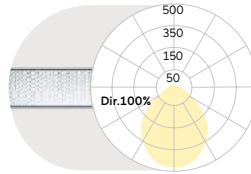

Opal Diffuser | Direct-Indirect

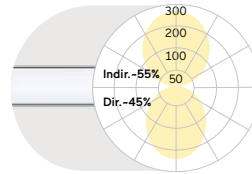

Opal Diffuser | Direct

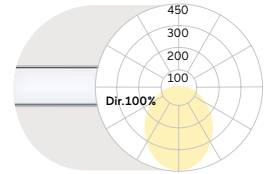

Q mm	Lumen/Watt			Q mm	Lumen/Watt			Q mm	Lumen/Watt			Q mm	Lumen/Watt		
	Low Power	Medium Power	High Power		Low Power	High Power	Low Power		High Power	Medium Power	High Power		Medium Power	High Power	
640	5210lm/48W	7120lm/63W	9360lm/83W	640	2450lm/24W	4400lm/42W	640	7340lm/63W	9660lm/83W	640	3460lm/31W	4700lm/42W	640	3460lm/31W	4700lm/42W
930	8100lm/69W	11060lm/93W	14530lm/124W	930	3680lm/34W	6600lm/60W	930	11390lm/93W	14980lm/124W	930	5190lm/44W	7050lm/60W	930	5190lm/44W	7050lm/60W
1220	10980lm/99W	15010lm/133W	19700lm/174W	1220	4910lm/48W	8790lm/83W	1220	15450lm/133W	20310lm/174W	1220	6920lm/62W	9400lm/83W	1220	6920lm/62W	9400lm/83W
1510	13860lm/120W	18940lm/162W	24870lm/214W	1510	6130lm/57W	10990lm/101W	1510	19500lm/162W	25630lm/214W	1510	8650lm/74W	11750lm/101W	1510	8650lm/74W	11750lm/101W

Lumen Values: Luminaire luminous flux at 4000K/CRI>80. Other configurations on request.

Parallel Suspension

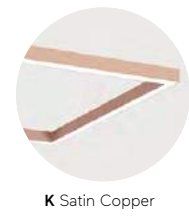
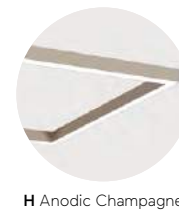
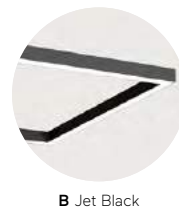
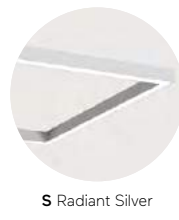
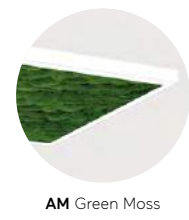
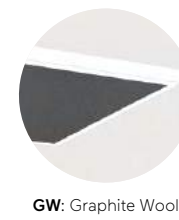
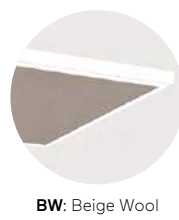
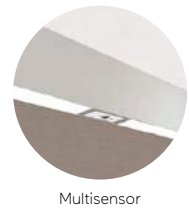
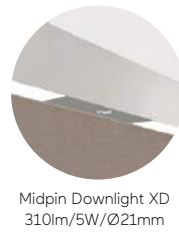
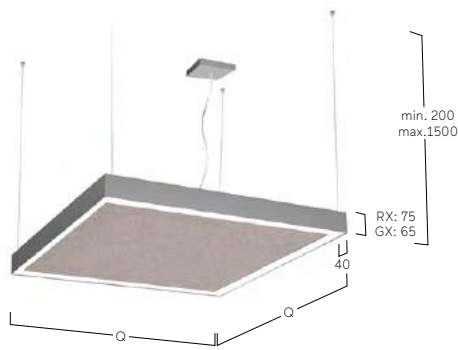

Vision Gen. 4 G4/P4 | Suspended



DE LED-Pendelleuchte. Direkt-indirekt oder rein direktstrahlend. Leuchtenkörper aus Aluminiumprofil mit 125mm Profilbreite und 40mm Bauhöhe. Millimetergenaue Längenfertigung nach Vorgabe möglich. Oberfläche natureloxiert oder weiß, graphit, schwarz, champagner oder kupferfarben lackiert. Weitere Oberflächenoptionen siehe Lightnet-Surface-Collection oder RAL nach Wahl. Direktanteil über Präzisionslinsen mit Abblendraster für breite rotationssymmetrische Lichtstärkeverteilung bei gleichzeitig hoher Blendungsbegrenzung (UGR<19) für Office Anwendungen. Abblendraster in verschiedenen Farbkombinationen erhältlich. Microprismenoptik aus Spezialacrylglas mit optimierter Blendungsbegrenzung für Office-Anwendungen. Satiniertes Opaldiffusor für Allgemeinbeleuchtung mit max. Transmissionsgrad und homogener Lichtpunktauflösung. Wallwasher für homogene Beleuchtung vertikaler Flächen. Konverter in Leuchtengehäuse integriert, wahlweise einfach schaltbar oder stufenlos dimmbar (DALI, Touch-Dim, Casambi). Farbtemperatur 2200K, 2700K, 3000K, 3500K, 4000K, 6500K oder Tunable White (2700-6500K). Binning initial \leq MacAdam 3. Farbwiedergabe CRI>80, CRI>90 oder Full Spectrum. Stufenlos höhenverstellbare Y- oder Parallel-Seilabhängung mit transparent ummantelter Zuleitung. Lackierung Baldachin passend Leuchtenkörper. Auf Anfrage: Integration von Stromschienen, Notlicht- & Sensortechnologie.

EN LED pendant luminaire. Direct-indirect or direct-only light distribution. Luminaire body made of 125mm wide by 40mm high aluminium profile. Bespoke lengths are possible. Surface natural anodised or white, graphite, black, champagne or copper coated. Further surface options see Lightnet-Surface-Collection or RAL of your choice. Direct light using precision lenses with louvre for wide uniform symmetrical light distribution with high glare limitation (UGR<19) especially for workplaces. Louvre available in various colour finishes. Microprismatic screen made of special acrylic glass with optimized glare reduction especially for workplaces. Satin opal diffuser for general lighting with maximum transmittance and homogeneous lighting. Wallwasher for homogeneous illumination of vertical surfaces. Driver integrated into luminaire housing, optionally switchable or dimmable (DALI, Touch-Dim, Casambi). Colour temperature 2200K, 2700K, 3000K, 3500K, 4000K, 6500K or Tuneable White (2700-6500K). Binning \leq MacAdam 3. Colour rendering CRI>80, CRI>90 or Full Spectrum. Height-adjustable Y- or parallel cord suspension with transparent power supply cable. Colours ceiling rose match to luminaire body. On request: Integration of tracks, emergency light & sensor technology.

VP4 LWE-830M-L1254-YA*

Product Family	V: Vision
Type	G4: Direct only, P4: Direct-Indirect
Optical System	L: Lens Louvre*, A: Microprismatic, O: Opal Diffuser, D: Opal Diffuser (Polycarbonate)**, J: Wallwasher
Surface Finish	W: Snow White, E: Silver Anodised, U: Urban Graphite, B: Jet Black, H: Anodic Champagne, K: Satin Copper
Control Gear	E: On/Off, L: DALI, H: Touch-Dim, C: Casambi, 6: DALI DT6 for TW, 8: DALI DT8 for TW
Colour Rendering	8: CRI>80, 9: CRI>90, F: Full Spectrum [except 2200K]
Colour Temperature	22: 2200K, 27: 2700K, 30: 3000K, 35: 3500K, 40: 4000K, 65: 6500K, TW: Tunable White 2700-6500K
Power	E: Low Power, M: Medium Power, H: High Power
Size	Luminaire length in mm [Microprismatic, Opal Diffuser, Wallwasher]: L890, L1182, L1475, L1765, L2055 Luminaire length in mm [Lens Louvre]: L1004, L1254, L1504, L1754, L2004
Suspension	K: Parallel Suspension, Y: Y-Cord Suspension
Lens Louvre*	W: Snow White, A: Satin Silver, B: Jet Black, H: Anodic Champagne, K: Satin Copper, G: Satin Gold

**Opal Diffuser made of sustainable TruCircle Polycarbonate / Fire Rated - Glow wire flammability Index 950°C EN60695-2-12 / Tp(a). Luminous flux reduction of 10%



Lens Louvre Direct-Indirect			Microprismatic Direct-Indirect			Opal Diffuser Direct-Indirect			Wallwasher Direct-Indirect				
L mm	Lumen/Watt Medium Power	Lumen/Watt High Power	L mm	Lumen/Watt Low Power	Lumen/Watt Medium Power	Lumen/Watt High Power	L mm	Lumen/Watt Low Power	Lumen/Watt Medium Power	Lumen/Watt High Power	L mm	Lumen/Watt Medium Power	Lumen/Watt High Power
1004	4470lm/34W	6270lm/48W	890	2640lm/23W	3630lm/31W	5030lm/43W	890	2760lm/23W	3790lm/31W	5260lm/43W	890	3470lm/31W	4810lm/43W
1254	5750lm/42W	8080lm/61W	1182	3520lm/29W	4840lm/40W	6710lm/56W	1182	3670lm/29W	5060lm/40W	7020lm/56W	1182	4630lm/40W	6420lm/56W
1504	7040lm/50W	9850lm/73W	1475	4400lm/35W	6060lm/48W	8390lm/69W	1475	4590lm/35W	6320lm/48W	8770lm/69W	1475	5790lm/48W	8020lm/69W
1754	8310lm/58W	11650lm/85W	1765	5270lm/41W	7260lm/57W	10070lm/82W	1765	5510lm/41W	7580lm/57W	10530lm/82W	1765	6940lm/57W	9620lm/82W
2004	9600lm/69W	13440lm/100W	2055	6150lm/52W	8470lm/71W	11750lm/99W	2055	6430lm/52W	8850lm/71W	12280lm/99W	2055	8100lm/71W	11220lm/99W

Lens Louvre Direct			Microprismatic Direct			Opal Diffuser Direct			Wallwasher Direct				
L mm	Lumen/Watt Medium Power	Lumen/Watt High Power	L mm	Lumen/Watt Low Power	Lumen/Watt Medium Power	Lumen/Watt High Power	L mm	Lumen/Watt Low Power	Lumen/Watt Medium Power	Lumen/Watt High Power	L mm	Lumen/Watt Medium Power	Lumen/Watt High Power
1004	2500lm/19W	3590lm/28W	890	1230lm/12W	1660lm/16W	2350lm/23W	890	1350lm/12W	1820lm/16W	2580lm/23W	890	1500lm/16W	2130lm/23W
1254	3120lm/23W	4500lm/34W	1182	1640lm/15W	2210lm/20W	3130lm/29W	1182	1790lm/15W	2430lm/20W	3440lm/29W	1182	2000lm/20W	2840lm/29W
1504	3750lm/27W	5380lm/40W	1475	2050lm/18W	2770lm/25W	3920lm/36W	1475	2240lm/18W	3030lm/25W	4300lm/36W	1475	2500lm/25W	3550lm/36W
1754	4370lm/31W	6280lm/46W	1765	2450lm/22W	3320lm/29W	4700lm/43W	1765	2690lm/22W	3640lm/29W	5160lm/43W	1765	3000lm/29W	4250lm/43W
2004	5000lm/35W	7180lm/53W	2055	2860lm/27W	3870lm/36W	5490lm/52W	2055	3140lm/27W	4250lm/36W	6020lm/52W	2055	3500lm/36W	4960lm/52W

Lumen Values: Luminaire luminous flux at 4000K/CRI>80. Other configurations on request.

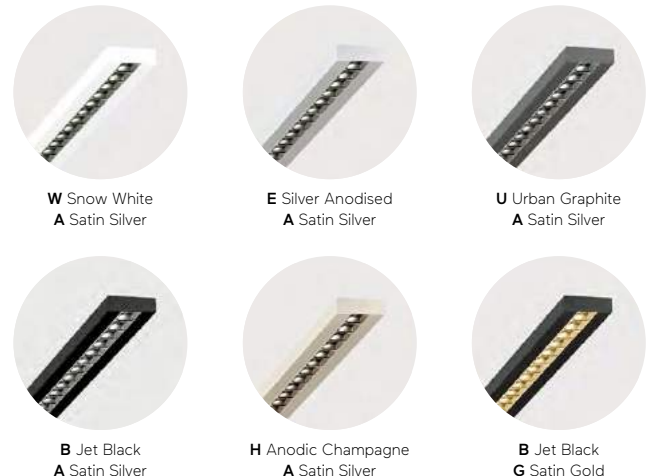
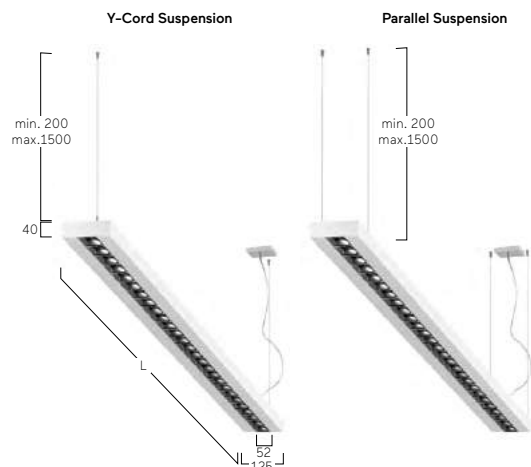

Plank G4/P4 | Suspended



DE LED-Pendelleuchte. Direkt-indirekt oder rein direktstrahlend. Leuchtenkörper aus Aluminiumprofil mit 25mm Bauhöhe. Oberfläche naturel oxidiert oder weiß, graphit, schwarz, champagner oder kupferfarben lackiert. Weitere Oberflächenoptionen siehe Lightnet-Surface-Collection oder RAL nach Wahl. Microprismenoptik aus Spezialacrylglas mit optimierter Blendungsbegrenzung für Office-Anwendungen. Satiniertes Opaldiffusor für Allgemeinbeleuchtung mit max. Transmissionsgrad und homogener Lichtpunktauflösung. Konverter in Leuchtgehäuse integriert, wahlweise einfach schaltbar oder stufenlos dimmbar (DALI, Touch-Dim, Casambi). Farbtemperatur 2200K, 2700K, 3000K, 3500K, 4000K, 6500K oder Tunable White (2700-6500K). Binning initial \leq MacAdam 3. Farbwiedergabe CRI $>$ 80, CRI $>$ 90 oder Full Spectrum. Stufenlos höhenverstellbare Y- oder Parallel-Seilabhängung mit transparent ummantelter Zuleitung. Lackierung Baldachin passend Leuchtenkörper.

EN LED pendant luminaire. Direct-indirect or direct-only light distribution. Luminaire body made of 25mm high aluminium profile. Surface natural anodised or white, graphite, black, champagne or copper coated. Further surface options see Lightnet-Surface-Collection or RAL of your choice. Microprismatic screen made of special acrylic glass with optimized glare reduction especially for workplaces. Satin opal diffuser for general lighting with maximum transmittance and homogeneous lighting. Driver integrated into luminaire housing, optionally switchable or dimmable (DALI, Touch-Dim, Casambi). Colour temperature 2200K, 2700K, 3000K, 3500K, 4000K, 6500K or Tunable White (2700-6500K). Binning \leq MacAdam 3. Colour rendering CRI $>$ 80, CRI $>$ 90 or Full Spectrum. Height-adjustable Y- or parallel cord suspension with transparent power supply cable. Colours ceiling rose match to luminaire body.

JP4 A W E-8 30 M-L1210-K

Product Family	J: Plank
Type	G4: Direct only, P4: Direct-Indirect
Optical System	A: Microprismatic, O: Opal Diffuser
Surface Finish	W: Snow White, E: Silver Anodised, U: Urban Graphite, B: Jet Black, H: Anodic Champagne, K: Satin Copper
Control Gear	E: On/Off, L: DALI, H: Touch-Dim, C: Casambi, 6: DALI DT6 for TW, 8: DALI DT8 for TW
Colour Rendering	8: CRI>80, 9: CRI>90, F: Full Spectrum [except 2200K]
Colour Temperature	22: 2200K, 27: 2700K, 30: 3000K, 35: 3500K, 40: 4000K, 65: 6500K, TW: Tunable White 2700-6500K
Power	M: Medium Power, H: High Power
Size	Luminaire length in mm: L920, L1210, L1500, L1800
Suspension	K: Parallel Suspension, Y: Y-Cord Suspension



Microprismatic | Direct-Indirect

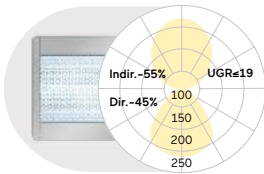

Microprismatic | Direct

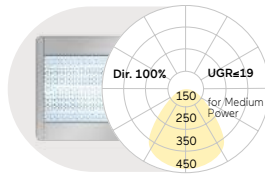

Opal Diffuser | Direct-Indirect

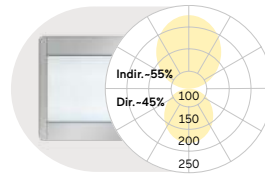

Opal Diffuser | Direct

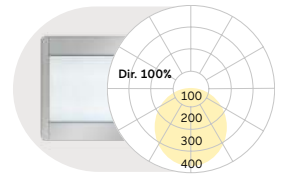

L mm	Lumen/Watt		L mm	Lumen/Watt		L mm	Lumen/Watt		L mm	Lumen/Watt	
	Medium Power	High Power		Medium Power	High Power		Medium Power	High Power		Medium Power	High Power
920	2840lm/24W	4530lm/38W	920	1340lm/13W	2130lm/21W	920	2750lm/24W	4380lm/38W	920	1250lm/13W	1980lm/21W
1210	3790lm/33W	6030lm/53W	1210	1790lm/17W	2840lm/27W	1210	3670lm/33W	5830lm/53W	1210	1670lm/17W	2640lm/27W
1500	4740lm/40W	7540lm/64W	1500	2240lm/20W	3550lm/33W	1500	4580lm/40W	7290lm/64W	1500	2080lm/20W	3300lm/33W
1800	5690lm/47W	9050lm/76W	1800	2690lm/24W	4260lm/39W	1800	5500lm/47W	8750lm/76W	1800	2500lm/24W	3960lm/39W

Lumen Values: Luminaire luminous flux at 4000K/CRI>80. Other configurations on request.

Y-Cord Suspension



Parallel Suspension



W Snow White



E Silver Anodised



U Urban Graphite



B Jet Black



H Anodic Champagne



K Satin Copper



Midpoint B7 |
Surface
334

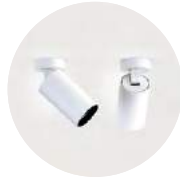

Midpoint A6 |
Surface
336



Basic Superflat Y7/X7 |
Surface
338



Basic Neo A5 |
Surface
342



Basic Neo X5 |
Surface
344



Basic Déco A3/A4 |
Surface
346



Basic Déco X3 |
Surface
348



Basic Déco Z3 |
Surface
350



Basic Max A1 |
Surface
352



Basic Max Y1/X1 |
Surface
354



Basic Visio Y9/X9 |
Surface
356



Beam Me Up (Flat)
Y3/X3 | Surface
358



Beam Me Up (Max)
Y1/X1 | Surface
362



Beam Me Up (Wallwasher)
A4 | Surface
364



Ringo Star Compact A5 |
Surface
366



Ringo Star AX | System
40mm Surface
368



Ringo Star A3 | System
60mm Surface
370



Ringo Star A1 | System
100mm Surface
372



Liquid Line Compact
A5 | Surface
374



Liquid Line AX | System
40mm Surface
376



Liquid Line A3 | System
60mm Surface
382



Caleo Inverse AX |
System 40mm Surface
386



Caleo Neo Y4/X4 |
200mm Surface
388



Caleo Neo Y6/X6 |
Square Surface
390



Cubic Evolution Y4/X4 |
200mm Surface
392



Cubic Evolution Y5/X5 |
300mm Surface
394



Cubic Evolution Y6/X6 |
Square Surface
396



Cubic Neo A9 |
Surface
398



Cubic Max A2/X2 |
Surface
400



Cubic Ambient A7 |
Surface
402



Cubic Déco A3 |
Surface
404



Matric Déco A9 |
Surface
406



Matric AY | System
40mm Surface
408

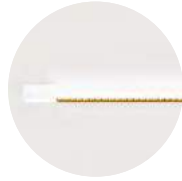

Matric XY | System
40mm Surface
410



Matric AX | System
40mm Surface
418



Matric A3 | System
55mm Surface
420

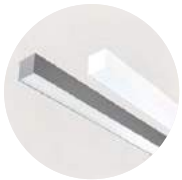

Matric A5 | System
81mm Surface
422

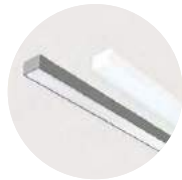

Matric A6 | System
81mm Surface
424



Vision Gen. 4 A4/X4 |
Surface
426



Plank Y4/X4 |
Surface
428

Anbau | Surface

Midpoint B7 | Surface



DE LED-Strahler für Anbaumontage. Direktstrahlend. Konverter in Leuchtenkörper integriert, wahlweise einfach schaltbar oder stufenlos dimmbar (DALI). Gehäuse aus Aluminium in weiß, silber, schwarz oder champagnerfarben lackiert. Weitere Oberflächenoptionen siehe Lightnet Surface Collection oder RAL nach Wahl. LED Engine wahlweise XICATO ARTIST für höchste Lichtqualität mit bester Farbwiedergabe (CRI>97) und 5 Jahre Garantie für Farbkonzanz (MacAdam \leq 3) oder ECO für höchste Energieeffizienz bei optimalem Preis-Leistungsverhältnis und CRI>90. Farbtemperaturen 2700K, 3000K oder 4000K. Austauschbare Linsen-Reflektoroptiken mit sphärischer Facettenoptik. Ausstrahlwinkel: 10° (Spot), 20° (Medium), 35° (Flood) oder 50° (Wide Flood). Reflektoring in verschiedenen Farbausführungen erhältlich. Standardmäßig klare Abdeckung. Optional zusätzliche Filter oder Wabenraster.

EN LED surface-mounted spotlight. Direct only light distribution. Driver integrated into luminaire body, optionally switchable or dimmable (DALI). Housing made of white, silver, black or champagne coated aluminum. Further surface options see Lightnet-Surface-Collection or RAL of your choice. LED Engine with XICATO ARTIST for highest light quality and colour rendering (CRI>97), including 5-year warranty for colour consistency (MacAdams 3) or ECO for highest energy efficiency with optimal price performance ratio and CRI> 90. Colour temperature 2700K, 3000K or 4000K. Replaceable lens reflector optic with spherical faceted optic. Beam angle: 10° (Spot), 20° (Medium), 35° (Flood) or 50° (Wide Flood). Reflector ring available in different colour versions. Standard clear cover. Optional additional filters or honeycomb louvre.

PB7BSE-927FM-BK

- Product Family **P**: Midpoint
- Type **B7**: Direct only
- Beam Angle **A**: Spot 10°, **B**: Medium 20°, **C**: Flood 35°, **D**: Wide Flood 50°
- Surface Finish **W**: Snow White, **V**: Ivory White, **S**: Radiant Silver, **B**: Jet Black, **H**: Anodic Champagne
- Control Gear **E**: On/Off, **L**: DALI, **H**: Touch-Dim
- Colour Rendering **9**: CRI>90
- Colour Temperature **27**: 2700K, **30**: 3000K, **40**: 4000K
- Led-Engine **F**: Eco [Ra> 90], **A**: Artist [Ra> 97, Xicato]
- Power **E**: Low Power **M**: Medium Power
- Optic Ring **W**: Snow White, **V**: Ivory White, **S**: Radiant Silver, **B**: Jet Black, **H**: Anodic Champagne, **G**: Satin Gold, **K**: Satin Copper
- Cover **K**: Clear Cover [Standard], **P**: Prismatic Lens, **H**: Honeycomb Louvre
- On Request Optic Removal Tool for clear cover



Spot 10° Led Engine Eco, Medium Power

Mounting Height	Illuminance[Lux] center/side	Beam Diameter
1 m	25250/12700	0.24 m
2 m	6312/3175	0.48 m
3 m	2806/1411	0.72 m
4 m	1578/794	0.95 m

LED Engine	2700K	3000K	4000K
Eco Low			
Power [19W]	1230 lm	1350 lm	1440 lm
Eco Medium			
Power [31W]	1660 lm	1860 lm	2020 lm
Artist Low			
Power [19W]	1040 lm	1090 lm	1190 lm
Artist Medium			
Power [31W]	1400 lm	1480 lm	1560 lm

Medium 20° Led Engine Eco, Medium Power

Mounting Height	Illuminance[Lux] center/side	Beam Diameter
1 m	17447/8455	0.32 m
2 m	4362/2114	0.64 m
3 m	1939/939	0.96 m
4 m	1090/528	1.30 m

LED Engine	2700K	3000K	4000K
Eco Low			
Power [19W]	1580 lm	1740 lm	1850 lm
Eco Medium			
Power [31W]	2360 lm	2640 lm	2870 lm
Artist Low			
Power [19W]	1330 lm	1390 lm	1510 lm
Artist Medium			
Power [31W]	1980 lm	2110 lm	2220 lm

Flood 35° Led Engine Eco, Medium Power

Mounting Height	Illuminance[Lux] center/side	Beam Diameter
1 m	6251/2731	0.63 m
2 m	1563/683	1.30 m
3 m	695/303	1.90 m
4 m	391/171	2.50 m

LED Engine	2700K	3000K	4000K
Eco Low			
Power [19W]	1530 lm	1680 lm	1790 lm
Eco Medium			
Power [31W]	2280 lm	2550 lm	2780 lm
Artist Low			
Power [19W]	1290 lm	1350 lm	1470 lm
Artist Medium			
Power [31W]	1930 lm	2060 lm	2160 lm

Wide Flood 50° Led Engine Eco, Medium Power

Mounting Height	Illuminance[Lux] center/side	Beam Diameter
1 m	3550/1319	0.94 m
2 m	887/330	1.90 m
3 m	394/147	2.80 m
4 m	222/82	3.80 m

LED Engine	2700K	3000K	4000K
Eco Low			
Power [19W]	1440 lm	1580 lm	1680 lm
Eco Medium			
Power [31W]	2230 lm	2490 lm	2710 lm
Artist Low			
Power [19W]	1250 lm	1310 lm	1430 lm
Artist Medium			
Power [31W]	1910 lm	2040 lm	2140 lm



Midpoint A6 | Surface



DE LED-Strahler für Anbaumontage. 350° drehbar und 90° schwenkbar. Konverter in Leuchtenkörper integriert, wahlweise einfach schaltbar oder stufenlos dimmbar (DALI). Gehäuse aus Aluminium in weiß, silber, schwarz oder champagnerfarben lackiert. Weitere Oberflächenoptionen siehe Lightnet Surface Collection oder RAL nach Wahl. LED Engine wahlweise XICATO ARTIST für höchste Lichtqualität mit bester Farbwiedergabe (CRI>97) und 5 Jahre Garantie für Farbkonstanz (MacAdam \leq 3) oder ECO für höchste Energieeffizienz bei optimalem Preis-Leistungsverhältnis und CRI>90. Farbtemperaturen 2700K, 3000K oder 4000K. Austauschbare Linsen-Reflektoroptiken mit sphärischer Facettenoptik. Ausstrahlwinkel: 10° (Spot), 20° (Medium), 35° (Flood) oder 50° (Wide Flood). Reflektorring in verschiedenen Farbausführungen erhältlich. Standardmäßig klare Abdeckung. Optional zusätzliche Filter oder Wabenraster.

EN LED surface-mounted adjustable spotlight. 350° rotation and 90° tilt. Driver integrated into luminaire body, optionally switchable or dimmable (DALI). Housing made of white, silver, black or champagne coated aluminum. Further surface options see Lightnet-Surface-Collection or RAL of your choice. LED Engine with XICATO ARTIST for highest light quality and colour rendering (CRI>97), including 5-year warranty for colour consistency (MacAdams 3) or ECO for highest energy efficiency with optimal price-performance ratio and CRI> 90. Colour temperature 2700K, 3000K or 4000K. Replaceable lens reflector optic with spherical faceted optic. Beam angle: 10° (Spot), 20° (Medium), 35° (Flood) or 50° (Wide Flood). Decorative trim available in different colour versions. Standard clear cover. Optional additional filters or honeycomb louvre.

PA6BSE-927FM-BK

Product Family	P: Midpoint
Type	A6: Direct only
Beam Angle	A: Spot 10°, B: Medium 20°, C: Flood 35°, D: Wide Flood 50°
Surface Finish	W: Snow White, V: Ivory White, S: Radiant Silver, B: Jet Black, H: Anodic Champagne
Control Gear	E: On/Off, L: DALI, H: Touch-Dim
Colour Rendering	9: CRI>90
Colour Temperature	27: 2700K, 30: 3000K, 40: 4000K
Led-Engine	F: Eco [Ra> 90], A: Artist [Ra> 97, Xicato]
Power	E: Low Power M: Medium Power
Optic Ring	W: Snow White, V: Ivory White, S: Radiant Silver, B: Jet Black, H: Anodic Champagne, G: Satin Gold, K: Satin Copper
Cover	K: Clear Cover [Standard], P: Prismatic Lens, H: Honeycomb Louvre
On Request	Optic Removal Tool for clear cover



Spot 10° Led Engine Eco, Medium Power

Mounting Height	Illuminance[Lux] center/side	Beam Diameter
1 m	25250/12700	0.24 m
2 m	6312/3175	0.48 m
3 m	2806/1411	0.72 m
4 m	1578/794	0.95 m

LED Engine	2700K	3000K	4000K
Eco Low Power [19W]	1230 lm	1350 lm	1440 lm
Eco Medium Power [31W]	1660 lm	1860 lm	2020 lm
Artist Low Power [19W]	1040 lm	1090 lm	1190 lm
Artist Medium Power [31W]	1400 lm	1480 lm	1560 lm

Medium 20° Led Engine Eco, Medium Power

Mounting Height	Illuminance[Lux] center/side	Beam Diameter
1 m	17447/8455	0.32 m
2 m	4362/2114	0.64 m
3 m	1939/939	0.96 m
4 m	1090/528	1.30 m

LED Engine	2700K	3000K	4000K
Eco Low Power [19W]	1580 lm	1740 lm	1850 lm
Eco Medium Power [31W]	2360 lm	2640 lm	2870 lm
Artist Low Power [19W]	1330 lm	1390 lm	1510 lm
Artist Medium Power [31W]	1980 lm	2110 lm	2220 lm

Flood 35° Led Engine Eco, Medium Power

Mounting Height	Illuminance[Lux] center/side	Beam Diameter
1 m	6251/2731	0.63 m
2 m	1563/683	1.30 m
3 m	695/303	1.90 m
4 m	391/171	2.50 m

LED Engine	2700K	3000K	4000K
Eco Low Power [19W]	1530 lm	1680 lm	1790 lm
Eco Medium Power [31W]	2280 lm	2550 lm	2780 lm
Artist Low Power [19W]	1290 lm	1350 lm	1470 lm
Artist Medium Power [31W]	1930 lm	2060 lm	2160 lm

Wide Flood 50° Led Engine Eco, Medium Power

Mounting Height	Illuminance[Lux] center/side	Beam Diameter
1 m	3550/1319	0.94 m
2 m	887/330	1.90 m
3 m	394/147	2.80 m
4 m	222/82	3.80 m

LED Engine	2700K	3000K	4000K
Eco Low Power [19W]	1440 lm	1580 lm	1680 lm
Eco Medium Power [31W]	2230 lm	2490 lm	2710 lm
Artist Low Power [19W]	1250 lm	1310 lm	1430 lm
Artist Medium Power [31W]	1910 lm	2040 lm	2140 lm

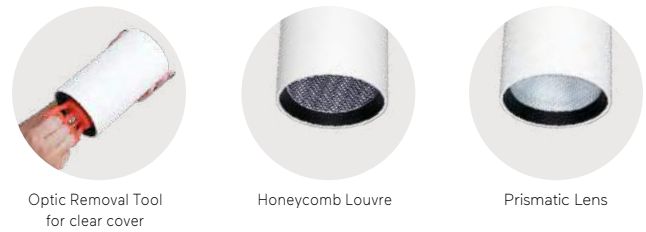

Basic Superflat Y7/X7 | Surface



DE LED-Anbauleuchte für Wand- oder Deckenmontage. Direktstrahlend mit indirekter Lichtkorona oder rein direktstrahlend. Gestuftes Leuchtenkörper aus Aluminiumprofil mit lediglich 18mm sichtbarem Rahmenprofil. Oberfläche weiß, silber, graphit, schwarz, champagner oder kupferfarben lackiert. Weitere Oberflächenoptionen siehe Lightnet-Surface-Collection oder RAL nach Wahl. Microprismenoptik mit optimierter Blendungsbegrenzung speziell für Office-Anwendungen. Satinierter Opaldiffusor für Allgemeinbeleuchtung mit max. Transmissionsgrad und homogener Lichtpunktauflösung. Konverter in Leuchtengehäuse integriert, wahlweise einfach schaltbar oder stufenlos dimmbar (DALI, Touch-Dim, Casambi). Farbtemperatur 2200K, 2700K, 3000K, 3500K, 4000K, 6500K oder Tunable White (2700-6500K). Binning initial \leq MacAdam 3. Farbwiedergabe CRI $>$ 80, CRI $>$ 90 oder Full Spectrum. Auf Anfrage: Integration von Notlichtkomponenten, Sensortechnologie.

EN LED surface-mounted luminaire for walls or ceilings. Direct light distribution and indirect lighting corona or direct only light distribution. Tiered luminaire body made of aluminium profile with 18mm visible trim. Surface white, silver, graphite, black, champagne or copper coated. Further surface options see Lightnet-Surface-Collection or RAL of your choice. Microprismatic screen with optimized glare reduction especially for workplaces. Satin opal diffuser for general lighting with maximum transmittance and homogeneous lighting. Driver integrated into luminaire housing, optionally switchable or dimmable (DALI, Touch-Dim, Casambi). Colour temperature 2200K, 2700K, 3000K, 3500K, 4000K, 6500K or Tunable White (2700-6500K). Binning \leq MacAdam 3. Colour rendering CRI $>$ 80, CRI $>$ 90 or Full Spectrum. On request: Integration of emergency lighting components, sensor technology.

B X7 A S L - 8 30 M-D300

- Product Family **B: Basic**
- Type **X7: Direct-Indirect, Y7: Direct only**
- Optical System **A: Microprismatic, O: Opal Diffuser**
- Surface Finish **W: Snow White, V: Ivory White, S: Radiant Silver, U: Urban Graphite, B: Jet Black, H: Anodic Champagne, K: Satin Copper**
- Control Gear **E: On/Off, L: DALI, H: Touch-Dim, C: Casambi, 6: DALI DT6 for TW, 8: DALI DT8 for TW**
- Colour Rendering **8: CRI>80, 9: CRI>90, F: Full Spectrum [except 2200K]**
- Colour Temperature **22: 2200K, 27: 2700K, 30: 3000K, 35: 3500K, 40: 4000K, 65: 6500K, TW: Tunable White 2700-6500K [D400-D800]**
- Power **M: Medium Power, H: High Power**
- Size Luminaire Diameter in mm: **D300, D400, D500, D600, D800**
- On Request Emergency Module [D400-D800], Multisensor [D400-D800], Radar Sensor

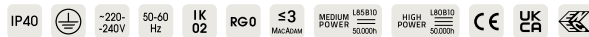

Microprismatic | Direct-Indirect

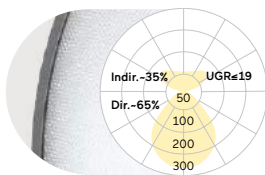

D mm	Lumen/Watt Medium Power	Lumen/Watt High Power
300	1260lm/11W	2150lm/18W
400	2330lm/18W	4050lm/31W
500	3000lm/23W	5240lm/40W
600	5380lm/40W	8270lm/63W
800	7860lm/60W	10750lm/81W

Microprismatic | Direct

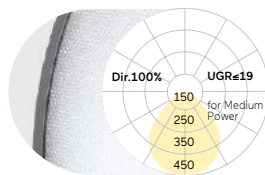

D mm	Lumen/Watt Medium Power	Lumen/Watt High Power
300	690lm/7W	1190lm/11W
400	1470lm/12W	2560lm/21W
500	2030lm/16W	3570lm/28W
600	3390lm/25W	5520lm/42W
800	5160lm/40W	6980lm/54W

Opal Diffuser | Direct-Indirect

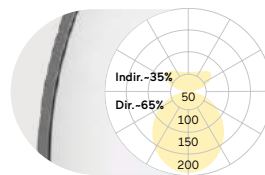

D mm	Lumen/Watt Medium Power	Lumen/Watt High Power
300	1270lm/11W	2160lm/18W
400	2350lm/18W	4070lm/31W
500	3040lm/23W	5300lm/40W
600	5450lm/40W	8370lm/63W
800	7980lm/60W	10920lm/81W

Opal Diffuser | Direct

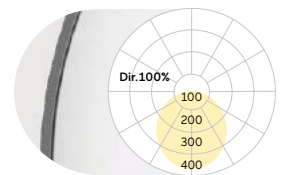

D mm	Lumen/Watt Medium Power	Lumen/Watt High Power
300	700lm/7W	1200lm/11W
400	1490lm/12W	2580lm/21W
500	2070lm/16W	3630lm/28W
600	3460lm/25W	5620lm/42W
800	5280lm/40W	7150lm/54W

Lumen Values: Luminaire luminous flux at 4000K/CRI>80. Other configurations on request.

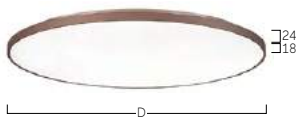

Multisensor



Emergency Module



W Snow White



S Radiant Silver



U Urban Graphite



B Jet Black



H Anodic Champagne



K Satin Copper

Basic Surface



Ziegler, Ploebberg, Germany
Basic A1





Freight forwarding Schmidt
Heilbronn, Germany
Basic Z3, Basic L7

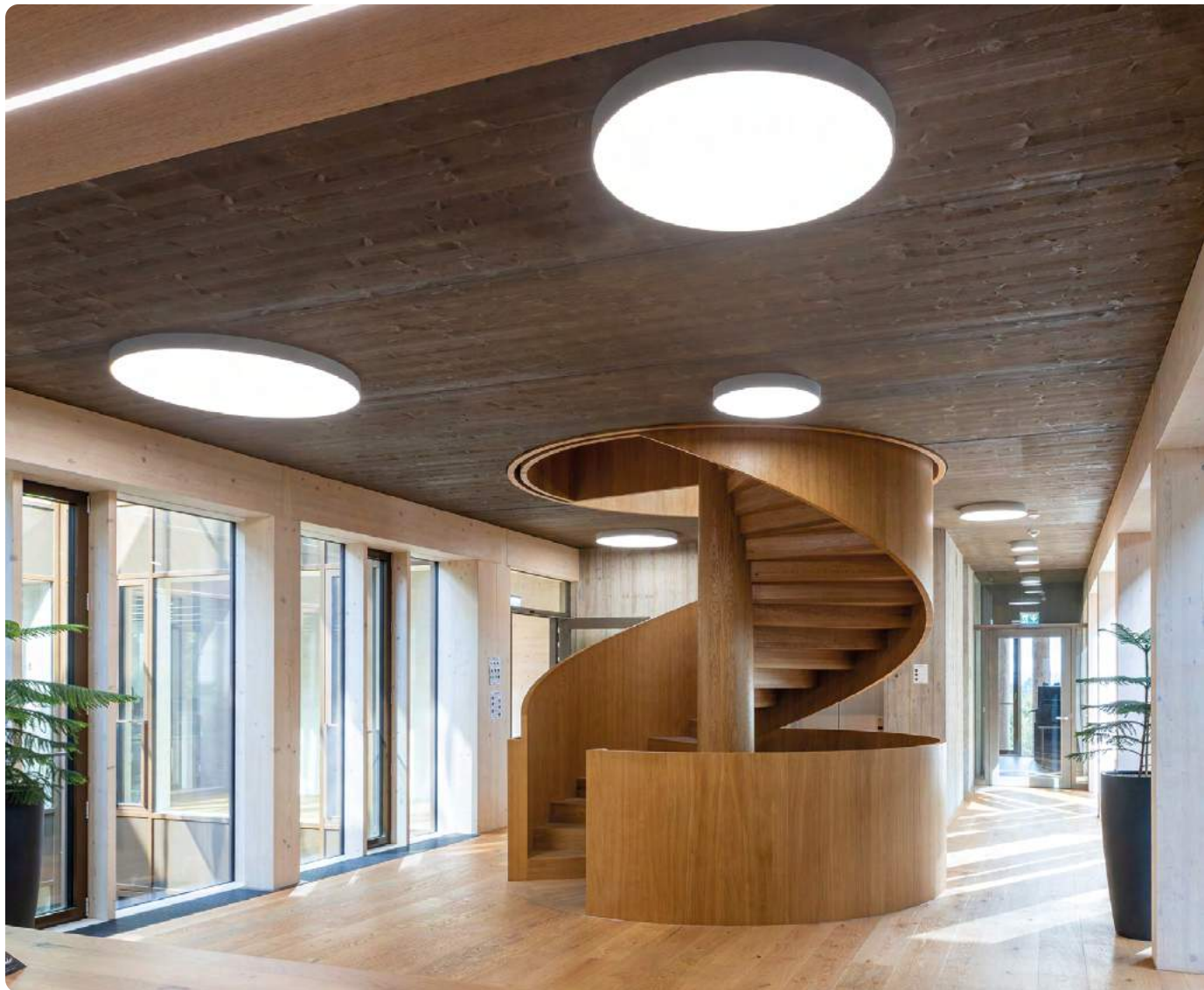

Basic Neo A5 | Surface



DE LED-Anbauleuchte für Wand- oder Deckenmontage. Rein direktstrahlend. Oberfläche weiß, silber, graphit, schwarz, champagner oder kupferfarben lackiert. Weitere Oberflächenoptionen siehe Lightnet-Surface-Collection oder RAL nach Wahl. Microprismenoptik mit optimierter Blendungsbegrenzung speziell für Office-Anwendungen. Satinierter Opaldiffusor für Allgemeinbeleuchtung mit max. Transmissionsgrad und homogener Lichtpunktauflösung. Konverter in Leuchtgehäuse integriert, wahlweise einfach schaltbar oder stufenlos dimmbar (DALI, Touch-Dim, Casambi). Farbtemperatur 2200K, 2700K, 3000K, 3500K, 4000K, 6500K oder Tunable White (2700-6500K). Binning initial \leq MacAdam 3. Farbwiedergabe CRI > 80, CRI > 90 oder Full Spectrum. Auf Anfrage: Integration von Notlichtkomponenten, Sensortechnologie.

EN LED surface-mounted luminaire for walls or ceilings. Direct only light distribution. Surface white, silver, graphite, black, champagne or copper coated. Further surface options see Lightnet-Surface-Collection or RAL of your choice. Microprismatic screen with optimized glare reduction especially for workplaces. Satin opal diffuser for general lighting with maximum transmittance and homogeneous lighting. Driver integrated into luminaire housing, optionally switchable or dimmable (DALI, Touch-Dim, Casambi). Colour temperature 2200K, 2700K, 3000K, 3500K, 4000K, 6500K or Tunable White (2700-6500K). Binning \leq MacAdam 3. Colour rendering CRI > 80, CRI > 90 or Full Spectrum. On request: Integration of emergency lighting components, sensor technology.

B A5 O S L - 8 30 M-D400

- Product Family **B:** Basic
- Type **A5:** Direct Only
- Optical System **A:** Microprismatic, **O:** Opal Diffuser
- Surface Finish **W:** Snow White, **V:** Ivory White, **S:** Radiant Silver, **U:** Urban Graphite, **B:** Jet Black, **H:** Anodic Champagne, **K:** Satin Copper
- Control Gear **E:** On/Off, **L:** DALI, **H:** Touch-Dim, **C:** Casambi, **6:** DALI DT6 for TW, **8:** DALI DT8 for TW
- Colour Rendering **8:** CRI>80, **9:** CRI>90, **F:** Full Spectrum [except 2200K]
- Colour Temperature **22:** 2200K, **27:** 2700K, **30:** 3000K, **35:** 3500K, **40:** 4000K, **65:** 6500K, **TW:** Tunable White 2700-6500K [D400-D800]
- Power **M:** Medium Power, **H:** High Power
- Size Luminaire Diameter in mm: **D300, D400, D500, D600, D800**
- On Request Multisensor [D400-D800], Radar Sensor, Emergency Module [D400-D800]



Microprismatic | Direct

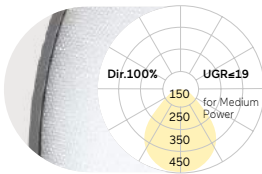

Opal Diffuser | Direct

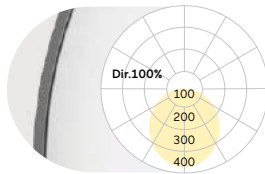

D mm	Lumen/Watt		D mm	Lumen/Watt	
	Medium Power	High Power		Medium Power	High Power
300	690lm/7W	1190lm/11W	300	700lm/7W	1200lm/11W
400	1470lm/12W	2560lm/21W	400	1490lm/12W	2580lm/21W
500	2030lm/16W	3570lm/28W	500	2070lm/16W	3630lm/28W
600	3390lm/25W	5520lm/42W	600	3460lm/25W	5620lm/42W
800	5160lm/40W	6980lm/54W	800	5280lm/40W	7150lm/54W

Lumen Values: Luminaire luminous flux at 4000K/CRI>80. Other configurations on request.



Multisensor



Emergency Module



W Snow White



S Radiant Silver



U Urban Graphite



B Jet Black



H Anodic Champagne



K Satin Copper

Basic Neo X5 | Surface



DE LED-Anbauleuchte für Wand- oder Deckenmontage. Direktstrahlend mit indirekter Lichtkorona. Oberfläche weiß, silber, graphit, schwarz, champagner oder kupferfarben lackiert. Weitere Oberflächenoptionen siehe Lightnet-Surface-Collection oder RAL nach Wahl. Microprismenoptik mit optimierter Blendungsbegrenzung speziell für Office-Anwendungen. Satinierter Opaldiffusor für Allgemeinbeleuchtung mit max. Transmissionsgrad und homogener Lichtpunktauflösung. Konverter in Leuchtgehäuse integriert, wahlweise einfach schaltbar oder stufenlos dimmbar (DALI, Touch-Dim, Casambi). Farbtemperatur 2200K, 2700K, 3000K, 3500K, 4000K, 6500K oder Tunable White (2700-6500K). Binning initial \leq MacAdam 3. Farbwiedergabe CRI > 80, CRI > 90 oder Full Spectrum. Auf Anfrage: Integration von Notlichtkomponenten, Sensortechnologie.

EN LED surface-mounted luminaire for walls or ceilings. Direct light distribution and indirect lighting corona. Surface white, silver, graphite, black, champagne or copper coated. For further surface options see Lightnet-Surface-Collection or RAL of your choice. Microprismatic screen with optimized glare reduction especially for workplaces. Satin opal diffuser for general lighting with maximum transmittance and homogeneous lighting. Driver integrated into luminaire housing, optionally switchable or dimmable (DALI, Touch-Dim, Casambi). Colour temperature 2200K, 2700K, 3000K, 3500K, 4000K, 6500K or Tunable White (2700-6500K). Binning \leq MacAdam 3. Colour rendering CRI > 80, CRI > 90 or Full Spectrum. On request: Integration of emergency lighting components, sensor technology.

B X5 O S L - 8 30 M-D400

- Product Family **B:** Basic
- Type **X5:** Direct-Indirect
- Optical System **A:** Microprismatic, **O:** Opal Diffuser
- Surface Finish **W:** Snow White, **V:** Ivory White, **S:** Radiant Silver, **U:** Urban Graphite, **B:** Jet Black, **H:** Anodic Champagne, **K:** Satin Copper
- Control Gear **E:** On/Off, **L:** DALI, **H:** Touch-Dim, **C:** Casambi [D400-D800], **6:** DALI DT6 for TW, **8:** DALI DT8 for TW
- Colour Rendering **8:** CRI>80, **9:** CRI>90, **F:** Full Spectrum [except 2200K]
- Colour Temperature **22:** 2200K, **27:** 2700K, **30:** 3000K, **35:** 3500K, **40:** 4000K, **65:** 6500K, **TW:** Tunable White 2700-6500K [D400-D800]
- Power **M:** Medium Power, **H:** High Power
- Size Luminaire Diameter in mm: **D300, D400, D500, D600, D800**
- On Request Multisensor [D400-D800], Radar Sensor, Emergency Module [D400-D800]



Microprismatic | Direct-Indirect

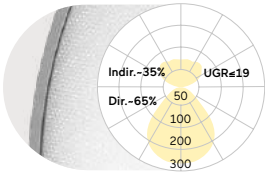

Opal Diffuser | Direct-Indirect

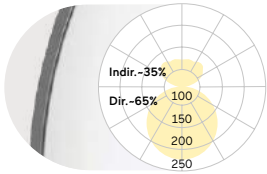

D mm	Lumen/Watt		D mm	Lumen/Watt	
	Medium Power	High Power		Medium Power	High Power
300	1210lm/11W	2070lm/18W	300	1220lm/11W	2080lm/18W
400	2260lm/18W	3920lm/31W	400	2280lm/18W	3940lm/31W
500	2920lm/23W	5100lm/40W	500	2960lm/23W	5160lm/40W
600	5210lm/40W	8040lm/63W	600	5280lm/40W	8140lm/63W
800	7630lm/60W	10430lm/81W	800	7750lm/60W	10600lm/81W

Lumen Values: Luminaire luminous flux at 4000K/CRI>80. Other configurations on request.

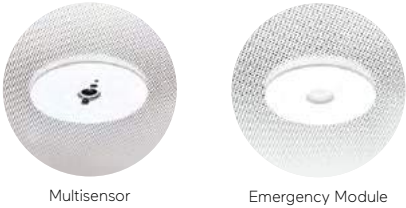

Basic Déco A3/A4 | Surface



DE LED-Anbauleuchte für Wand- und Deckenmontage. Rein direktstrahlend. Leuchtenkörper aus Aluminiumprofil. Gehäuse-Außenfläche und Innendekor in unterschiedlichen Lackierungen und Kombinationen erhältlich, z.B. weiß, silber, graphit, schwarz, gold oder kupferfarben. Zu Oberflächenoptionen- und Kombinationen siehe Lightnet-Surface-Collection oder Bi-Colour-Auswahl. Rückversetzte Microprismenoptik mit optimierter Blendungsbegrenzung speziell für Office-Anwendungen. Satinierter Opaldiffusor für Allgemeinbeleuchtung mit max. Transmissionsgrad und homogener Lichtpunktauflösung. Konverter in Leuchtgehäuse integriert, wahlweise einfach schaltbar oder stufenlos dimmbar (DALI, Touch-Dim, Casambi). Farbtemperatur 2200K, 2700K, 3000K, 3500K, 4000K, 6500K oder Tunable White (2700-6500K). Binning initial \leq MacAdam 3. Farbwiedergabe CRI > 80, CRI > 90 oder Full Spectrum. Auf Anfrage: Integration von Notlichtkomponenten.

EN LED surface-mounted luminaire for walls and ceilings. Direct only light distribution. Luminaire body made of aluminum profile. Outer housing and inner decor available in various finishes and combinations, e.g. white, silver, graphite, black, gold or copper coated. For further surface options see Lightnet-Surface-Collection or RAL of your choice. Recessed microprismatic screen with optimized glare reduction especially for workplaces. Satin opal diffuser for general lighting with maximum transmittance and homogeneous lighting. Driver integrated into luminaire housing, optionally switchable or dimmable (DALI, Touch-Dim, Casambi). Colour temperature 2200K, 2700K, 3000K, 3500K, 4000K, 6500K or Tunable White (2700-6500K). Binning \leq MacAdam 3. Colour rendering CRI > 80, CRI > 90 or Full Spectrum. On request: Integration of emergency lighting components.

B A3 A SL-8 30 M-D500-G

- Product Family **B: Basic**
- Type **A3: Direct only, A4: Direct only**
- Optical System **A: Microprismatic, O: Opal Diffuser**
- Surface Finish **W: Snow White, V: Ivory White, S: Radiant Silver, U: Urban Graphite, B: Jet Black, H: Anodic Champagne, K: Satin Copper**
- Control Gear **E: On/Off, L: DALI, H: Touch-Dim, C: Casambi, 6: DALI DT6 for TW, 8: DALI DT8 for TW**
- Colour Rendering **8: CRI>80, 9: CRI>90, F: Full Spectrum [except 2200K]**
- Colour Temperature **22: 2200K, 27: 2700K, 30: 3000K, 35: 3500K, 40: 4000K, 65: 6500K, TW: Tunable White 2700-6500K [D400-D1200]**
- Power **E: Low Power, M: Medium Power, H: High Power**
- Size Luminaire Diameter in mm: **D300, D400, D500, D600, D800 [A3 only], D900 [A4 only], D1200 [A4 only]**
- Reflector **W: Snow White, V: Ivory White, S: Radiant Silver, U: Urban Graphite, B: Jet Black, H: Anodic Champagne, K: Satin Copper, G: Satin Gold**
- On Request Multisensor [D400-D800], Radar Sensor, Emergency Module [D400-D1200]



A3 Microprismatic | Direct

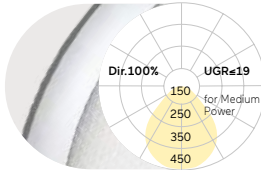

D mm	Lumen/Watt Medium Power	Lumen/Watt High Power
300	830lm/8W	1430lm/13W
400	1500lm/14W	2410lm/21W
500	2370lm/21W	3980lm/35W
600	3560lm/28W	5230lm/42W
800	5360lm/44W	6490lm/55W

A3 Opal Diffuser | Direct

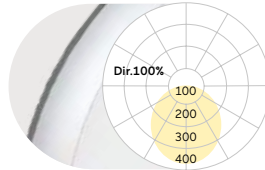

D mm	Lumen/Watt Medium Power	Lumen/Watt High Power
300	810lm/8W	1400lm/13W
400	1500lm/14W	2410lm/21W
500	2390lm/21W	4040lm/35W
600	3650lm/28W	5330lm/42W
800	5510lm/44W	6660lm/55W

A4 Microprismatic | Direct

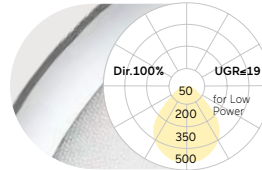

D mm	Lumen/Watt Low Power	Lumen/Watt Medium Power
300	880lm/8W	1730lm/14W
400	1740lm/13W	3580lm/29W
500	2480lm/18W	4860lm/35W
600	3860lm/28W	7250lm/52W
900	6800lm/59W	11490lm/106W
1200	11890lm/107W	20110lm/195W

A4 Opal Diffuser | Direct

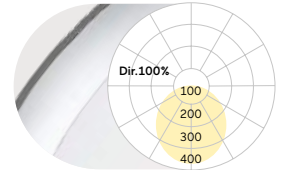

D mm	Lumen/Watt Low Power	Lumen/Watt Medium Power
300	910lm/8W	1780lm/14W
400	1790lm/13W	3690lm/29W
500	2550lm/18W	5010lm/35W
600	3980lm/28W	7470lm/52W
900	7000lm/59W	11830lm/106W
1200	12250lm/107W	20700lm/195W

Lumen Values: Luminaire luminous flux at 4000K/CRI>80. Other configurations on request.



Multisensor



Emergency Module



W Snow White
W Snow White



S Radiant Silver
S Radiant Silver



U Urban Graphite
U Urban Graphite



B Jet Black
B Jet Black



H Anodic Champagne
H Anodic Champagne



K Satin Copper
K Satin Copper



W Snow White
B Jet Black



W Snow White
K Satin Copper



W Snow White
G Satin Gold



B Jet Black
W Snow White



H Anodic Champagne
B Jet Black



B Jet Black
G Satin Gold

Basic Déco X3 | Surface



DE LED-Anbauleuchte für Wand- und Deckenmontage. Direktstrahlend mit indirekter Lichtkorona. Leuchtenkörper aus Aluminiumprofil. Gehäuse-Außenfläche und Innendekor in unterschiedlichen Lackierungen und Kombinationen erhältlich, z.B. weiß, silber, graphit, schwarz, gold oder kupferfarben. Zu Oberflächenoptionen- und Kombinationen siehe Lightnet-Surface-Collection oder Bi-Colour-Auswahl. Rückversetzte Microprismenoptik mit optimierter Blendungsbegrenzung speziell für Office-Anwendungen. Satinierter Opaldiffusor für Allgemeinbeleuchtung mit max. Transmissionsgrad und homogener Lichtpunktauflösung. Konverter in Leuchtgehäuse integriert, wahlweise einfach schaltbar oder stufenlos dimmbar (DALI, Touch-Dim, Casambi). Farbtemperatur 2200K, 2700K, 3000K, 3500K, 4000K, 6500K oder Tunable White (2700-6500K). Binning initial \leq MacAdam 3. Farbwiedergabe CRI>80, CRI>90 oder Full Spectrum. Auf Anfrage: Integration von Notlichtkomponenten.

EN LED surface-mounted luminaire for walls and ceilings. Direct light distribution and indirect lighting corona. Luminaire body made of aluminum profile. Outer housing and inner decor available in various finishes and combinations, e.g. white, silver, graphite, black, gold or copper coated. For further surface options see Lightnet-Surface-Collection or RAL of your choice. Recessed microprismatic screen with optimized glare reduction especially for workplaces. Satin opal diffuser for general lighting with maximum transmittance and homogeneous lighting. Driver integrated into luminaire housing, optionally switchable or dimmable (DALI, Touch-Dim, Casambi). Colour temperature 2200K, 2700K, 3000K, 3500K, 4000K, 6500K or Tunable White (2700-6500K). Binning \leq MacAdam 3. Colour rendering CRI>80, CRI>90 or Full Spectrum. On request: Integration of emergency lighting components.

B X3 A S L - 8 30 M-D500 - G

Product Family	B: Basic
Type	X3: Direct-Indirect
Optical System	A: Microprismatic, O: Opal Diffuser
Surface Finish	W: Snow White, V: Ivory White, S: Radiant Silver, U: Urban Graphite, B: Jet Black, H: Anodic Champagne, K: Satin Copper
Control Gear	E: On/Off, L: DALI, H: Touch-Dim, C: Casambi [D400-D800], 6: DALI DT6 for TW, 8: DALI DT8 for TW
Colour Rendering	8: CRI>80, 9: CRI>90, F: Full Spectrum [except 2200K]
Colour Temperature	22: 2200K, 27: 2700K, 30: 3000K, 35: 3500K, 40: 4000K, 65: 6500K, TW: Tunable White [D400-D800]
Power	M: Medium Power, H: High Power
Size	Luminaire Diameter in mm: D300, D400, D500, D600, D800
Reflector	W: Snow White, V: Ivory White, S: Radiant Silver, U: Urban Graphite, B: Jet Black, H: Anodic Champagne, K: Satin Copper, G: Satin Gold
On Request	Multisensor [D400-D800], Radar Sensor, Emergency Module [D400-D800]



Microprismatic | Direct-Indirect

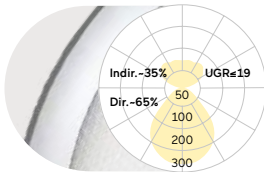

Opal Diffuser | Direct-Indirect

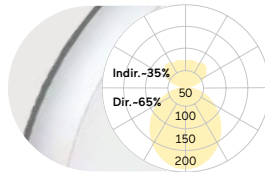

D mm	Lumen/Watt Medium Power	Lumen/Watt High Power	D mm	Lumen/Watt Medium Power	Lumen/Watt High Power
300	1480lm/13W	2530lm/23W	300	1460lm/13W	2500lm/23W
400	2370lm/20W	3750lm/31W	400	2370lm/20W	3750lm/31W
500	3500lm/29W	5810lm/48W	500	3520lm/29W	5870lm/48W
600	5380lm/43W	7750lm/63W	600	5470lm/43W	7850lm/63W
800	7830lm/63W	9940lm/82W	800	7980lm/63W	10110lm/82W

Lumen Values: Luminaire luminous flux at 4000K/CRI>80. Other configurations on request.



Multisensor



Emergency Module



W Snow White
W Snow White



S Radiant Silver
S Radiant Silver



U Urban Graphite
U Urban Graphite



B Jet Black
B Jet Black



H Anodic Champagne
H Anodic Champagne



K Satin Copper
K Satin Copper



W Snow White
B Jet Black

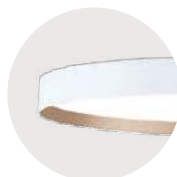

W Snow White
K Satin Copper



W Snow White
G Satin Gold



B Jet Black
W Snow White



H Anodic Champagne
B Jet Black



B Jet Black
G Satin Gold

Basic Déco Z3 | Surface



DE LED-Anbaustrahler für Wand- und Deckenmontage. 345° drehbar und 90° schwenkbar. Leuchtenkörper aus Aluminiumprofil. Gehäuse-Außenfläche und Innendekor in unterschiedlichen Lackierungen und Kombinationen erhältlich, z.B. weiß, silber, graphit, schwarz, gold oder kupferfarben. Zu Oberflächenoptionen- und Kombinationen siehe Lightnet-Surface-Collection oder Bi-Colour-Auswahl. Rückversetzte Microprismenoptik mit optimierter Blendungsbegrenzung speziell für Office-Anwendungen. Sati-nierter Opaldiffusor für Allgemeinbeleuchtung mit max. Transmissionsgrad und homogener Lichtpunktauflösung. Konverter in Leuchtgehäuse integriert, wahlweise einfach schaltbar oder stufenlos dimmbar (DALI). Farbtemperatur 2200K, 2700K, 3000K, 3500K, 4000K oder 6500K. Binning initial \leq MacAdam 3. Farbwiedergabe CRI $>$ 80, CRI $>$ 90 oder Full Spectrum.

EN LED surface-mounted adjustable spotlight for walls or ceilings. 345° rotation and 90° tilt. Luminaire body made of aluminum profile. Outer housing and inner decor available in various finishes and combinations, e.g. white, silver, graphite, black, gold or copper coated. For further surface options see Lightnet-Surface-Collection or RAL of your choice. Recessed microprismatic screen with optimized glare reduction especially for workplaces. Satin opal diffuser for general lighting with maximum transmittance and homogeneous lighting. Driver integrated into luminaire housing, optionally switchable or dimmable (DALI). Colour temperature 2200K, 2700K, 3000K, 3500K, 4000K or 6500K. Binning \leq MacAdam 3. Colour rendering CRI $>$ 80, CRI $>$ 90 or Full Spectrum.

B Z3 A SL-8 30 M-D300-G

- Product Family **B: Basic**
- Type **Z3: Direct only**
- Optical System **A: Microprismatic, O: Opal Diffuser**
- Surface Finish **W: Snow White, V: Ivory White, S: Radiant Silver, U: Urban Graphite, B: Jet Black, H: Anodic Champagne, K: Satin Copper**
- Control Gear **E: On/Off, L: DALI, H: Touch-Dim, C: Casambi**
- Colour Rendering **8: CRI>80, 9: CRI>90, F: Full Spectrum [except 2200K]**
- Colour Temperature **22: 2200K, 27: 2700K, 30: 3000K, 35: 3500K, 40: 4000K, 65: 6500K**
- Power **M: Medium Power, H: High Power**
- Size Luminaire Diameter in mm: **D300**
- Reflector **W: Snow White, V: Ivory White, S: Radiant Silver, U: Urban Graphite, B: Jet Black, H: Anodic Champagne, K: Satin Copper, G: Satin Gold**



Microprismatic | Direct

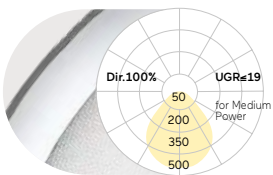

Opal Diffuser | Direct

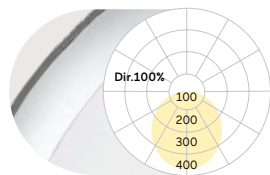

D mm	Lumen/Watt Medium Power	Lumen/Watt High Power	D mm	Lumen/Watt Medium Power	Lumen/Watt High Power
300	830lm/8W	1430lm/13W	300	810lm/8W	1400lm/13W

Lumen Values: Luminaire luminous flux at 4000K/CRI>80. Other configurations on request.

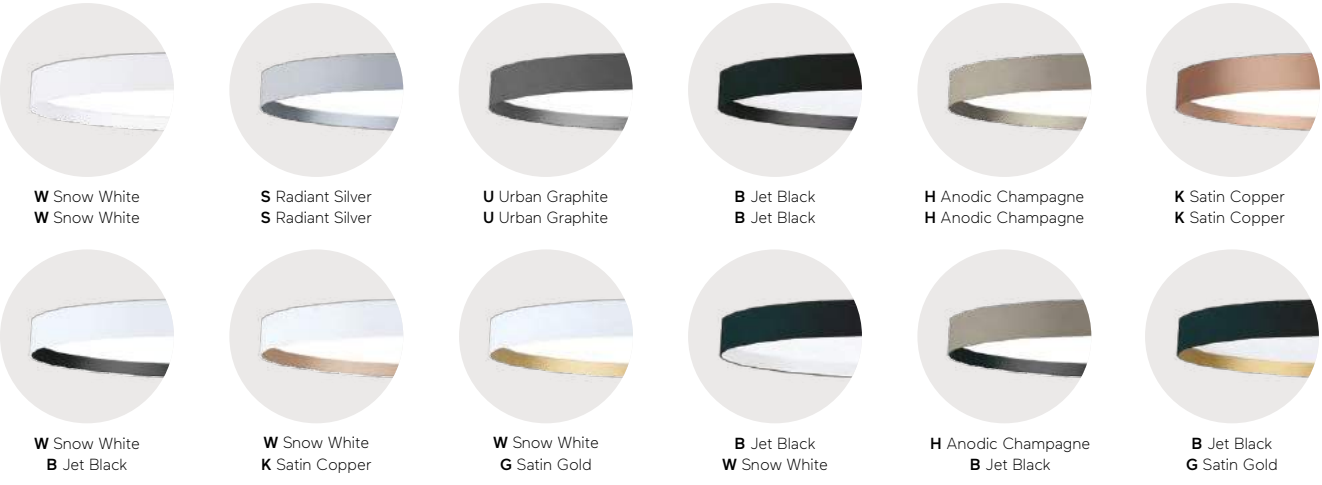
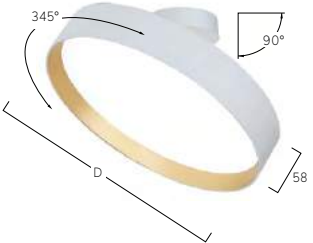

Basic Max A1 | Surface



DE LED-Anbauleuchte für Wand- und Deckenmontage. Rein direktstrahlend. Leuchtenkörper aus Aluminiumprofil mit in 7 verschiedenen Durchmessern von 200 bis 1200mm – bei gleichbleibender Bauhöhe 75mm. Oberfläche weiß, silber, graphit, schwarz, champagner oder kupferfarben lackiert. Weitere Oberflächenoptionen siehe Lightnet-Surface-Collection oder RAL nach Wahl. Microprismenoptik mit optimierter Blendungsbegrenzung speziell für Office-Anwendungen. Opaldiffusor aus satiniertem Acrylglas. Konverter in Leuchtengehäuse integriert, wahlweise einfach schaltbar oder stufenlos dimmbar (DALI, Touch-Dim, Casambi). Farbtemperatur 2200K, 2700K, 3000K, 3500K, 4000K, 6500K oder Tunable White (2700-6500K). Binning initial \leq MacAdam 3. Farbwiedergabe CRI $>$ 80, CRI $>$ 90 oder Full Spectrum. Auf Anfrage: Integration von Notlichtkomponenten, Sensortechnologie.

EN LED surface-mounted luminaire for walls and ceilings. Direct only light distribution. Luminaire body made of aluminum profile in 7 different diameters from 200mm to 1200mm – with overall height of 75mm. Surface white, silver, graphite, black, champagne or copper coated. Further surface options see Lightnet-Surface-Collection or RAL of your choice. Microprismatic screen with optimized glare reduction especially for workplaces. Opal diffuser made of acrylic glass. Driver integrated into luminaire housing, optionally switchable or dimmable (DALI, Touch-Dim, Casambi). Colour temperature 2200K, 2700K, 3000K, 3500K, 4000K, 6500K or Tunable White (2700-6500K). Binning \leq MacAdam 3. Colour rendering CRI $>$ 80, CRI $>$ 90 or Full Spectrum. On request: Integration of emergency lighting components, sensor technology.

BA1 O SL - 8 30 M-D300

- Product Family **B:** Basic
- Type **A1:** Direct only
- Optical System **A:** Microprismatic, **O:** Opal Diffuser
- Surface Finish **W:** Snow White, **V:** Ivory White, **S:** Radiant Silver, **U:** Urban Graphite, **B:** Jet Black, **H:** Anodic Champagne, **K:** Satin Copper
- Control Gear **E:** On/Off, **L:** DALI, **H:** Touch-Dim, **C:** Casambi [D300-D1200], **6:** DALI DT6 for TW, **8:** DALI DT8 for TW
- Colour Rendering **8:** CRI>80, **9:** CRI>90, **F:** Full Spectrum [except 2200K]
- Colour Temperature **22:** 2200K, **27:** 2700K, **30:** 3000K, **35:** 3500K, **40:** 4000K, **65:** 6500K, **TW:** Tunable White 2700-6500K [D400-D1200]
- Power **E:** Low Power, **M:** Medium Power
- Size Luminaire Diameter in mm: **D200, D300, D400, D500, D600, D900, D1200**
- On Request Radar Sensor, Emergency Module [D400-D1200]



Microprismatic | Direct

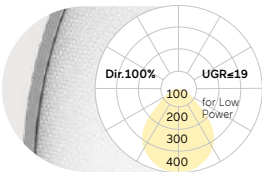

Opal Diffuser | Direct

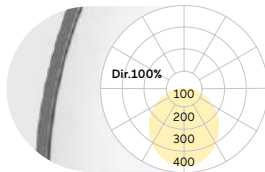

D mm	Lumen/Watt	
	Low Power	Medium Power
200	450lm/5W	1110lm/10W
300	880lm/8W	1730lm/14W
400	1740lm/13W	3580lm/29W
500	2480lm/18W	4860lm/35W
600	3860lm/28W	7250lm/52W
900	6800lm/59W	11490lm/106W
1200	11890lm/107W	20110lm/195W

D mm	Lumen/Watt	
	Low Power	Medium Power
200	470lm/5W	1160lm/10W
300	910lm/8W	1780lm/14W
400	1790lm/13W	3690lm/29W
500	2550lm/18W	5010lm/35W
600	3980lm/28W	7470lm/52W
900	7000lm/59W	11830lm/106W
1200	12250lm/107W	20700lm/195W

Lumen Values: Luminaire luminous flux at 4000K/CRI>80. Other configurations on request.

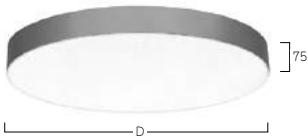

W Snow White



S Radiant Silver



U Urban Graphite



B Jet Black



H Anodic Champagne



K Satin Copper

Basic Max Y1/X1 | Surface



DE LED-Anbauleuchte für Wand- und Deckenmontage. Direktstrahlend mit indirekter Lichtkorona oder rein direktstrahlend. Leuchtenkörper aus Aluminiumprofil mit in 6 verschiedenen Durchmessern von 300 bis 1200mm. Oberfläche weiß, silber, graphit, schwarz, champagner oder kupferfarben lackiert. Weitere Oberflächenoptionen siehe Lightnet-Surface-Collection oder RAL nach Wahl. Microprismenoptik mit optimierter Blendungsbegrenzung speziell für Office-Anwendungen. Opaldiffusor aus satiniertem Acrylglas. Konverter in Leuchtengehäuse integriert, wahlweise einfach schaltbar oder stufenlos dimmbar (DALI, Touch-Dim, Casambi). Farbtemperatur 2200K, 2700K, 3000K, 3500K, 4000K, 6500K oder Tunable White (2700-6500K). Binning initial \leq MacAdam 3. Farbwiedergabe CRI $>$ 80, CRI $>$ 90 oder Full Spectrum. Auf Anfrage: Integration von Notlichtkomponenten, Sensortechnologie.

EN LED surface-mounted luminaire for walls and ceilings. Direct light distribution and indirect lighting corona or direct only light distribution. Luminaire body made of aluminum profile in 6 different diameters from 300mm to 1200mm. Surface white, silver, graphite, black, champagne or copper coated. Further surface options see Lightnet-Surface-Collection or RAL of your choice. Microprismatic screen with optimized glare reduction especially for workplaces. Opal diffuser made of acrylic glass. Driver integrated into luminaire housing, optionally switchable or dimmable (DALI, Touch-Dim, Casambi). Colour temperature 2200K, 2700K, 3000K, 3500K, 4000K, 6500K or Tunable White (2700-6500K). Binning \leq MacAdam 3. Colour rendering CRI $>$ 80, CRI $>$ 90 or Full Spectrum. On request: Integration of emergency lighting components, sensor technology.

B X1 O S L - 8 30 M-D300

- Product Family **B:** Basic
- Type **Y1:** Direct only, **X1:** Direct-Indirect
- Optical System **A:** Microprismatic, **O:** Opal Diffuser
- Surface Finish **W:** Snow White, **V:** Ivory White, **S:** Radiant Silver, **U:** Urban Graphite, **B:** Jet Black, **H:** Anodic Champagne, **K:** Satin Copper
- Control Gear **E:** On/Off, **L:** DALI, **H:** Touch-Dim, **C:** Casambi, **6:** DALI DT6 for TW, **8:** DALI DT8 for TW
- Colour Rendering **8:** CRI>80, **9:** CRI>90, **F:** Full Spectrum [except 2200K]
- Colour Temperature **22:** 2200K, **27:** 2700K, **30:** 3000K, **35:** 3500K, **40:** 4000K, **65:** 6500K, **TW:** Tunable White 2700-6500K [D400-D1200]
- Power **E:** Low Power, **M:** Medium Power
- Size Luminaire Diameter in mm: **D300, D400, D500, D600, D900, D1200**
- On Request Radar Sensor, Emergency Module [D400-D1200]



Microprismatic Direct-Indirect			Microprismatic Direct			Opal Diffuser Direct-Indirect			Opal Diffuser Direct		
D	Lumen/Watt	Lumen/Watt	D	Lumen/Watt	Lumen/Watt	D	Lumen/Watt	Lumen/Watt	D	Lumen/Watt	Lumen/Watt
mm	Low Power	Medium Power	mm	Low Power	Medium Power	mm	Low Power	Medium Power	mm	Low Power	Medium Power
300	1440lm/12W	2810lm/21W	300	880lm/8W	1730lm/14W	300	1470lm/12W	2860lm/21W	300	910lm/8W	1780lm/14W
400	2800lm/19W	5740lm/40W	400	1740lm/13W	3580lm/29W	400	2850lm/19W	5850lm/40W	400	1790lm/13W	3690lm/29W
500	3970lm/29W	7760lm/53W	500	2480lm/18W	4860lm/35W	500	4040lm/29W	7910lm/53W	500	2550lm/18W	5010lm/35W
600	8370lm/55W	12900lm/87W	600	3860lm/28W	7250lm/52W	600	8490lm/55W	13120lm/87W	600	3980lm/28W	7470lm/52W
900	11330lm/88W	17110lm/144W	900	6800lm/59W	11490lm/106W	900	11530lm/88W	17450lm/144W	900	7000lm/59W	11830lm/106W
1200	18140lm/143W	28870lm/251W	1200	11890lm/107W	20110lm/195W	1200	18500lm/143W	29460lm/251W	1200	12250lm/107W	20700lm/195W

Lumen Values: Luminaire luminous flux at 4000K/CRI>80. Other configurations on request.

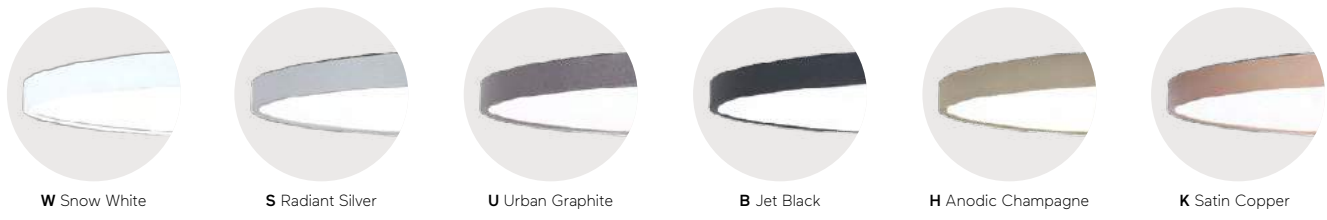

Basic Visio Y9/X9 | Surface



DE LED-Anbauleuchte für Wand- oder Deckenmontage. Direkt-rundumstrahlend für dezente Wand- bzw. Deckenaufhellung oder direkt-indirektstrahlend für stärkere indirekte Lichtkorona. Leuchtenkörper aus gegossenem Acrylglass. Wahlweise Microprismenoptik mit optimierter Blendungsbegrenzung speziell für Office-Anwendungen oder satinierter Opaldiffusor für Allgemeinbeleuchtung mit max. Transmissionsgrad und homogener Lichtpunktauflösung. Distanzelement und Optikträger wahlweise weiß oder graphitfarben. Konverter in Leuchtengehäuse integriert, wahlweise einfach schaltbar oder stufenlos dimmbar (DALI, Touch-Dim, Casambi). Farbtemperatur 2200K, 2700K, 3000K, 3500K, 4000K, 6500K oder Tunable White (2700-6500K). Binning initial \leq MacAdam 3. Farbwiedergabe $\text{CRI} > 80$, $\text{CRI} > 90$ oder Full Spectrum. Auf Anfrage: Integration von Notlichtkomponenten.

EN LED surface-mounted luminaire for walls or ceilings. Direct-omnidirectional light distribution for soft wall or ceiling illumination or direct-indirect light distribution for stronger indirect light distribution. Luminaire body made from cast acrylic glass. Available with microprismatic screen with optimized glare reduction especially for workplaces or satin opal diffuser for general lighting with maximum transmittance and homogeneous lighting. Spacers and lens holder optionally white or graphite coated. Driver integrated into luminaire housing, optionally switchable or dimmable (DALI, Touch-Dim, Casambi). Colour temperature 2200K, 2700K, 3000K, 3500K, 4000K, 6500K or Tunable White (2700-6500K). Binning \leq MacAdam 3. Colour rendering $\text{CRI} > 80$, $\text{CRI} > 90$ or Full Spectrum. On request: Integration of emergency lighting components.

B X9 O WE - 8 30 M-D300

- Product Family **B:** Basic
- Type **Y9:** Direct only, **X9:** Direct-Indirect
- Optical System **A:** Microprismatic, **O:** Opal Diffuser
- Surface Finish **W:** Snow White, **U:** Urban Graphite
- Control Gear **E:** On/Off, **L:** DALI, **H:** Touch-Dim, **C:** Casambi, **6:** DALI DT6 for TW, **8:** DALI DT8 for TW
- Colour Rendering **8:** CRI>80, **9:** CRI>90, **F:** Full Spectrum [except 2200K]
- Colour Temperature **22:** 2200K, **27:** 2700K, **30:** 3000K, **35:** 3500K, **40:** 4000K, **65:** 6500K, **TW:** Tunable White 2700-6500K [D400-D610]
- Power **M:** Medium Power, **H:** High Power
- Size Luminaire Diameter in mm: **D300, D400, D500, D610**



Microprismatic | Direct-Indirect

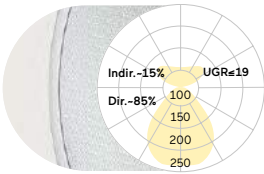

D mm	Lumen/Watt Medium Power	Lumen/Watt High Power
300	760lm/6W	1200lm/10W
400	1770lm/14W	3090lm/23W
500	2840lm/21W	5230lm/38W
610	3830lm/28W	7100lm/52W

Microprismatic | Direct

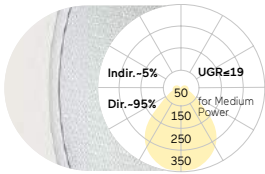

D mm	Lumen/Watt Medium Power	Lumen/Watt High Power
300	630lm/5W	1000lm/9W
400	1630lm/13W	2840lm/22W
500	2470lm/19W	4560lm/34W
610	3340lm/25W	6200lm/46W

Opal Diffuser | Direct-Indirect

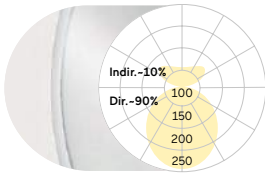

D mm	Lumen/Watt Medium Power	Lumen/Watt High Power
300	800lm/6W	1260lm/10W
400	1870lm/14W	3270lm/23W
500	2990lm/21W	5500lm/38W
610	4040lm/28W	7470lm/52W

Opal Diffuser | Direct

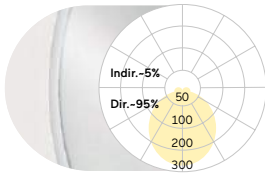

D mm	Lumen/Watt Medium Power	Lumen/Watt High Power
300	670lm/5W	1060lm/9W
400	1730lm/13W	3020lm/22W
500	2620lm/19W	4830lm/34W
610	3550lm/25W	6570lm/46W

Lumen Values: Luminaire luminous flux at 4000K/CRI>80. Other configurations on request.



W Snow White



U Urban Graphite

Beam Me Up (Flat) Y3/X3 | Surface



DE LED-Anbauleuchte für Wand- oder Deckenmontage mit rückversetzter Optik und dekorativem Reflektoring. Direktstrahlend mit indirekter Lichtkorona oder rein direktstrahlend. Leuchtschirm aus hochwertig verarbeitetem Fiberglas. Gehäuse-Außenfläche und dekorativer Reflektoring in unterschiedlichen Lackierungen und Kombinationen erhältlich, z.B. weiß, silber, graphit, schwarz, gold oder kupferfarben lackiert. Zu Oberflächenoptionen- und Kombinationen siehe Lightnet-Surface-Collection oder Bi-Colour-Auswahl. Microprismenoptik mit optimierter Blendungsbegrenzung speziell für Office-Anwendungen. Satinierter Opaldiffusor für Allgemeinbeleuchtung mit max. Transmissionsgrad und homogener Lichtpunktauflösung. Konverter in Leuchtgehäuse integriert, wahlweise einfach schaltbar oder stufenlos dimmbar (DALI, Touch-Dim, Casambi). Farbtemperaturen 2200K, 2700K, 3000K, 3500K, 4000K, 6500K oder Tunable White. Binning initial \leq MacAdam 3. Farbwiedergabe CRI $>$ 80, CRI $>$ 90 oder Full Spectrum.

EN LED surface-mounted luminaire for walls and ceilings with rebated lens optic set in a decorative ring. Direct light distribution and indirect lighting corona or direct only light distribution. Luminaire shade made of high-quality fiber glass. Outer housing and Decorative reflector ring available in various finishes and combinations, e.g. white, silver, graphite, black, gold or copper coated. For further surface options see Lightnet-Surface-Collection or RAL of your choice. Microprismatic screen with optimized glare reduction especially for workplaces. Satin opal diffuser for general lighting with maximum transmittance and homogeneous lighting. Driver integrated into luminaire housing, optionally switchable or dimmable (DALI, Touch-Dim, Casambi). Colour temperature 2200K, 2700K, 3000K, 3500K, 4000K, 6500K or Tunable White. Binning \leq MacAdam 3. Colour rendering CRI $>$ 80, CRI $>$ 90 or Full Spectrum.

M X3 O A L-830 M-D450-G

- Product Family **M:** Beam Me Up
- Type **Y3:** Direct only, **X3:** Direct-Indirect
- Optical System **A:** Microprismatic, **O:** Opal Diffuser
- Surface Finish **W:** Snow White, **V:** Ivory White, **A:** Satin Silver, **U:** Urban Graphite, **B:** Jet Black, **H:** Anodic Champagne, **K:** Satin Copper
- Control Gear **E:** On/Off, **L:** DALI, **H:** Touch-Dim, **C:** Casambi, **6:** DALI DT6 for TW, **8:** DALI DT8 for TW
- Colour Rendering **8:** CRI>80, **9:** CRI>90, **F:** Full Spectrum [except 2200K]
- Colour Temperature **22:** 2200K, **27:** 2700K, **30:** 3000K, **35:** 3500K, **40:** 4000K, **65:** 6500K, **TW:** Tunable White 2700-6500K [D650-D850]
- Power **M:** Medium Power, **H:** High Power
- Size Luminaire Diameter in mm: **D450, D650, D850**
- Reflector **W:** Snow White, **V:** Ivory White, **A:** Satin Silver, **U:** Urban Graphite, **B:** Jet Black, **H:** Anodic Champagne, **K:** Satin Copper, **G:** Satin Gold
- On Request Emergency Module [D650-D850], Radar Sensor

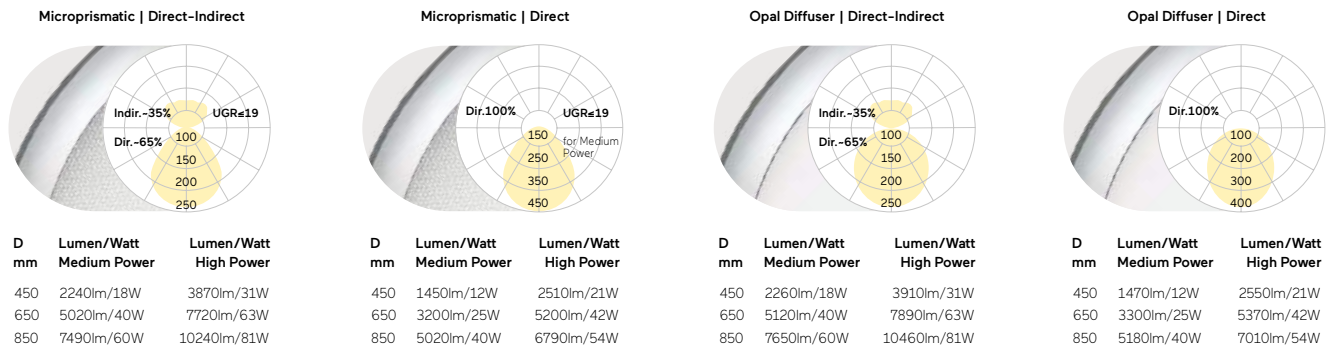

Lumen Values: Luminaire luminous flux at 4000K/CRI>80. Other configurations on request.



Beam Me Up Surface

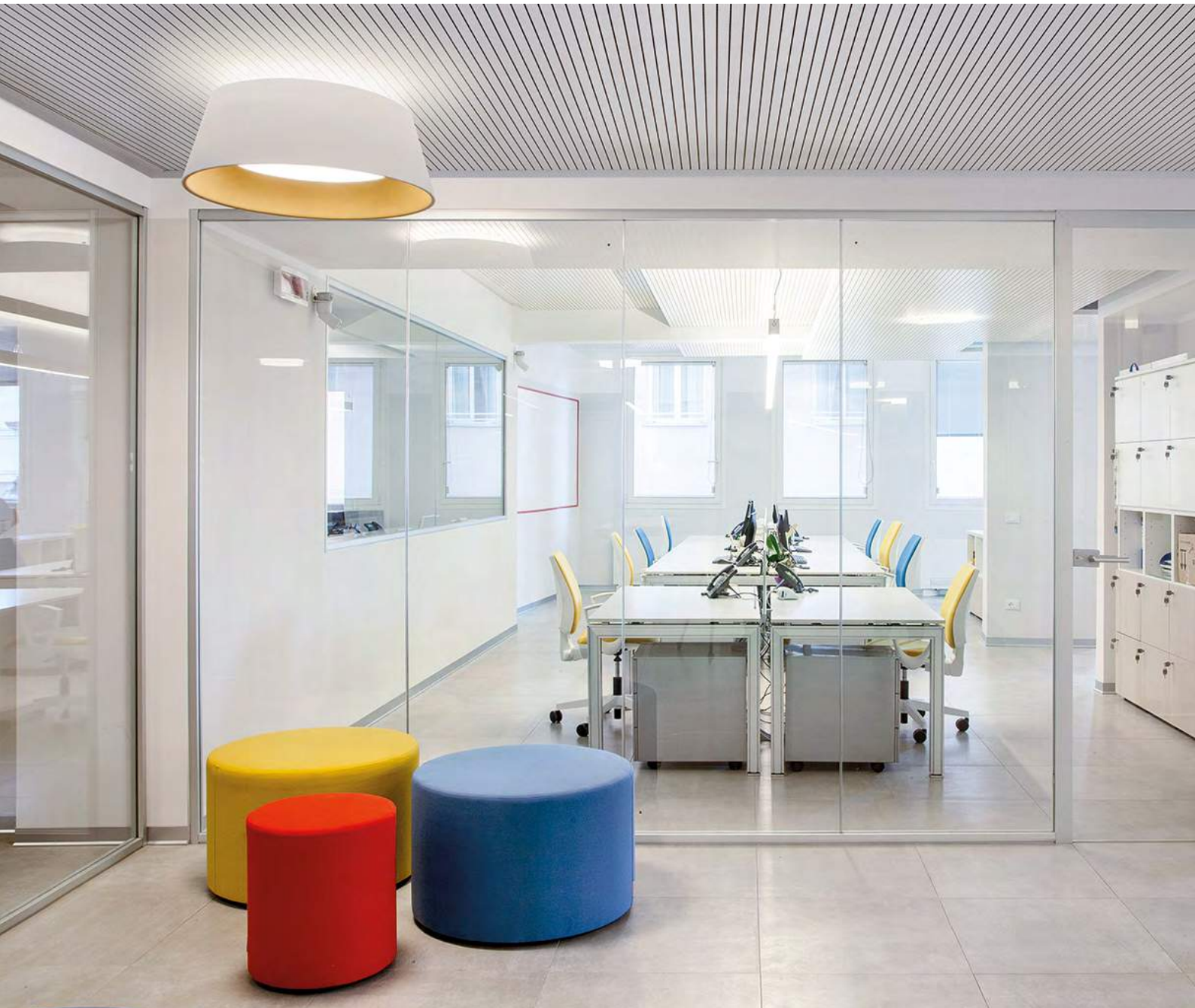



Agras, Genoa, Italy
Beam Me Up X1



Beam Me Up (Max) Y1/X1 | Surface



DE LED-Anbauleuchte für Deckenmontage mit rückversetzter Optik und dekorativem Reflektoring. Direktstrahlend mit indirekter Lichtkorona oder rein direktstrahlend. Leuchtschirm aus hochwertig verarbeitetem Fiberglas. Gehäuse-Außenfläche und dekorativer Reflektoring in unterschiedlichen Lackierungen und Kombinationen erhältlich, z.B. weiß, silber, graphit, schwarz, gold oder kupferfarben lackiert. Zu Oberflächenoptionen- und Kombinationen siehe Lightnet-Surface-Collection oder Bi-Colour-Auswahl. Microprismenoptik mit optimierter Blendungsbegrenzung speziell für Office-Anwendungen. Satinierter Opaldiffusor für Allgemeinbeleuchtung mit max. Transmissionsgrad und homogener Lichtpunktauflösung. Konverter in Leuchtengehäuse integriert, wahlweise einfach schaltbar oder stufenlos dimmbar (DALI, Touch-Dim, Casambi). Farbtemperaturen 2200K, 2700K, 3000K, 3500K, 4000K, 6500K oder Tunable White. Binning initial \leq MacAdam 3. Farbwiedergabe CRI $>$ 80, CRI $>$ 90 oder Full Spectrum.

EN LED surface-mounted luminaire for ceilings with rebated diffuser set in a decorative ring. Direct light distribution and indirect lighting corona or direct only light distribution. Luminaire shade made of high-quality processed fiberglass. Outer housing and Decorative reflector ring available in various finishes and combinations, e.g. white, silver, graphite, black, gold or copper coated. For further surface options see Lightnet-Surface-Collection or RAL of your choice. Microprismatic screen with optimized glare reduction especially for workplaces. Satin opal diffuser for general lighting with maximum transmittance and homogeneous lighting. Driver integrated into luminaire housing, optionally switchable or dimmable (DALI, Touch-Dim, Casambi). Colour temperature 2200K, 2700K, 3000K, 3500K, 4000K, 6500K or Tunable White. Binning \leq MacAdam 3. Colour rendering CRI $>$ 80, CRI $>$ 90 or Full Spectrum.

M X1 O A L-830 M-D400-G

- Product Family **M:** Beam Me Up
- Type **Y1:** Direct only, **X1:** Direct-Indirect
- Optical System **A:** Microprismatic, **O:** Opal Diffuser
- Surface Finish **W:** Snow White, **V:** Ivory White, **A:** Satin Silver, **U:** Urban Graphite, **B:** Jet Black, **H:** Anodic Champagne, **K:** Satin Copper
- Control Gear **E:** On/Off, **L:** DALI, **H:** Touch-Dim, **C:** Casambi, **6:** DALI DT6 for TW, **8:** DALI DT8 for TW
- Colour Rendering **8:** CRI>80, **9:** CRI>90, **F:** Full Spectrum [except 2200K]
- Colour Temperature **22:** 2200K, **27:** 2700K, **30:** 3000K, **35:** 3500K, **40:** 4000K, **65:** 6500K, **TW:** Tunable White 2700-6500K
- Power **M:** Medium Power, **H:** High Power
- Size Luminaire Diameter in mm: **D400, D700, D1200**
- Reflector **W:** Snow White, **V:** Ivory White, **A:** Satin Silver, **U:** Urban Graphite, **B:** Jet Black, **H:** Anodic Champagne, **K:** Satin Copper, **G:** Satin Gold
- On Request Radar Sensor, Emergency Module



Microprismatic | Direct-Indirect

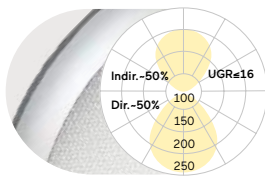

D mm	Lumen/Watt Medium Power	Lumen/Watt High Power
400	2160lm/20W	3160lm/32W
700	5790lm/50W	8490lm/80W
1200	19470lm/177W	26780lm/247W

Microprismatic | Direct

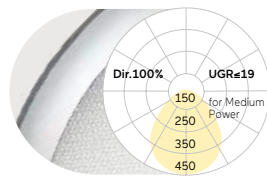

D mm	Lumen/Watt Medium Power	Lumen/Watt High Power
400	1090lm/14W	1600lm/22W
700	2920lm/35W	4290lm/52W
1200	8580lm/104W	11220lm/139W

Opal Diffuser | Direct-Indirect

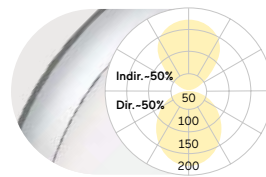

D mm	Lumen/Watt Medium Power	Lumen/Watt High Power
400	2210lm/20W	3240lm/32W
700	5930lm/50W	8690lm/80W
1200	19870lm/177W	27310lm/247W

Opal Diffuser | Direct

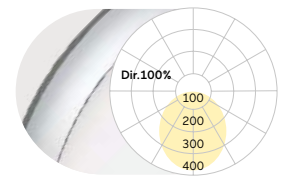

D mm	Lumen/Watt Medium Power	Lumen/Watt High Power
400	1140lm/14W	1680lm/22W
700	3060lm/35W	4490lm/52W
1200	8980lm/104W	11750lm/139W

Lumen Values: Luminaire luminous flux at 4000K/CRI>80. Other configurations on request.

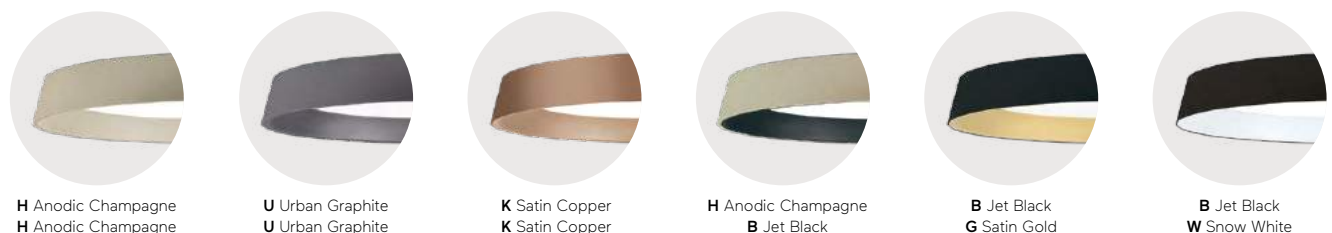

Beam Me Up (Wallwasher) A4 | Surface



DE LED-Anbauleuchte für Deckenmontage mit rückversetzter Optik und dekorativem Reflektoring. Rein direkt- und breitflächig asymmetrisch abstrahlend. Leuchtschirm aus hochwertig verarbeitetem Fiberglas. Gehäuse-Außenfläche und dekorativer Reflektoring in unterschiedlichen Lackierungen und Kombinationen erhältlich, z.B. weiß, silber, graphit, schwarz, gold oder kupferfarben lackiert. Zu Oberflächenoptionen- und Kombinationen siehe Lightnet-Surface-Collection oder Bi-Colour-Auswahl. Microprismenoptik mit optimierter Blendungsbegrenzung speziell für Office-Anwendungen. Satinierter Opaldiffusor für Allgemeinbeleuchtung mit max. Transmissionsgrad und homogener Lichtpunktauflösung. Konverter in Leuchtgehäuse integriert, wahlweise einfach schaltbar oder stufenlos dimmbar (DALI, Touch-Dim, Casambi). Farbtemperaturen 2200K, 2700K, 3000K, 3500K, 4000K, 6500K oder Tunable White. Binning initial \leq MacAdam 3. Farbwiedergabe $\text{CRI} > 80$, $\text{CRI} > 90$ oder Full Spectrum.

EN LED surface-mounted luminaire for ceilings with rebated diffuser set in a decorative ring. Direct only light distribution with wide asymmetrical beam angle. Luminaire shade made of high-quality processed fiberglass. Outer housing and Decorative reflector ring available in various finishes and combinations, e.g. white, silver, graphite, black, gold or copper coated. For further surface options see Lightnet-Surface-Collection or RAL of your choice. Microprismatic screen with optimized glare reduction especially for workplaces. Satin opal diffuser for general lighting with maximum transmittance and homogeneous lighting. Driver integrated into luminaire housing, optionally switchable or dimmable (DALI, Touch-Dim, Casambi). Colour temperature 2200K, 2700K, 3000K, 3500K, 4000K, 6500K or Tunable White. Binning \leq MacAdam 3. Colour rendering $\text{CRI} > 80$, $\text{CRI} > 90$ or Full Spectrum.

M A 4 O A L - 8 3 0 M - D 7 0 0 - G

Product Family	M: Beam Me Up
Type	A4: Direct only
Optical System	A: Microprismatic, O: Opal Diffuser
Surface Finish	W: Snow White, V: Ivory White, A: Satin Silver, U: Urban Graphite, B: Jet Black, H: Anodic Champagne, K: Satin Copper
Control Gear	E: On/Off, L: DALI, H: Touch-Dim, C: Casambi, 6: DALI DT6 for TW, 8: DALI DT8 for TW
Colour Rendering	8: CRI>80, 9: CRI>90, F: Full Spectrum [except 2200K]
Colour Temperature	22: 2200K, 27: 2700K, 30: 3000K, 35: 3500K, 40: 4000K, 65: 6500K, TW: Tunable White 2700-6500K
Power	M: Medium Power, H: High Power
Size	Luminaire Diameter in mm: D700, D1200
Reflector	W: Snow White, V: Ivory White, A: Satin Silver, U: Urban Graphite, B: Jet Black, H: Anodic Champagne, K: Satin Copper, G: Satin Gold
On Request	Radar Sensor, Emergency Module



Microprismatic | Direct

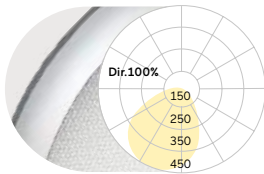

Opal Diffuser | Direct

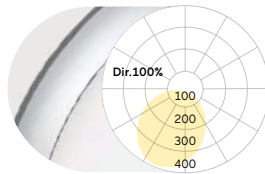

D	Lumen/Watt	Lumen/Watt	D	Lumen/Watt	Lumen/Watt
mm	Medium Power	High Power	mm	Medium Power	High Power
700	3060lm/35W	4490lm/52W	700	3160lm/35W	4650lm/52W
1200	8980lm/104W	11750lm/139W	1200	9300lm/104W	12160lm/139W

Lumen Values: Luminaire luminous flux at 4000K/CRI>80. Other configurations on request.



H Anodic Champagne
H Anodic Champagne



U Urban Graphite
U Urban Graphite



K Satin Copper
K Satin Copper



H Anodic Champagne
B Jet Black



B Jet Black
G Satin Gold



B Jet Black
W Snow White

Ringo Star Compact A5 | Surface



DE LED-Anbauleuchte. Rein direktstrahlend. Leuchtenkörper aus Aluminiumprofil mit 40mm Profillbreite. Kompakte Ausführung mit innenliegendem Blindelement. 3 verschiedene Durchmesser (Ø200, Ø270, Ø370). Oberfläche weiß, silber, graphit, schwarz, champagner oder kupferfarben lackiert. Weitere Oberflächenoptionen siehe Lightnet-Surface-Collection oder RAL nach Wahl. Direktanteil über Präzisionslinsen mit Abblendraster für breite rotationssymmetrische Lichtstärkeverteilung bei gleichzeitig hoher Blendungsbegrenzung (UGR<19) speziell für Office Anwendungen. Abblendraster in verschiedenen Farbkombinationen erhältlich. Konverter im zentralen Blindelement integriert, wahlweise einfach schaltbar oder stufenlos dimmbar (DALI, Touch-Dim). Farbtemperatur 2200K, 2700K, 3000K, 3500K, 4000K oder 6500K. Binning initial ≤ MacAdam 3. Farbwiedergabe CRI>80, CRI>90 oder Full Spectrum. Auf Anfrage: Integration von Sensortechnologie, Lüftungsauslässen, Lautsprechern, Überwachungskameras und zusätzlichen Downlights im zentralen Blindelement.

EN LED surface-mounted luminaire. Direct only light distribution. Luminaire body made of 40mm wide aluminium profile. Compact version with central blank plate. 3 different diameters (Ø200, Ø270, Ø370). Surface white, silver, graphite, black, champagne or copper coated. Further surface options see Lightnet-Surface-Collection or RAL of your choice. Direct light using precision lenses with louvre for wide uniform symmetrical light distribution with high glare limitation (UGR<19) especially for workplaces. Louvre available in various colour finishes. Driver integrated into central blank plate, optionally switchable or dimmable (DALI, Touch-Dim). Colour temperature 2200K, 2700K, 3000K, 3500K, 4000K or 6500K. Binning ≤ MacAdam 3. Colour rendering CRI>80, CRI>90 or Full Spectrum. On request: Integration of sensor technology, ventilation outlets, loudspeakers, surveillance cameras and additional downlights in the central blind element.

R A5 L WE-8 30 E - D200 - W-MP

Product Family	R: Ringo Star
Type	A5: Direct only
Optical System	L: Lens Louvre
Surface Finish	W: Snow White, V: Ivory White, A: Satin Silver, U: Urban Graphite, B: Jet Black, H: Anodic Champagne, K: Satin Copper
Control Gear	E: On/Off, L: DALI, H: Touch-Dim
Colour Rendering	8: CRI>80, 9: CRI>90, F: Full Spectrum [except 2200K]
Colour Temperature	22: 2200K, 27: 2700K, 30: 3000K, 35: 3500K, 40: 4000K, 65: 6500K
Power	E: Low Power, H: High Power
Size	Luminaire Length in mm: D200, D270, D370
Lens Louvre	W: Snow White, A: Satin Silver, B: Jet Black, H: Anodic Champagne, K: Satin Copper, G: Satin Gold
Central Module	For D200: BP: Blind Plate, EM: Emergency Module **, AS: Air Supply **, MM: Multisensor** For D270: BP: Blind Plate, EM: Emergency Module**, AS: Air Supply **, MM: Multisensor** For D370: BP: Blind Plate, EM: Emergency Module**, MM: Multisensor**
On Request	Casambi, Camera * Please specify type ** With external drivers



Lens Louvre | Direct

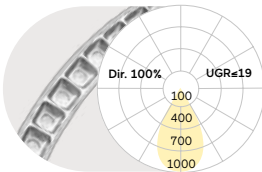

D mm	Lumen/Watt Low Power	Lumen/Watt High Power
200	1570lm/13W	2660lm/23W
270	1860lm/15W	3110lm/26W
370	2480lm/20W	4140lm/34W

Lumen Values: Luminaire luminous flux at 4000K/CRI>80. Other configurations on request.

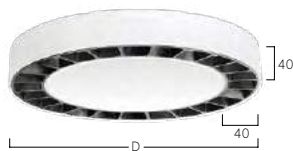

Ringo Star AX | System 40mm Surface



DE LED-Anbauleuchte. Rein direktstrahlend. Leuchtenkörper aus Aluminiumprofil mit 40mm Profildbreite. 5 verschiedene Durchmesser von 600mm bis 2000mm. Oberfläche weiß, silber, graphit, schwarz, champagner oder kupferfarben lackiert. Weitere Oberflächenoptionen siehe Lightnet-Surface-Collection oder RAL nach Wahl. Direktanteil über Präzisionslinsen mit Abblendraster (Ø600-Ø1245) für breite rotationssymmetrische Lichtstärkeverteilung bei gleichzeitig hoher Blendungsbegrenzung (UGR<19) speziell für Office Anwendungen. Abblendraster in verschiedenen Farbkombinationen erhältlich. Satiniertes Opaldiffusor für Allgemeinbeleuchtung mit max. Transmissionsgrad und homogener Lichtpunktauflösung. Konverter in Leuchtgehäuse integriert, wahlweise einfach schaltbar oder stufenlos dimmbar (DALI, Touch-Dim, Casambi). Farbtemperatur 2200K, 2700K, 3000K, 3500K, 4000K oder 6500K. Binning initial \leq MacAdam 3. Farbwiedergabe CRI>80, CRI>90 oder Full Spectrum.

EN LED surface-mounted luminaire. Direct only light distribution. Luminaire body made of 40mm wide aluminium profile. 5 different diameters from 600mm to 2000mm. Surface white, silver, graphite, black, champagne or copper coated. Further surface options see Lightnet-Surface-Collection or RAL of your choice. Direct light using precision lenses with louvre (Ø600-Ø1245) for wide uniform symmetrical light distribution with high glare limitation (UGR<19) especially for workplaces. Louvre available in various colour finishes. Satin opal diffuser for general lighting with maximum transmittance and homogeneous lighting. Driver integrated into luminaire housing, optionally switchable or dimmable (DALI, Touch-Dim, Casambi). Colour temperature 2200K, 2700K, 3000K, 3500K, 4000K or 6500K. Binning \leq MacAdam 3. Colour rendering CRI>80, CRI>90 or Full Spectrum.

RAXLWE-8 30 H-D600-B*

Product Family	R: Ringo Star
Type	AX: Direct only
Optical System	C: Opal Flex Diffuser, L: Lens Louvre* [D600-D1245]
Surface Finish	W: Snow White, V: Ivory White, A: Satin Silver, S: Radiant Silver, U: Urban Graphite, B: Jet Black, H: Anodic Champagne, K: Satin Copper
Control Gear	E: On/Off, L: DALI, C: Casambi, H: Touch-Dim
Colour Rendering	8: CRI>80, 9: CRI>90, F: Full Spectrum [except 2200K]
Colour Temperature	22: 2200K, 27: 2700K, 30: 3000K, 35: 3500K, 40: 4000K, 65: 6500K
Power	E: Low Power, M: Medium Power, H: High Power
Size	Luminaire Diameter in mm: D600, D900, D1245, D1500, D2000
Lens Louvre*	W: Snow White, A: Satin Silver, B: Jet Black, H: Anodic Champagne, K: Satin Copper, G: Satin Gold
On Request	Midpin Spotlights



Lens Louvre | Direct

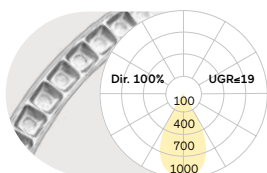

Opal Flex Diffuser | Direct

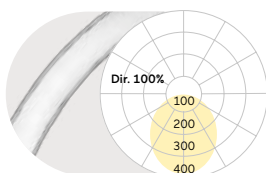

D mm	Lumen/Watt Low Power	Lumen/Watt High Power
600	2850lm/23W	5170lm/42W
900	4350lm/33W	7980lm/66W
1245	6090lm/45W	11170lm/90W

D mm	Lumen/Watt Medium Power	Lumen/Watt High Power
600	2680lm/29W	3740lm/41W
900	4030lm/43W	5610lm/62W
1245	5820lm/62W	7940lm/89W
1500	6730lm/71W	9920lm/108W
2000	9400lm/100W	13210lm/144W

Lumen Values: Luminaire luminous flux at 4000K/CRI>80. Other configurations on request.

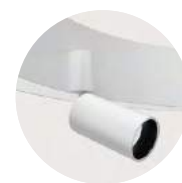

Midpin Spotlight XP
770lm/10W/Ø40mm



W Snow White
W Snow White



W Snow White
A Satin Silver



W Snow White
B Jet Black



W Snow White
G Satin Gold



W Snow White
H Anodic Champagne



W Snow White
K Satin Copper



W Snow White



A Satin Silver



U Urban Graphite



B Jet Black



H Anodic Champagne



K Satin Copper

Ringo Star A3 | System 60mm Surface



DE LED-Anbauleuchte. Rein direktstrahlend. Leuchtenkörper aus Aluminiumprofil mit 60mm Profilbreite. 13 verschiedene Durchmesser von 600mm bis 8000mm. Oberfläche weiß, silber, graphit, schwarz, champagner oder kupferfarben lackiert. Weitere Oberflächenoptionen siehe Lightnet-Surface-Collection oder RAL nach Wahl. Microprismenoptik mit optimierter Blendungsbegrenzung speziell für Office-Anwendungen. Satiniertes Opaldiffusor für Allgemeinbeleuchtung mit max. Transmissionsgrad und homogener Lichtpunktauflösung. Konverter in Leuchtengehäuse integriert, wahlweise einfach schaltbar oder stufenlos dimmbar (DALI, Touch-Dim, Casambi). Farbtemperatur 2200K, 2700K, 3000K, 3500K, 4000K, 6500K oder Tunable White (2700-6500K). Binning initial \leq MacAdam 3. Farbwiedergabe CRI>80, CRI>90 oder Full Spectrum.

EN LED surface-mounted luminaire. Direct only light distribution. Luminaire body made of 60mm wide aluminium profile. 13 different diameters from 600mm to 8000mm. Surface white, silver, graphite, black, champagne or copper coated. Further surface options see Lightnet-Surface-Collection or RAL of your choice. Microprismatic screen with optimized glare reduction especially for workplaces. Satin opal diffuser for general lighting with maximum transmittance and homogeneous lighting. Driver integrated into luminaire housing, optionally switchable or dimmable (DALI, Touch-Dim, Casambi). Colour temperature 2200K, 2700K, 3000K, 3500K, 4000K, 6500K or Tunable White (2700-6500K). Binning \leq MacAdam 3. Colour rendering CRI>80, CRI>90 or Full Spectrum.

R A3 O S L - 8 30 H-D1500

- Product Family **R:** Ringo Star
- Type **A3:** Direct only
- Optical System **A:** Microprismatic, **O:** Opal Diffuser
- Surface Finish **W:** Snow White, **V:** Ivory White, **S:** Radiant Silver, **U:** Urban Graphite, **B:** Jet Black, **H:** Anodic Champagne, **K:** Satin Copper
- Control Gear **E:** On/Off, **L:** DALI, **H:** Touch-Dim, **C:** Casambi, **6:** DALI DT6 for TW, **8:** DALI DT8 for TW
- Colour Rendering **8:** CRI>80, **9:** CRI>90, **F:** Full Spectrum [except 2200K]
- Colour Temperature **22:** 2200K, **27:** 2700K, **30:** 3000K, **35:** 3500K, **40:** 4000K, **65:** 6500K, **TW:** Tunable White 2700-6500K [D1500-D8000]
- Power **E:** Low Power, **M:** Medium Power, **H:** High Power
- Size Luminaire Diameter in mm: **D600, D900, D1200, D1500, D2000, D2500, D3000, D3500, D4000, D5000, D6000, D7000, D8000**
- On Request Emergency Module [D1500-D8000], Midpin Spotlights



Microprismatic | Direct

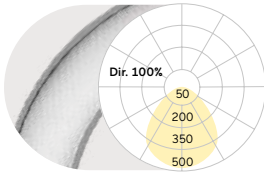

Opal Diffuser | Direct

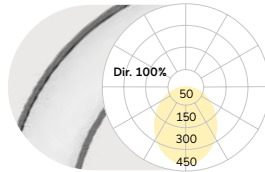

D mm	Lumen/Watt		
	Low Power	Medium Power	High Power
600	2000lm/25W	2920lm/37W	3960lm/53W
900	3190lm/40W	4650lm/59W	6030lm/80W
1200	4450lm/57W	6080lm/81W	8360lm/121W
1500	5620lm/69W	8220lm/106W	10700lm/143W
2000	7500lm/96W	10730lm/142W	14230lm/203W
2500	9140lm/114W	13360lm/173W	17390lm/237W
3000	11240lm/138W	16450lm/211W	21400lm/287W
3500	13350lm/172W	19530lm/259W	25420lm/352W
4000	15420lm/196W	22520lm/297W	29270lm/405W
5000	18970lm/231W	27760lm/356W	36120lm/479W
6000	22490lm/276W	32900lm/423W	42810lm/574W
7000	25300lm/308W	37000lm/474W	48160lm/638W
8000	29520lm/376W	43180lm/568W	56190lm/774W

D mm	Lumen/Watt		
	Low Power	Medium Power	High Power
600	2170lm/25W	3170lm/37W	4300lm/53W
900	3460lm/40W	5050lm/59W	6540lm/80W
1200	4830lm/57W	6600lm/81W	9080lm/121W
1500	6100lm/69W	8920lm/106W	11610lm/143W
2000	8140lm/96W	11650lm/142W	15450lm/203W
2500	9910lm/114W	14500lm/173W	18870lm/237W
3000	12200lm/138W	17850lm/211W	23230lm/287W
3500	14490lm/172W	21200lm/259W	27580lm/352W
4000	16730lm/196W	24440lm/297W	31760lm/405W
5000	20590lm/231W	30120lm/356W	39200lm/479W
6000	24400lm/276W	35700lm/423W	46450lm/574W
7000	27450lm/308W	40160lm/474W	52260lm/638W
8000	32000lm/376W	46850lm/568W	60970lm/774W

Lumen Values: Luminaire luminous flux at 4000K/CRI>80. Other configurations on request.



Midpin Spotlight XP
770lm/10W/Ø40mm

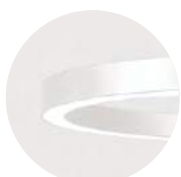

W Snow White



S Radiant Silver



U Urban Graphite



B Jet Black



H Anodic Champagne



K Satin Copper

Ringo Star A1 | System 100mm Surface



DE LED-Anbauleuchte. Rein direktstrahlend. Leuchtenkörper aus Aluminiumprofil mit 100mm Profilbreite. 13 verschiedene Durchmesser von 600mm bis 8000mm. Oberfläche weiß, silber, graphit, schwarz, champagner oder kupferfarben lackiert. Weitere Oberflächenoptionen siehe Lightnet-Surface-Collection oder RAL nach Wahl. Microprismenoptik mit optimierter Blendungsbegrenzung speziell für Office-Anwendungen. Satinierter Opaldiffusor für Allgemeinbeleuchtung mit max. Transmissionsgrad und homogener Lichtpunktauflösung. Konverter in Leuchtengehäuse integriert, wahlweise einfach schaltbar oder stufenlos dimmbar (DALI, Touch-Dim, Casambi). Farbtemperatur 2200K, 2700K, 3000K, 3500K, 4000K, 6500K oder Tunable White (2700-6500K). Binning initial \leq MacAdam 3. Farbwiedergabe CRI $>$ 80, CRI $>$ 90 oder Full Spectrum.

EN LED surface-mounted luminaire. Direct only light distribution. Luminaire body made of 100mm wide aluminium profile. 13 different diameters from 600mm to 8000mm. Surface white, silver, graphite, black, champagne or copper coated. Further surface options see Lightnet-Surface-Collection or RAL of your choice. Microprismatic screen with optimized glare reduction especially for workplaces. Satin opal diffuser for general lighting with maximum transmittance and homogeneous lighting. Driver integrated into luminaire housing, optionally switchable or dimmable (DALI, Touch-Dim, Casambi). Colour temperature 2200K, 2700K, 3000K, 3500K, 4000K, 6500K or Tunable White (2700-6500K). Binning \leq MacAdam 3. Colour rendering CRI $>$ 80, CRI $>$ 90 or Full Spectrum.

R A1 O S L - 8 30 M - D1500

- Product Family **R:** Ringo Star
- Type **A1:** Direct only
- Optical System **A:** Microprismatic, **O:** Opal Diffuser
- Surface Finish **W:** Snow White, **V:** Ivory White, **S:** Radiant Silver, **U:** Urban Graphite, **B:** Jet Black, **H:** Anodic Champagne, **K:** Satin Copper
- Control Gear **E:** On/Off, **L:** DALI, **H:** Touch-Dim, **C:** Casambi, **6:** DALI DT6 for TW, **8:** DALI DT8 for TW [D900-D8000]
- Colour Rendering **8:** CRI>80, **9:** CRI>90, **F:** Full Spectrum [except 2200K]
- Colour Temperature **22:** 2200K, **27:** 2700K, **30:** 3000K, **35:** 3500K, **40:** 4000K, **65:** 6500K, **TW:** Tunable White 2700-6500K
- Power **E:** Low Power, **M:** Medium Power
- Size Luminaire Diameter in mm: **D600, D900, D1200, D1500, D2000, D2500, D3000, D3500, D4000, D5000, D6000, D7000, D8000**
- On Request Emergency Module [D1200-D8000], Midpin/Midpoint Spotlights



Microprismatic | Direct

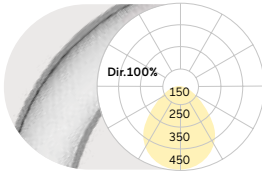

Opal Diffuser | Direct

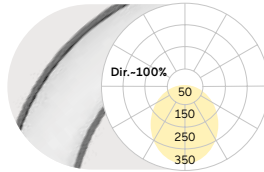

D mm	Lumen/Watt		D mm	Lumen/Watt	
	Low Power	Medium Power		Low Power	Medium Power
600	3810lm/34W	4790lm/45W	600	4090lm/34W	5150lm/45W
900	6460lm/59W	7900lm/75W	900	6930lm/59W	8490lm/75W
1200	8750lm/79W	10260lm/95W	1200	9400lm/79W	11030lm/95W
1500	10980lm/98W	13200lm/120W	1500	11800lm/98W	14180lm/120W
2000	14650lm/131W	18330lm/168W	2000	15730lm/131W	19690lm/168W
2500	18900lm/166W	23090lm/207W	2500	20300lm/166W	24800lm/207W
3000	23260lm/202W	28420lm/252W	3000	24990lm/202W	30520lm/252W
3500	26170lm/227W	31970lm/281W	3500	28110lm/227W	34340lm/281W
4000	30530lm/271W	37290lm/338W	4000	32790lm/271W	40060lm/338W
5000	37800lm/332W	46170lm/414W	5000	40600lm/332W	49600lm/414W
6000	46520lm/405W	56830lm/504W	6000	49970lm/405W	61050lm/504W
7000	55240lm/496W	67490lm/617W	7000	59340lm/496W	72500lm/617W
8000	61780lm/536W	75480lm/667W	8000	66370lm/536W	81080lm/667W

Lumen Values: Luminarie luminous flux at 4000K/CRI>80. Other configurations on request.



Midpoint Spotlight XP
1000lm/19W-3000lm/31W
Ø90mm

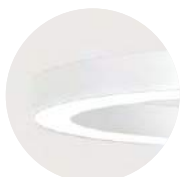

W Snow White



S Radiant Silver

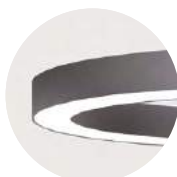

U Urban Graphite



B Jet Black



H Anodic Champagne



K Satin Copper

Liquid Line Compact A5 | Surface



DE LED-Anbauleuchte. Rein direktstrahlend. Leuchtenkörper mit feinen Radien aus Aluminium, gefertigt aus einem Guss ohne sichtbare Nahtstellen an den Stirnseiten. Oberfläche in weiß, silber, graphit, schwarz oder champagnerfarben lackiert. Weitere Oberflächenoptionen siehe Lightnet Surface Collection oder RAL nach Wahl. Präzisionslinsen mit Abblenderaster für breite rotationssymmetrische Lichtstärkeverteilung bei gleichzeitig hoher Blendungsbegrenzung (UGR<19). Abblenderaster in verschiedenen Oberflächen verfügbar. Satinierter Opaldiffusor für Allgemeinbeleuchtung mit max. Transmissionsgrad und homogener Lichtpunktauflösung. Konverter im Leuchtengehäuse integriert, wahlweise einfach schaltbar oder stufenlos dimmbar (DALI). Farbtemperatur 2200K, 2700K, 3000K, 3500K, 4000K oder 6500K. Binning initial \leq MacAdam 3. Farbwiedergabe CRI>80, CRI>90 oder Full Spectrum.

EN LED surface-mounted luminaire. Direct only light distribution. Luminaire body with smooth bends made of aluminium, crafted in one piece with no visible seams. Surface white, silver, graphite, black or champagne coated. Further surface options see Lightnet-Surface-Collection or RAL of your choice. Precision lenses with louvre for wide uniform symmetrical light distribution with high glare limitation (UGR<19). Louvre available in various surfaces. Satin opal diffuser for general lighting with maximum transmittance and homogeneous lighting. Driver integrated into luminaire housing, optionally switchable or dimmable (DALI). Colour temperature 2200K, 2700K, 3000K, 3500K, 4000K or 6500K. Binning \leq MacAdam 3. Colour rendering CRI>80, CRI>90 or Full Spectrum.

Q A5 L W L - 8 30 H - L139 - B*

Product Family	Q: Liquid Line
Type	A5: Direct only
Optical System	O: Opal Diffuser, L: Lens Louvre*
Surface Finish	W: Snow White, V: Ivory White, A: Satin Silver, S: Radiant Silver, U: Urban Graphite, B: Jet Black, H: Anodic Champagne, K: Satin Copper
Control Gear	E: On/Off, L: DALI, H: Touch-Dim
Colour Rendering	8: CRI>80, 9: CRI>90, F: Full Spectrum [except 2200K]
Colour Temperature	22: 2200K, 27: 2700K, 30: 3000K, 35: 3500K, 40: 4000K, 65: 6500K
Power	M: Medium Power, H: High Power
Size	Luminaire Length in mm: L139
Lens Louvre*	W: Snow White, A: Satin Silver, B: Jet Black, H: Anodic Champagne, K: Satin Copper, G: Satin Gold



Lens Louvre | Direct

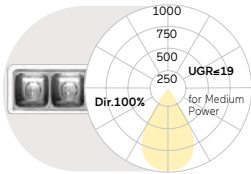

L mm	Lumen/Watt Medium Power	Lumen/Watt High Power
139	620lm/7W	820lm/9W

Opal Diffuser | Direct

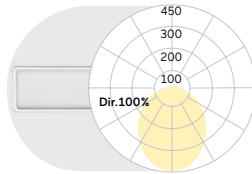

L mm	Lumen/Watt Medium Power	Lumen/Watt High Power
139	530lm/7W	720lm/9W

Lumen Values: Luminaire luminous flux at 4000K/CRI>80. Other configurations on request.

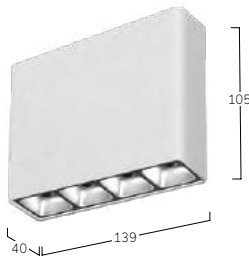

W Snow White



A Satin Silver



U Urban Graphite



B Jet Black

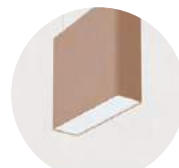

K Satin Copper



H Anodic Champagne

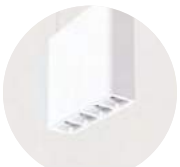

W Snow White
W Snow White

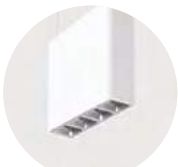

W Snow White
A Satin Silver

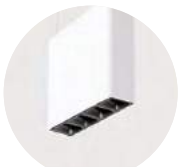

W Snow White
B Jet Black

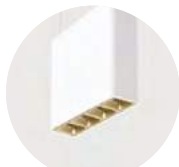

W Snow White
G Satin Gold

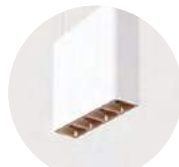

W Snow White
K Satin Copper

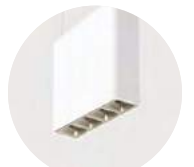

W Snow White
H Anodic Champagne

Liquid Line AX | System 40mm Surface



DE LED-System-Anbauleuchte. Rein direktstrahlend. Hochflexibles System bestehend aus linearen Elementen, vertikal und horizontal gebogenen Elementen sowie Y- und X-Verbindungselementen. Jedes Modul ist dabei als unabhängige Einzelleuchte mit integriertem Konverter konzipiert und kann mit den anderen Modulen durch ein durchdachtes Konnektor-System zu beliebigen Lichtstrukturen verbunden werden. Millimetergenaue Längenfertigung sowie Sonderradien (nur Opal) möglich. Auf Grundlage skizzierter Kundenvorgabe erstellt Lightnet technische Zeichnung der gewünschten Struktur zur Prüfung und Freigabe. Leuchtenkörper mit feinen Radien aus Aluminiumprofil mit 40mm Profildbreite, gefertigt aus einem Guss ohne sichtbare Nahtstellen an den Stirnseiten. Oberfläche

weiß, silber, graphit, schwarz, champagner oder kupferfarben lackiert. Weitere Oberflächenoptionen siehe Lightnet-Surface-Collection oder RAL nach Wahl. Präzisionslinsen mit Abblendraster für breite rotationssymmetrische Lichtstärkeverteilung bei gleichzeitig hoher Blendungsbegrenzung ($UGR < 19$). Abblendraster in verschiedenen Oberflächen verfügbar. Satiniertes Opaldiffusor für Allgemeinbeleuchtung mit max. Transmissionsgrad und homogener Lichtpunktauflösung. Konverter wahlweise einfach schaltbar oder stufenlos dimmbar (DALI, Touch-Dim, Casambi). Farbtemperatur 2200K, 2700K, 3000K, 3500K, 4000K oder 6500K. Binning initial \leq MacAdam 3. Farbwiedergabe CRI > 80, CRI > 90 oder Full Spectrum.

Linear Modules

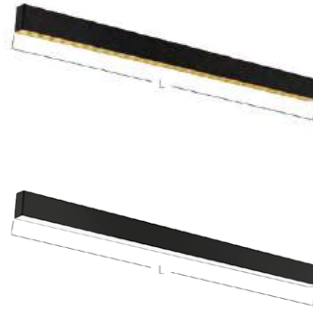

Lens Louvre

L[mm]	668	932	1197	1461	1726	1990
-------	-----	-----	------	------	------	------

Opal Flex Diffuser

L[mm]	600	890	1182	1475	1765	2055
-------	-----	-----	------	------	------	------

Curve Modules

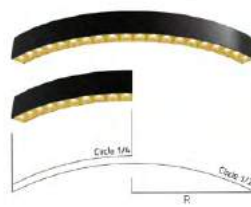

1/2 Curve, Lens Louvre

R[mm]	300	450	622,5
L[mm]	942	1414	1956

1/4 Curve, Lens Louvre

R[mm]	300	450	622,5
L[mm]	471	708	978

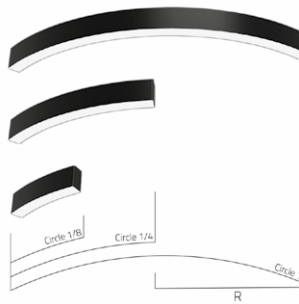

1/2 Curve, Opal Flex Diffuser

R[mm]	300	450	622,5	750
L[mm]	942	1414	1956	2356

1/4 Curve, Opal Flex Diffuser

R[mm]	300	622,5	750	1000
L[mm]	471	978	1178	1570

1/8 Curve, Opal Flex Diffuser

R[mm]	300	622,5	1000
L[mm]	236	489	785

EN LED surface mounted light system. Direct only light distribution. Highly flexible system consisting of linear elements, vertically and horizontally curved elements and Y- and X-connectors. Each module is designed as a stand-alone luminaire with an integrated driver and can be connected to the other modules using a sophisticated connector system to create any desired lighting structure. Millimeter-precise length production as well as special bends (Opal only) possible. Based on customer specification, Lightnet creates technical drawings of the desired structure for review and approval. Luminaire body with smooth bends made of 40mm wide-aluminium profile, crafted in one piece with no visible seams at the ends.

Surface white, silver, graphite, black, champagne or copper coated. Further surface options see Lightnet-Surface-Collection or RAL of your choice. Precision lenses with louvre for wide uniform symmetrical light distribution with high glare limitation (UGR<19). Louvre available in various surfaces. Satin opal diffuser for general lighting with maximum transmittance and homogeneous lighting. Driver optionally switchable or dimmable (DALI, Touch-Dim, Casambi). Colour temperature 2200K, 2700K, 3000K, 3500K, 4000K or 6500K. Binning ≤ MacAdam 3. Colour rendering CRI>80, CRI>90 or Full Spectrum.

Bend Modules

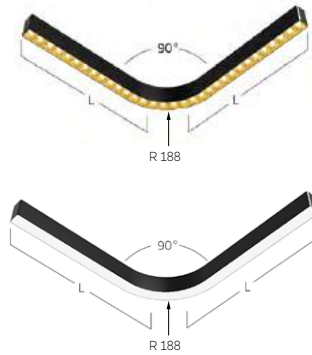

Lens Louvre

L[mm]	584	716	981
-------	-----	-----	-----

Opal Flex Diffuser

L[mm]	580	675	960
-------	-----	-----	-----

Wave Modules

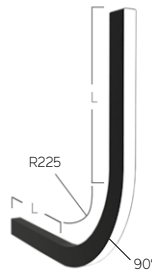

Opal Flex Diffuser

L[mm]	280	375	470
-------	-----	-----	-----

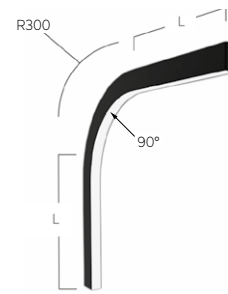

Opal Flex Diffuser

L[mm]	280	375	470
-------	-----	-----	-----

X-Junction Modules

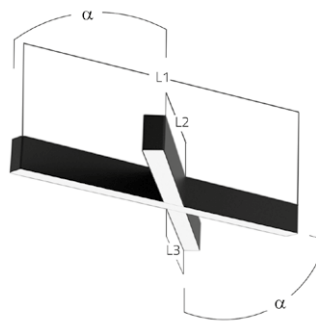
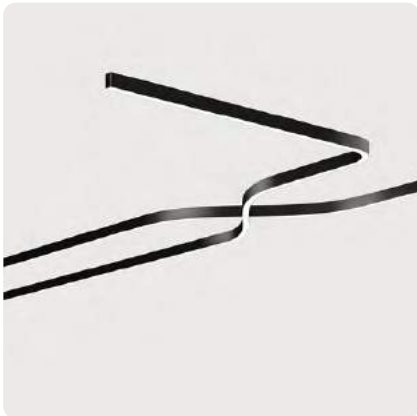

Opal Flex Diffuser

	L1 [mm]	L2 [mm]	L3 [mm]
90°	570	285	285
45°	570	315	315

Y-Junction Modules

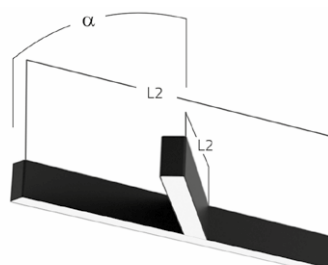

Opal Flex Diffuser

	L1 [mm]	L2 [mm]
90°	570	285
45°	570	315



IP20 ~220-240V 50-60 Hz IK 02 RG0 ≤3 MacAdam L90B10 LOW POWER 50,000h L85B10 MEDIUM POWER 50,000h L82B10 HIGH POWER 50,000h CE UK CA

Lens Louvre | Direct

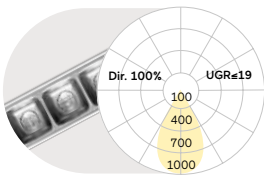

Lumen/Watt Low Power 1640lm/12,6W per m
Lumen/Watt Medium Power 2340lm/18,4W per m
Lumen/Watt High Power 3020lm/24,3W per m

Opal Flex Diffuser | Direct

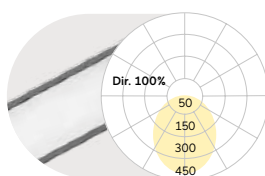

Lumen/Watt Low Power 1110lm/11,1W per m
Lumen/Watt Medium Power 1550lm/15,6W per m
Lumen/Watt High Power 2150lm/21,8W per m



Lumen Values: Luminaire luminous flux at 4000K/CRI>80. Other configurations on request.



Midpin Spotlight XM
770lm/10W/Ø40mm



Midpin Spotlight XP
770lm/10W/Ø40mm



W Snow White

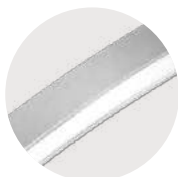

A Satin Silver



U Urban Graphite



B Jet Black



H Anodic Champagne



K Satin Copper

Liquid Line Surface



Creos, Luxemburg
Liquid Line A3

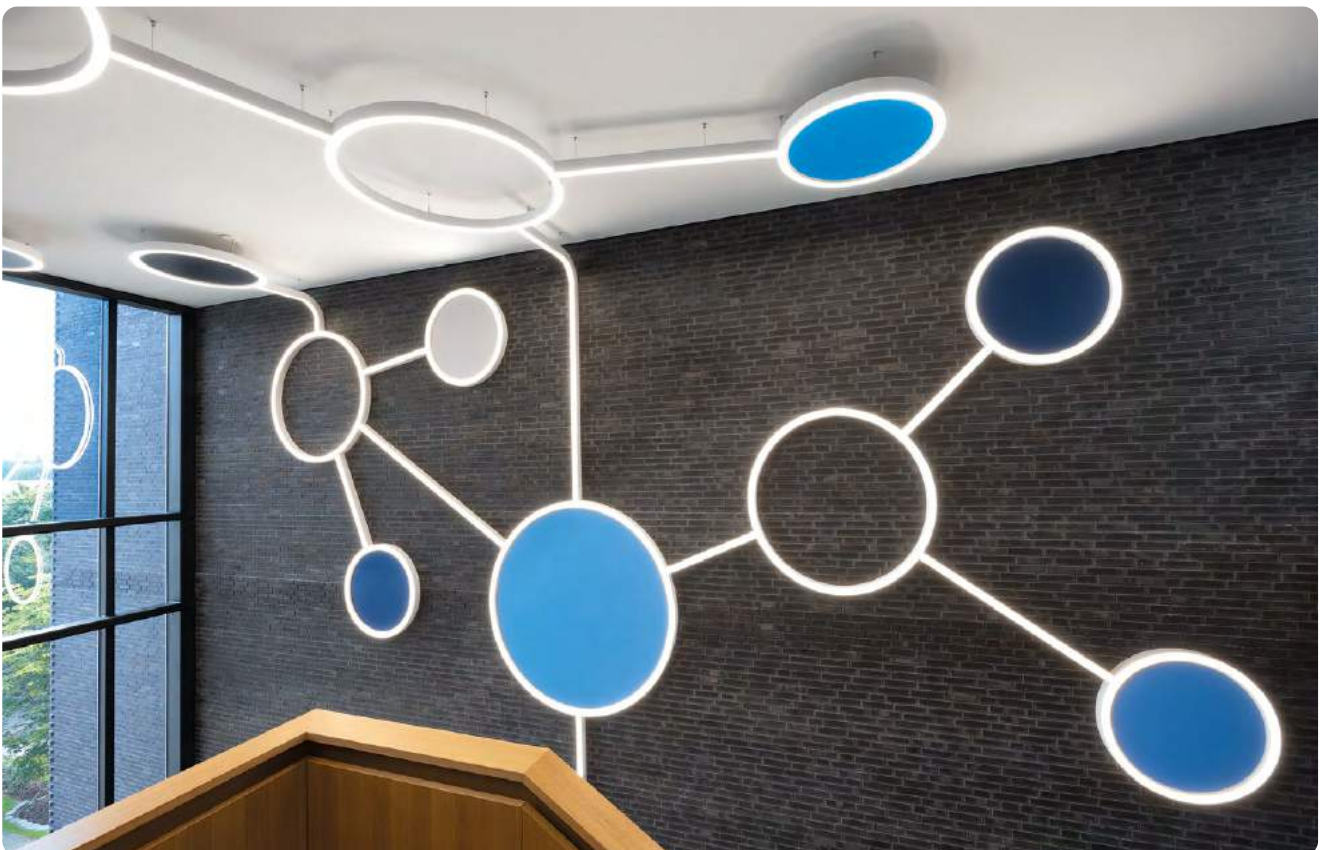



Liquid Line A3 | System 60mm Surface



DE LED-System-Anbauleuchte. Rein direktstrahlend. Hochflexibles System bestehend aus linearen Elementen, vertikal und horizontal gebogenen Elementen sowie Y- und X-Verbindungselementen. Jedes Modul ist dabei als unabhängige Einzeleuchte mit integriertem Konverter konzipiert und kann mit den anderen Modulen durch ein intelligentes Konnektor-System zu beliebigen Lichtstrukturen verbunden werden. Millimetergenaue Längenfertigung sowie Sonderradien durch intelligentes softwarebasiertes Produktionssystem in Stückzahl 1 möglich. Auf Grundlage skizzierter Kundenvorgabe erstellt Lightnet technische Zeichnung der gewünschten Struktur zur Prüfung und Freigabe. Maximale Flexibilität ermöglicht nahezu 100%ige Umsetzung von kundenseitiger Entwurfsskizze in Produktionszeichnung.

Leuchtenkörper mit feinen Radien aus Aluminiumprofil mit 60mm Profilbreite, gefertigt aus einem Guss ohne sichtbare Nahtstellen an den Stirnseiten. Oberfläche weiß, silber, graphit, schwarz, champagner oder kupferfarben lackiert. Weitere Oberflächenoptionen siehe Lightnet-Surface-Collection oder RAL nach Wahl. Microprismenoptik mit optimierter Blendungsbegrenzung speziell für Office-Anwendungen. Satinierter Opaldiffusor für Allgemeinbeleuchtung. Konverter wahlweise einfach schaltbar oder stufenlos dimmbar (DALI, Touch-Dim, Casambi). Farbtemperatur 2200K, 2700K, 3000K, 3500K, 4000K oder 6500K. Binning initial \leq MacAdam 3. Farbwiedergabe CRI>80, CRI>90 oder Full Spectrum.

Linear Modules

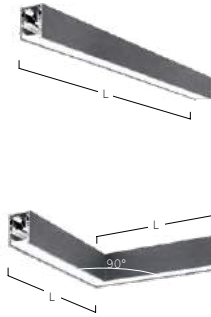

Linear Line

L[mm]	600	888	1178	1472	2340
-------	-----	-----	------	------	------

Sharp Corner

L[mm]	500
-------	-----

Curve Modules



CH 1/2 Curve

R[mm]	500	750	1000
L[mm]	1570	2355	3140



CQ 1/4 Curve

R[mm]	500	750	1000	1250	1500	1750	2000
L[mm]	785	1178	1571	1964	2356	2749	3142



CE 1/8 Curve

R[mm]	1000	1500	2000	2500	3000	3500	4000
L[mm]	785	1178	1571	1964	2356	2749	3142

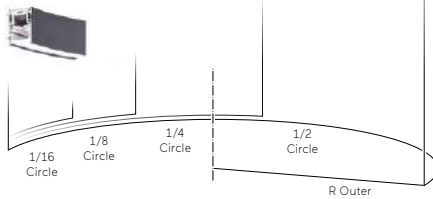

CS 1/16 Curve

R[mm]	2000	3000	3500
L[mm]	785	1178	1374

EN LED surface mounted light system. Direct only light distribution. Highly flexible system consisting of linear elements, vertically and horizontally curved elements and Y- and X-connectors. Each module is designed as a stand-alone luminaire with an integrated driver and can be connected to the other modules using a intelligent connector system to create any desired lighting structure. Millimetre-precise length production as well as special curves possible thanks to intelligent software-based production system. Based on customer specification, Lightnet creates technical drawings of the desired structure for review and approval with the drawings

almost 100% true to the required design. Luminaire body with smooth bends made of aluminium profile with 60mm profile width, crafted in one piece with no visible seams at the ends. Surface white, silver, graphite, black, champagne or copper coated. Further surface options see Lightnet-Surface-Collection or RAL of your choice. Microprismatic screen with optimized glare reduction especially for workplaces. Satin opal diffuser for general lighting. Driver optionally switchable or dimmable (DALI, Touch-Dim, Casambi). Colour temperature 2200K, 2700K, 3000K, 3500K, 4000K or 6500K. Binning ≤ MacAdam 3. Colour rendering CRI>80, CRI>90 or Full Spectrum.

Bend Modules

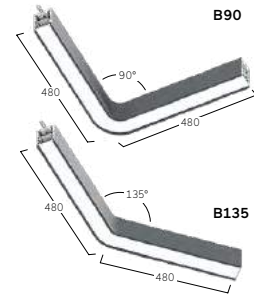
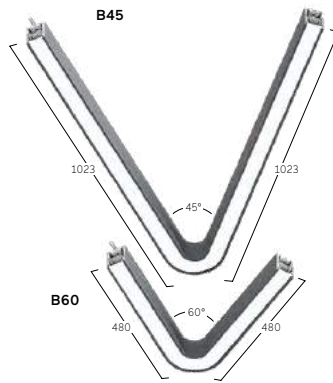

Bend Modules

Type	B45	B60	B90	B135
L[mm]	2046	960	960	960

Wave Modules



WV Concave 1/8 Wave

R[mm]	1000	1250	1500
L[mm]	848	1045	1241



WV Concave 1/6 Wave

R[mm]	1000	1250	1500
L[mm]	1131	1393	1655



WV Concave 1/4 Wave

R[mm]	1000	1250	1500
L[mm]	1696	2089	2482

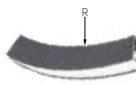

WX Convex 1/8 Wave

R[mm]	1000	1250	1500
L[mm]	848	1045	1241

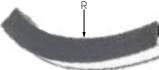

WX Convex 1/6 Wave

R[mm]	1000	1250	1500
L[mm]	1131	1393	1655



WX Convex 1/4 Wave

R[mm]	1000	1250	1500
L[mm]	1696	2089	2482

X-Junction Modules

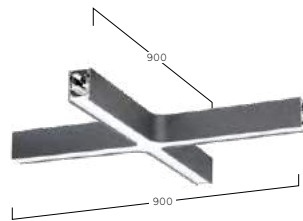

X1-Junction Module

L[mm]	1920
-------	------

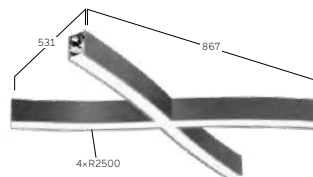

X2-Junction Module

L[mm]	1800
-------	------

Y-Junction Modules

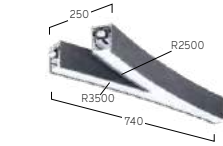

Y1-Junction
L[mm] 1450

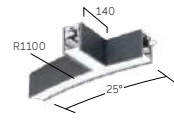

Y4-Junction
L[mm] 620

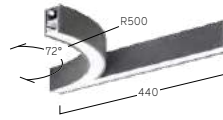

Y2-Junction
L[mm] 1069

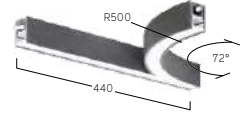

Y5-Junction
L[mm] 1069

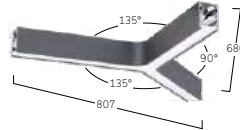

Y3-Junction
L[mm] 1875

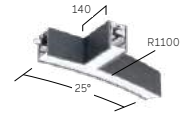

Y6-Junction
L[mm] 620



Microprismatic | Direct

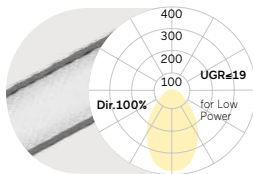

Lumen/Watt Low Power	1200lm/14,6W per m
Lumen/Watt Medium Power	1760lm/22,5W per m
Lumen/Watt High Power	2290lm/30,3W per m

Opal Diffuser | Direct

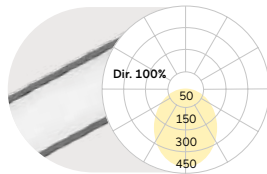

Lumen/Watt Low Power	1300lm/14,6W per m
Lumen/Watt Medium Power	1910lm/22,5W per m
Lumen/Watt High Power	2480lm/30,3W per m

Lumen Values: Luminaire luminous flux at 4000K/CRI>80. Other configurations on request.

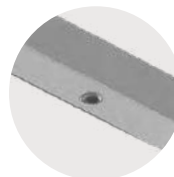
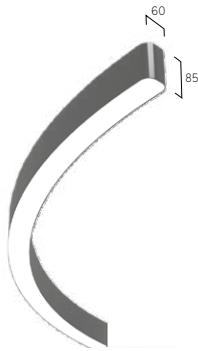

Midpin-Downlight XD
770lm/10W/Ø40mm



Midpin Spotlight XM
770lm/10W/Ø40mm



Midpin Spotlight XP
770lm/10W/Ø40mm



W Snow White

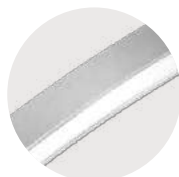

S Radiant Silver

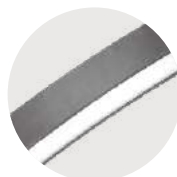

U Urban Graphite



B Jet Black



H Anodic Champagne



K Satin Copper

Caleo Inverse AX | System 40mm Surface



DE LED-Anbauleuchte. Rein direktstrahlend. Leuchtenkörper aus Aluminiumprofil mit 40mm Profilbreite. Im Standard erhältlich in 3 unterschiedlichen Größen. Oberfläche weiß, silber, graphit, schwarz, champagner oder kupferfarben lackiert. Weitere Oberflächenoptionen siehe Lightnet-Surface-Collection oder RAL nach Wahl. Direktanteil über Präzisionslinsen mit Abblendraster für breite rotationssymmetrische Lichtstärkeverteilung bei gleichzeitig hoher Blendungsbegrenzung (UGR<19) speziell für Office Anwendungen. Abblendraster in verschiedenen Farbkombinationen erhältlich. Satinierter Opaldiffusor für Allgemeinbeleuchtung mit max. Transmissionsgrad und homogener Lichtpunktauflösung. Konverter in Leuchtengehäuse integriert, wahlweise einfach schaltbar oder stufenlos dimmbar (DALI, Touch-Dim, Casambi). Farbtemperatur 2200K, 2700K, 3000K, 3500K, 4000K oder 6500K. Binning initial \leq MacAdam 3. Farbwiedergabe CRI>80, CRI>90 oder Full Spectrum. Auf Anfrage: Integration von Notlichtkomponenten, Midpin Spotlights.

EN LED surface-mounted luminaire. Direct only light distribution. Luminaire body made of 40mm wide aluminium profile. As standard available in 3 different sizes. Surface white, silver, graphite, black, champagne or copper coated. Further surface options see Lightnet-Surface-Collection or RAL of your choice. Direct light using precision lenses with louvre for wide uniform symmetrical light distribution with high glare limitation (UGR<19) especially for workplaces. Louvre available in various colour finishes. Satin opal diffuser for general lighting with maximum transmittance and homogeneous lighting. Driver integrated into luminaire housing, optionally switchable or dimmable (DALI, Touch-Dim, Casambi). Colour temperature 2200K, 2700K, 3000K, 3500K, 4000K or 6500K. Binning \leq MacAdam 3. Colour rendering CRI>80, CRI>90 or Full Spectrum. On request: Integration of emergency lighting components, Midpin spotlights.

A AX L WE-8 30 H-Q640 - B*

Product Family	A: Caleo
Type	AX: Direct only
Optical System	C: Opal Flex Diffuser, L: Lens Louvre*
Surface Finish	W: Snow White, V: Ivory White, A: Satin Silver, S: Radiant Silver, U: Urban Graphite, B: Jet Black, H: Anodic Champagne, K: Satin Copper
Control Gear	E: On/Off, L: DALI, C: Casambi, H: Touch-Dim
Colour Rendering	8: CRI>80, 9: CRI>90, F: Full Spectrum [except 2200K]
Colour Temperature	22: 2200K, 27: 2700K, 30: 3000K, 35: 3500K, 40: 4000K, 65: 6500K
Power	E: Low Power, M: Medium Power, H: High Power
Size	Square Size in mm: Q640, Q900, Q1170
Lens Louvre*	W: Snow White, A: Satin Silver, B: Jet Black, H: Anodic Champagne, K: Satin Copper, G: Satin Gold
On Request	Midpin Spotlights, Acoustic Absorber



Lens Louvre | Direct

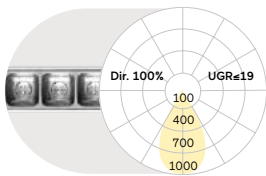

Opal Flex Diffuser | Direct

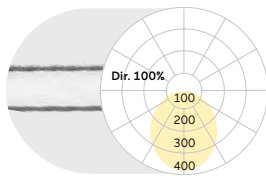

Q mm	Lumen/Watt Low Power	Lumen/Watt High Power	Q mm	Lumen/Watt Medium Power	Lumen/Watt High Power
640	3480lm/27W	6380lm/54W	640	3190lm/34W	4460lm/50W
900	5220lm/39W	9580lm/78W	900	4710lm/49W	6630lm/72W
1170	6960lm/51W	12770lm/104W	1170	6280lm/64W	8840lm/95W

Lumen Values: Luminaire luminous flux at 4000K/CRI>80. Other configurations on request.



Midpin Spotlight XP
770lm/10W/Ø40mm



W Snow White
W Snow White



W Snow White
A Satin Silver



W Snow White
B Jet Black



W Snow White
G Satin Gold



W Snow White
H Anodic Champagne



W Snow White
K Satin Copper



W Snow White



A Satin Silver



U Urban Graphite



B Jet Black



H Anodic Champagne



K Satin Copper

Caleo Neo Y4/X4 | Surface



DE LED-Pendelleuchte. Direktstrahlend mit indirekter Lichtkorona oder rein direktstrahlend. Gestufter Leuchtenkörper aus Aluminiumprofil mit lediglich 25mm sichtbarem Rahmenprofil. Gehäuse-Außenfläche und Innendekor in unterschiedlichen Lackierungen und Kombinationen erhältlich, z.B. weiß, silber, graphit, schwarz, gold oder kupferfarben. Zu Oberflächenoptionen- und Kombinationen siehe Lightnet-Surface-Collection oder Bi-Colour-Auswahl. Rückversetzte Microprismenoptik mit optimierter Blendungsbegrenzung speziell für Office-Anwendungen. Satinierter Opaldiffusor für Allgemeinbeleuchtung mit max. Transmissionsgrad und homogener Lichtpunktauflösung. Konverter in Leuchtengehäuse integriert, wahlweise einfach schaltbar oder stufenlos dimmbar (DALI, Touch-Dim, Casambi). Farbtemperatur 2200K, 2700K, 3000K, 3500K, 4000K oder 6500K. Binning initial \leq MacAdam 3. Farbwiedergabe CRI>80, CRI>90 oder Full Spectrum.

EN LED pendant luminaire. Direct light distribution and indirect lighting corona or direct only light distribution. Tiered luminaire body made of aluminium profile with 25mm visible trim. Outer housing and inner decor available in various finishes and combinations, e.g. white, silver, graphite, black, gold or copper coated. For further surface options see Lightnet-Surface-Collection or RAL of your choice. Recessed microprismatic screen with optimized glare reduction especially for workplaces. Satin opal diffuser for general lighting with maximum transmittance and homogeneous lighting. Driver integrated into luminaire housing, optionally switchable or dimmable (DALI, Touch-Dim, Casambi). Colour temperature 2200K, 2700K, 3000K, 3500K, 4000K or 6500K. Binning \leq MacAdam 3. Colour rendering CRI>80, CRI>90 or Full Spectrum.

A X4 A W E-8 30 M-L900-G

Product Family	A: Caleo
Type	X4: Direct-Indirect, Y4: Direct only
Optical System	A: Microprismatic, O: Opal Diffuser
Surface Finish	W: Snow White, V: Ivory White, S: Radiant Silver, U: Urban Graphite, B: Jet Black, H: Anodic Champagne, K: Satin Copper
Control Gear	E: On/Off, L: DALI, H: Touch-Dim, C: Casambi
Colour Rendering	8: CRI>80, 9: CRI>90, F: Full Spectrum [except 2200K]
Colour Temperature	22: 2200K, 27: 2700K, 30: 3000K, 35: 3500K, 40: 4000K, 65: 6500K
Power	M: Medium Power, H: High Power
Size	Luminaire Length in mm: L900, L1200, L1500
Reflector	W: Snow White, V: Ivory White, A: Satin Silver, U: Urban Graphite, B: Jet Black, H: Anodic Champagne, K: Satin Copper, G: Satin Gold



Microprismatic | Direct-Indirect

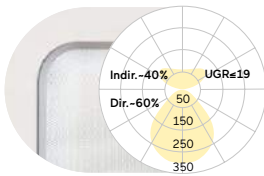

L mm	Lumen/Watt Medium Power	Lumen/Watt High Power
900	3760lm/31W	5070lm/40W
1200	5010lm/39W	6810lm/52W
1500	6480lm/49W	8450lm/65W

Microprismatic | Direct

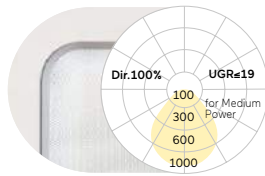

L mm	Lumen/Watt Medium Power	Lumen/Watt High Power
900	2280lm/19W	3150lm/27W
1200	3040lm/24W	4260lm/34W
1500	4020lm/32W	5260lm/42W

Opal Diffuser | Direct-Indirect

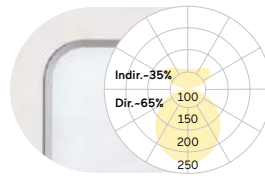

L mm	Lumen/Watt Medium Power	Lumen/Watt High Power
900	3860lm/31W	5210lm/40W
1200	5140lm/39W	6930lm/52W
1500	6610lm/49W	8660lm/65W

Opal Diffuser | Direct

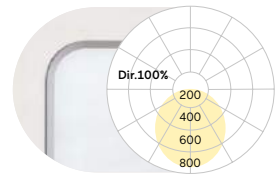

L mm	Lumen/Watt Medium Power	Lumen/Watt High Power
900	2380lm/19W	3290lm/27W
1200	3170lm/24W	4380lm/34W
1500	4150lm/32W	5470lm/42W

Lumen Values: Luminaire luminous flux at 4000K/CRI>80. Other configurations on request.

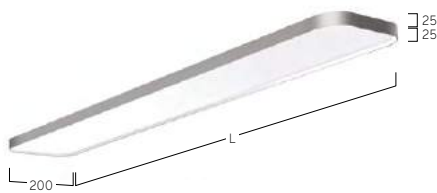

W Snow White
W Snow White



W Snow White
A Satin Silver



W Snow White
B Jet Black



W Snow White
G Satin Gold



W Snow White
H Anodic Champagne



W Snow White
K Satin Copper

Caleo Neo Y6/X6 | Surface



DE LED-Anbauleuchte für Wand- und Deckenmontage. Direktstrahlend mit indirekter Lichtkorona oder rein direktstrahlend. Leuchtenkörper aus Aluminium. Gehäuse-Außenfläche und dekorativer Reflektorring in unterschiedlichen Lackierungen und Kombinationen erhältlich, z.B. weiß, silber, graphit, schwarz, gold oder kupferfarben. Zu Oberflächenoptionen- und Kombinationen siehe Lightnet-Surface-Collection oder Bi-Colour-Auswahl. Rückversetzte Microprismenoptik mit optimierter Blendungsbegrenzung speziell für Office-Anwendungen. Satinierter Opaldiffusor für Allgemeinbeleuchtung mit max. Transmissionsgrad und homogener Lichtpunktauflösung. Konverter in Leuchtengehäuse integriert, wahlweise einfach schaltbar oder stufenlos dimmbar (DALI, Touch-Dim, Casambi). Farbtemperatur 2200K, 2700K, 3000K, 3500K, 4000K, 6500K oder Tunable White (2700-6500K). Binning initial \leq MacAdam 3. Farbwiedergabe CRI $>$ 80, CRI $>$ 90 oder Full Spectrum. Auf Anfrage: Integration von Notlichtkomponenten.

EN LED surface-mounted luminaire for walls and ceilings. Direct and indirect light distribution or direct only light distribution. Luminaire body made of aluminium. Outer housing and Decorative reflector ring available in various finishes and combinations, e.g. white, silver, graphite, black, gold or copper coated For further surface options see Lightnet-Surface-Collection or RAL of your choice. Recessed microprismatic screen with optimized glare reduction especially for workplaces. Satin opal diffuser for general lighting with maximum transmittance and homogeneous lighting. Driver integrated into luminaire housing, optionally switchable or dimmable (DALI, Touch-Dim, Casambi). Colour temperature 2200K, 2700K, 3000K, 3500K, 4000K, 6500K or Tunable White (2700-6500K). Binning \leq MacAdam 3. Colour rendering CRI $>$ 80, CRI $>$ 90 or Full Spectrum. On request: Integration of emergency lighting components.

A X6 A W E-8 30 M-Q300-G

- Product Family **A:** Caleo
- Type **X6:** Direct-Indirect, **Y6:** Direct Only
- Optical System **A:** Microprismatic, **O:** Opal Diffuser
- Surface Finish **W:** Snow White, **V:** Ivory White, **S:** Radiant Silver, **U:** Urban Graphite, **B:** Jet Black, **H:** Anodic Champagne, **K:** Satin Copper
- Control Gear **E:** On/Off, **L:** DALI, **H:** Touch-Dim, **C:** Casambi
- Colour Rendering **8:** CRI>80, **9:** CRI>90, **F:** Full Spectrum [except 2200K]
- Colour Temperature **22:** 2200K, **27:** 2700K, **30:** 3000K, **35:** 3500K, **40:** 4000K, **65:** 6500K
- Power **M:** Medium Power, **H:** High Power
- Size Square size in mm: **Q300, Q400, Q500, Q600**
- Reflector **W:** Snow White, **V:** Ivory White, **A:** Satin Silver, **U:** Urban Graphite, **B:** Jet Black, **H:** Anodic Champagne, **K:** Satin Copper, **G:** Satin Gold



Microprismatic Direct-Indirect			Microprismatic Direct			Opal Diffuser Direct-Indirect			Opal Diffuser Direct			
				Q mm	Lumen/Watt Medium Power	Lumen/Watt High Power	Q mm	Lumen/Watt Medium Power	Lumen/Watt High Power	Q mm	Lumen/Watt Medium Power	Lumen/Watt High Power
300	1990lm/17W	2700lm/22W	300	1230lm/11W	1670lm/15W	300	2000lm/17W	2720lm/22W	300	1240lm/11W	1690lm/15W	
400	2930lm/23W	3890lm/31W	400	2060lm/18W	2720lm/23W	400	2950lm/23W	3910lm/31W	400	2080lm/18W	2740lm/23W	
500	5140lm/39W	6720lm/52W	500	3180lm/26W	4180lm/35W	500	5170lm/39W	6760lm/52W	500	3210lm/26W	4220lm/35W	
600	6790lm/54W	9230lm/73W	600	4800lm/39W	6480lm/53W	600	6830lm/54W	9290lm/73W	600	4840lm/39W	6540lm/53W	

Lumen Values: Luminaire luminous flux at 4000K/CRI>80. Other configurations on request.



Cubic Evolution Y4/X4 | 200mm Surface



DE LED-Anbauleuchte für Wand- oder Deckenmontage. Direktstrahlend mit indirekter Lichtkorona oder rein direktstrahlend. Gestuftes Leuchtenkörper aus Aluminiumprofil mit lediglich 25mm sichtbarem Rahmenprofil. Oberfläche natureloxiert oder weiß, graphit, schwarz bzw. champagnerfarben lackiert. Weitere Oberflächenoptionen siehe Lightnet-Surface-Collection oder RAL nach Wahl. Microprismenoptik mit optimierter Blendungsbegrenzung speziell für Office-Anwendungen. Satinierter Opaldiffusor für Allgemeinbeleuchtung mit max. Transmissionsgrad und homogener Lichtpunktauflösung. Indirektanteil mit innovativer Linsentechnologie für breitstrahlende Deckenaufhellung. Konverter in Leuchtengehäuse integriert, wahlweise einfach schaltbar oder stufenlos dimmbar (DALI, Touch-Dim, Casambi). Farbtemperaturen 2700K, 3000K, 3500K oder 4000K, 6500K oder Tunable White. Binning initial \leq MacAdam 3. Farbwiedergabe CRI $>$ 80, CRI $>$ 90 oder Full Spectrum. Auf Anfrage: Integration von Notlichtkomponenten, Sensortechnologie.

EN LED surface-mounted luminaire for walls or ceilings. Direct and indirect light distribution or direct only light distribution. Tiered luminaire body made of aluminium profile with 25mm visible trim. Surface natural anodised or white, graphite, black or champagne coated. Further surface options see Lightnet-Surface-Collection or RAL of your choice. Microprismatic screen with optimized glare reduction especially for workplaces. Satin opal diffuser for general lighting with maximum transmittance and homogeneous lighting. Indirect light with innovative lens technology for wide-angle ceiling illumination. Driver integrated into luminaire housing, optionally switchable or dimmable (DALI, Touch-Dim, Casambi). Colour temperature 2700K, 3000K, 3500K, 4000K, 6500K or Tunable White. Binning \leq MacAdam 3. Colour rendering CRI $>$ 80, CRI $>$ 90 or Full Spectrum. On request: Integration of emergency lighting components, sensor technology.

C X4 A B E-8 30 M-L900

- Product Family **C:** Cubic
- Type **Y4:** Direct only, **X4:** Direct-Indirect
- Optical System **A:** Microprismatic, **O:** Opal Diffuser
- Surface Finish **W:** Snow White, **E:** Silver Anodised, **U:** Urban Graphite, **B:** Jet Black, **H:** Anodic Champagne
- Control Gear **E:** On/Off, **L:** DALI, **H:** Touch-Dim, **C:** Casambi, **6:** DALI DT6 for TW, **8:** DALI DT8 for TW
- Colour Rendering **8:** CRI>80, **9:** CRI>90, **F:** Full Spectrum [except 2200K]
- Colour Temperature **22:** 2200K, **27:** 2700K, **30:** 3000K, **35:** 3500K, **40:** 4000K, **65:** 6500K, **TW:** Tunable White 2700-6500K
- Power **M:** Medium Power, **H:** High Power
- Size Luminaire Length in mm: **L900, L1200, L1500**
- On Request Emergency Module [L1200-L1500], Multisensor



Microprismatic | Direct-Indirect

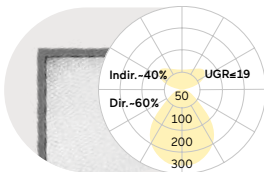

Microprismatic | Direct

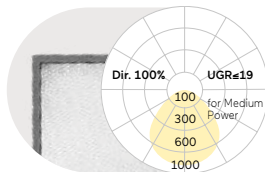

Opal Diffuser | Direct-Indirect

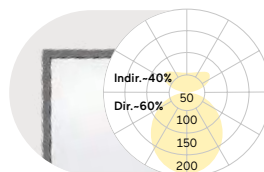

Opal Diffuser | Direct

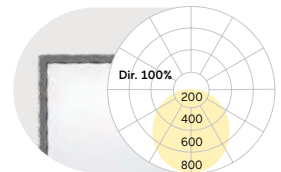

L mm	Lumen/Watt		L mm	Lumen/Watt		L mm	Lumen/Watt		L mm	Lumen/Watt	
	Medium Power	High Power		Medium Power	High Power		Medium Power	High Power		Medium Power	High Power
900	3790lm/30W	5000lm/40W	900	2280lm/21W	2930lm/26W	900	3750lm/30W	4950lm/40W	900	2170lm/21W	2730lm/26W
1200	5020lm/39W	6560lm/52W	1200	3050lm/27W	3900lm/34W	1200	4930lm/39W	6510lm/52W	1200	2890lm/27W	3650lm/34W
1500	6160lm/48W	8270lm/65W	1500	3700lm/32W	4880lm/43W	1500	6090lm/48W	8160lm/65W	1500	3460lm/32W	4560lm/43W

Lumen Values: Luminaire luminous flux at 4000K/CRI>80. Other configurations on request.



Multisensor



Emergency Module



W Snow White



E Silver Anodised



U Urban Graphite



B Jet Black



H Anodic Champagne

Cubic Evolution Y5/X5 | 300mm Surface



DE LED-Anbauleuchte für Wand- oder Deckenmontage. Direktstrahlend mit indirekter Lichtkorona oder rein direktstrahlend. Gestuftes Leuchtenkörper aus Aluminiumprofil mit lediglich 25mm sichtbarem Rahmenprofil. Oberfläche natureloxiert oder weiß, graphit, schwarz bzw. champagnerfarben lackiert. Weitere Oberflächenoptionen siehe Lightnet-Surface-Collection oder RAL nach Wahl. Microprismenoptik mit optimierter Blendungsbegrenzung speziell für Office-Anwendungen. Satinierter Opaldiffusor für Allgemeinbeleuchtung mit max. Transmissionsgrad und homogener Lichtpunktauflösung. Indirektanteil mit innovativer Linsentechnologie für breitstrahlende Deckenaufhellung. Konverter in Leuchtengehäuse integriert, wahlweise einfach schaltbar oder stufenlos dimmbar (DALI, Touch-Dim, Casambi). Farbtemperaturen 2700K, 3000K, 3500K oder 4000K, 6500K oder Tunable White. Binning initial \leq MacAdam 3. Farbwiedergabe CRI $>$ 80, CRI $>$ 90 oder Full Spectrum. Auf Anfrage: Integration von Notlichtkomponenten, Sensortechnologie.

EN LED surface-mounted luminaire for walls or ceilings. Direct and indirect light distribution or direct only light distribution. Tiered luminaire body made of aluminium profile with 25mm visible frame. Surface natural anodised or white, graphite, black or champagne coated. Further surface options see Lightnet-Surface-Collection or RAL of your choice. Microprismatic screen with optimized glare reduction especially for workplaces. Satin opal diffuser for general lighting with maximum transmittance and homogeneous lighting. Indirect light with innovative lens technology for wide-angle ceiling illumination. Driver integrated into luminaire housing, optionally switchable or dimmable (DALI, Touch-Dim, Casambi). Colour temperature 2700K, 3000K, 3500K, 4000K, 6500 or Tunable White. Binning \leq MacAdam 3. Colour rendering CRI $>$ 80, CRI $>$ 90 or Full Spectrum. On request: Integration of emergency lighting components, sensor technology.

C X5 A B E - 8 30 M - L900

- Product Family **C:** Cubic
- Type **Y5:** Direct only, **X5:** Direct-Indirect
- Optical System **A:** Microprismatic, **O:** Opal Diffuser
- Surface Finish **W:** Snow White, **E:** Silver Anodised, **U:** Urban Graphite, **B:** Jet Black, **H:** Anodic Champagne
- Control Gear **E:** On/Off, **L:** DALI, **H:** Touch-Dim, **C:** Casambi, **6:** DALI DT6 for TW, **8:** DALI DT8 for TW
- Colour Rendering **8:** CRI>80, **9:** CRI>90, **F:** Full Spectrum [except 2200K]
- Colour Temperature **22:** 2200K, **27:** 2700K, **30:** 3000K, **35:** 3500K, **40:** 4000K, **65:** 6500K, **TW:** Tunable White 2700-6500K
- Power **M:** Medium Power, **H:** High Power
- Size Luminaire Length in mm: **L900, L1200, L1500**
- On Request Emergency Module [L1200-L1500], Multisensor

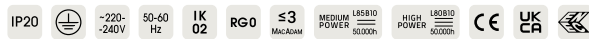

Microprismatic | Direct-Indirect

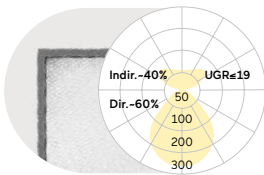

L mm	Lumen/Watt Medium Power	Lumen/Watt High Power
900	5220lm/39W	7430lm/55W
1200	6990lm/51W	9910lm/74W
1500	8590lm/62W	12350lm/91W

Microprismatic | Direct

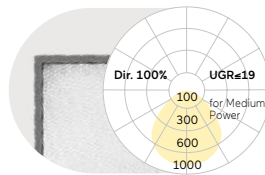

L mm	Lumen/Watt Medium Power	Lumen/Watt High Power
900	3220lm/25W	4600lm/35W
1200	4290lm/33W	6140lm/48W
1500	5370lm/40W	7670lm/59W

Opal Diffuser | Direct-Indirect

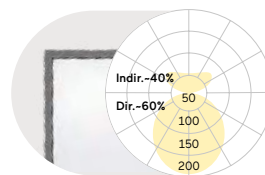

L mm	Lumen/Watt Medium Power	Lumen/Watt High Power
900	5030lm/39W	7140lm/55W
1200	6740lm/51W	9510lm/74W
1500	8270lm/62W	11850lm/91W

Opal Diffuser | Direct

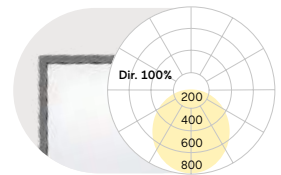

L mm	Lumen/Watt Medium Power	Lumen/Watt High Power
900	3030lm/25W	4310lm/35W
1200	4040lm/33W	5740lm/48W
1500	5050lm/40W	7170lm/59W

Lumen Values: Luminaire luminous flux at 4000K/CRI>80. Other configurations on request.

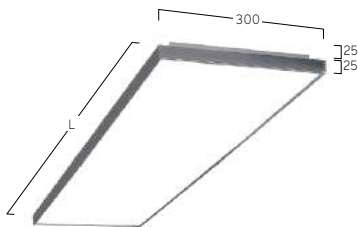

Multisensor



Emergency Module



W Snow White



E Silver Anodised



U Urban Graphite



B Jet Black



H Anodic Champagne

Cubic Evolution Y6/X6 | Square Surface



DE LED-Anbauleuchte für Wand- oder Deckenmontage. Direktstrahlend mit indirekter Lichtkorona oder rein direktstrahlend. Gestufter Leuchtenkörper aus Aluminiumprofil mit lediglich 25mm sichtbarem Rahmenprofil. Oberfläche natureloxiert oder weiß, graphit, schwarz bzw. champagnerfarben lackiert. Weitere Oberflächenoptionen siehe Lightnet-Surface-Collection oder RAL nach Wahl. Microprismenoptik mit optimierter Blendungsbegrenzung speziell für Office-Anwendungen. Satinierter Opaldiffusor für Allgemeinbeleuchtung mit max. Transmissionsgrad und homogener Lichtpunkt auflösung. Indirektanteil mit innovativer Linsentechnologie für breitstrahlende Deckenaufhellung. Konverter in Leuchtengehäuse integriert, wahlweise einfach schaltbar oder stufenlos dimmbar (DALI, Touch-Dim, Casambi). Farbtemperaturen 2700K, 3000K, 3500K oder 4000K, 6500K oder Tunable White. Binning initial \leq MacAdam 3. Farbwiedergabe CRI $>$ 80, CRI $>$ 90 oder Full Spectrum. Auf Anfrage: Integration von Notlichtkomponenten, Sensortechnologie.

EN LED surface-mounted luminaire for walls or ceilings. Direct and indirect light distribution or direct only light distribution. Tiered luminaire body made of aluminium profile with only 25mm visible trim. Surface natural anodised or white, graphite, black or champagne coated. Further surface options see Lightnet-Surface-Collection or RAL of your choice. Microprismatic screen with optimized glare reduction especially for workplaces. Satin opal diffuser for general lighting with maximum transmittance and homogeneous lighting. Indirect light with innovative lens technology for wide-angle ceiling illumination. Driver integrated into luminaire housing, optionally switchable or dimmable (DALI, Touch-Dim, Casambi). Colour temperature 2700K, 3000K, 3500K, 4000K, 6500K or Tunable White. Binning \leq MacAdam 3. Colour rendering CRI $>$ 80, CRI $>$ 90 or Full Spectrum. On request: Integration of emergency lighting components, sensor technology.

C X6 A B E-8 30 M-Q600

- Product Family **C:** Cubic
- Type **Y6:** Direct only, **X6:** Direct-Indirect
- Optical System **A:** Microprismatic, **O:** Opal Diffuser
- Surface Finish **W:** Snow White, **E:** Silver Anodised, **U:** Urban Graphite, **B:** Jet Black, **H:** Anodic Champagne
- Control Gear **E:** On/Off, **L:** DALI, **H:** Touch-Dim, **C:** Casambi, **6:** DALI DT6 for TW, **8:** DALI DT8 for TW
- Colour Rendering **8:** CRI>80, **9:** CRI>90, **F:** Full Spectrum [except 2200K]
- Colour Temperature **22:** 2200K, **27:** 2700K, **30:** 3000K, **35:** 3500K, **40:** 4000K, **65:** 6500K, **TW:** Tunable White 2700-6500K [Q400-Q800]
- Power **M:** Medium Power, **H:** High Power
- Size Square size in mm: **Q300, Q400, Q500, Q600, Q800**
- On Request Emergency Module [Q400-Q800], Multisensor



Microprismatic Direct-Indirect	Microprismatic Direct	Opal Diffuser Direct-Indirect	Opal Diffuser Direct																																																																								
<table border="1" style="width: 100%; border-collapse: collapse;"> <thead> <tr> <th>Q mm</th> <th>Lumen/Watt Medium Power</th> <th>Lumen/Watt High Power</th> </tr> </thead> <tbody> <tr><td>300</td><td>1970lm/16W</td><td>2850lm/24W</td></tr> <tr><td>400</td><td>2920lm/23W</td><td>4170lm/32W</td></tr> <tr><td>500</td><td>4580lm/33W</td><td>5900lm/44W</td></tr> <tr><td>600</td><td>7240lm/55W</td><td>9850lm/76W</td></tr> <tr><td>800</td><td>10590lm/76W</td><td>14950lm/109W</td></tr> </tbody> </table>	Q mm	Lumen/Watt Medium Power	Lumen/Watt High Power	300	1970lm/16W	2850lm/24W	400	2920lm/23W	4170lm/32W	500	4580lm/33W	5900lm/44W	600	7240lm/55W	9850lm/76W	800	10590lm/76W	14950lm/109W	<table border="1" style="width: 100%; border-collapse: collapse;"> <thead> <tr> <th>Q mm</th> <th>Lumen/Watt Medium Power</th> <th>Lumen/Watt High Power</th> </tr> </thead> <tbody> <tr><td>300</td><td>1210lm/11W</td><td>1740lm/16W</td></tr> <tr><td>400</td><td>1960lm/16W</td><td>2860lm/24W</td></tr> <tr><td>500</td><td>3330lm/26W</td><td>4290lm/34W</td></tr> <tr><td>600</td><td>5250lm/40W</td><td>7100lm/55W</td></tr> <tr><td>800</td><td>7590lm/55W</td><td>10630lm/78W</td></tr> </tbody> </table>	Q mm	Lumen/Watt Medium Power	Lumen/Watt High Power	300	1210lm/11W	1740lm/16W	400	1960lm/16W	2860lm/24W	500	3330lm/26W	4290lm/34W	600	5250lm/40W	7100lm/55W	800	7590lm/55W	10630lm/78W	<table border="1" style="width: 100%; border-collapse: collapse;"> <thead> <tr> <th>Q mm</th> <th>Lumen/Watt Medium Power</th> <th>Lumen/Watt High Power</th> </tr> </thead> <tbody> <tr><td>300</td><td>1930lm/16W</td><td>2760lm/24W</td></tr> <tr><td>400</td><td>2870lm/23W</td><td>4120lm/32W</td></tr> <tr><td>500</td><td>4550lm/33W</td><td>5880lm/44W</td></tr> <tr><td>600</td><td>7170lm/55W</td><td>9750lm/76W</td></tr> <tr><td>800</td><td>10370lm/76W</td><td>14440lm/109W</td></tr> </tbody> </table>	Q mm	Lumen/Watt Medium Power	Lumen/Watt High Power	300	1930lm/16W	2760lm/24W	400	2870lm/23W	4120lm/32W	500	4550lm/33W	5880lm/44W	600	7170lm/55W	9750lm/76W	800	10370lm/76W	14440lm/109W	<table border="1" style="width: 100%; border-collapse: collapse;"> <thead> <tr> <th>Q mm</th> <th>Lumen/Watt Medium Power</th> <th>Lumen/Watt High Power</th> </tr> </thead> <tbody> <tr><td>300</td><td>1170lm/11W</td><td>1650lm/16W</td></tr> <tr><td>400</td><td>1910lm/16W</td><td>2810lm/24W</td></tr> <tr><td>500</td><td>3300lm/26W</td><td>4270lm/34W</td></tr> <tr><td>600</td><td>5180lm/40W</td><td>7000lm/55W</td></tr> <tr><td>800</td><td>7370lm/55W</td><td>10120lm/78W</td></tr> </tbody> </table>	Q mm	Lumen/Watt Medium Power	Lumen/Watt High Power	300	1170lm/11W	1650lm/16W	400	1910lm/16W	2810lm/24W	500	3300lm/26W	4270lm/34W	600	5180lm/40W	7000lm/55W	800	7370lm/55W	10120lm/78W
Q mm	Lumen/Watt Medium Power	Lumen/Watt High Power																																																																									
300	1970lm/16W	2850lm/24W																																																																									
400	2920lm/23W	4170lm/32W																																																																									
500	4580lm/33W	5900lm/44W																																																																									
600	7240lm/55W	9850lm/76W																																																																									
800	10590lm/76W	14950lm/109W																																																																									
Q mm	Lumen/Watt Medium Power	Lumen/Watt High Power																																																																									
300	1210lm/11W	1740lm/16W																																																																									
400	1960lm/16W	2860lm/24W																																																																									
500	3330lm/26W	4290lm/34W																																																																									
600	5250lm/40W	7100lm/55W																																																																									
800	7590lm/55W	10630lm/78W																																																																									
Q mm	Lumen/Watt Medium Power	Lumen/Watt High Power																																																																									
300	1930lm/16W	2760lm/24W																																																																									
400	2870lm/23W	4120lm/32W																																																																									
500	4550lm/33W	5880lm/44W																																																																									
600	7170lm/55W	9750lm/76W																																																																									
800	10370lm/76W	14440lm/109W																																																																									
Q mm	Lumen/Watt Medium Power	Lumen/Watt High Power																																																																									
300	1170lm/11W	1650lm/16W																																																																									
400	1910lm/16W	2810lm/24W																																																																									
500	3300lm/26W	4270lm/34W																																																																									
600	5180lm/40W	7000lm/55W																																																																									
800	7370lm/55W	10120lm/78W																																																																									

Lumen Values: Luminarie luminous flux at 4000K/CRI>80. Other configurations on request.

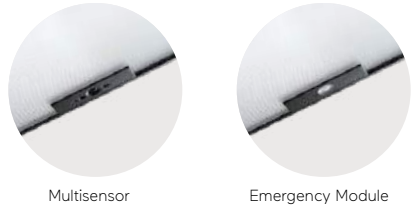
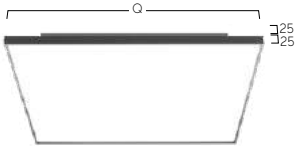

Cubic Neo A9 | Surface

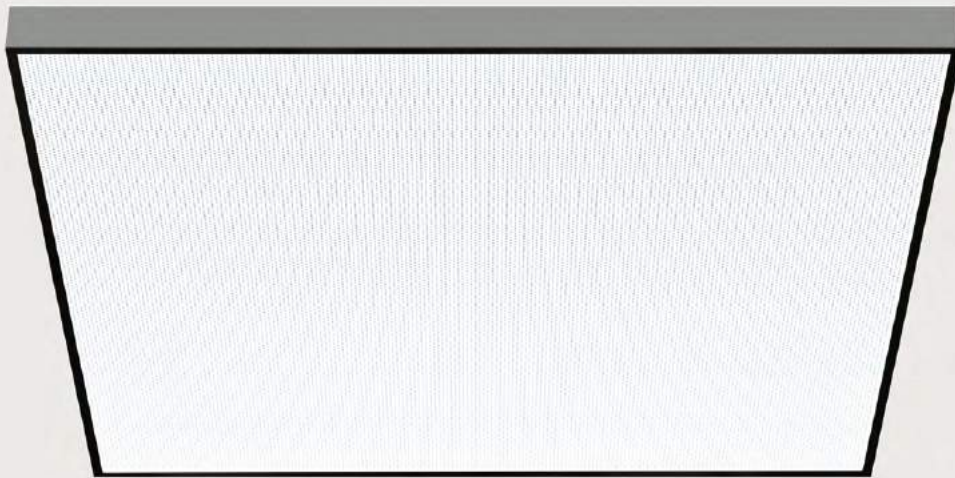

DE LED-Anbauleuchte für Wand- oder Deckenmontage. Rein direktstrahlend. Leuchtenkörper mit Bauhöhe 35mm aus Aluminiumprofil. Oberfläche natureloxiert oder weiß, graphit, schwarz bzw. champagnerfarben lackiert. Weitere Oberflächenoptionen siehe Lightnet-Surface-Collection oder RAL nach Wahl. Microprismenoptik mit optimierter Blendungsbegrenzung speziell für Office-Anwendungen. Satinierter Opaldiffusor für Allgemeinbeleuchtung mit max. Transmissionsgrad und homogener Lichtpunktauflösung. Konverter in Leuchtengehäuse integriert, wahlweise einfach schaltbar oder stufenlos dimmbar (DALI, Touch-Dim, Casambi). Farbtemperatur 2200K, 2700K, 3000K, 3500K, 4000K, 6500K oder Tunable White (2700-6500K). Binning initial \leq MacAdam 3. Farbwiedergabe CRI $>$ 80, CRI $>$ 90 oder Full Spectrum. Auf Anfrage: Integration von Notlichtkomponenten, Sensortechnologie.

EN LED surface-mounted luminaire for walls or ceilings. Direct only light distribution. Luminaire body made of aluminium profile with overall height of 35mm. Surface natural anodised or white, graphite, black or champagne coated. Further surface options see Lightnet-Surface-Collection or RAL of your choice. Microprismatic screen with optimized glare reduction especially for workplaces. Satin opal diffuser for general lighting with maximum transmittance and homogeneous lighting. Driver integrated into luminaire housing, optionally switchable or dimmable (DALI, Touch-Dim, Casambi). Colour temperature 2200K, 2700K, 3000K, 3500K, 4000K, 6500K or Tunable White (2700-6500K). Binning \leq MacAdam 3. Colour rendering CRI $>$ 80, CRI $>$ 90 or Full Spectrum. On request: Integration of emergency lighting components, sensor technology.

C A9 A B E-8 30 M-Q600

Product Family	C: Cubic
Type	A9: Direct only
Optical System	A: Microprismatic, O: Opal Diffuser
Surface Finish	W: Snow White, E: Silver Anodised, U: Urban Graphite, B: Jet Black, H: Anodic Champagne
Control Gear	E: On/Off, L: DALI, H: Touch-Dim, C: Casambi, 6: DALI DT6 for TW, 8: DALI DT8 for TW
Colour Rendering	8: CRI>80, 9: CRI>90, F: Full Spectrum [except 2200K]
Colour Temperature	22: 2200K, 27: 2700K, 30: 3000K, 35: 3500K, 40: 4000K, 65: 6500K, TW: Tunable White 2700-6500K [Q400-Q800]
Power	M: Medium Power, H: High Power
Size	Square size in mm: Q300, Q400, Q500, Q600, Q800
On Request	Emergency Module [Q400-Q800], Multisensor

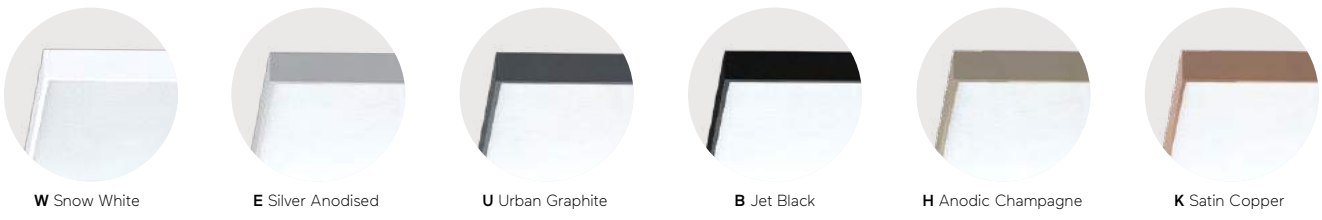
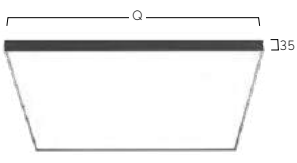
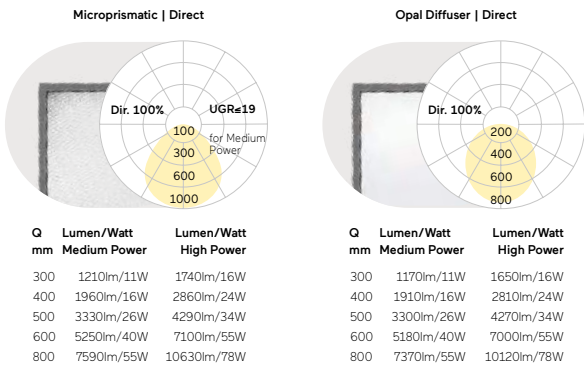

Cubic Max A2/X2 | Surface



DE LED-Anbauleuchte für Wand- oder Deckenmontage. Direktstrahlend mit indirekter Lichtkorona oder rein direktstrahlend. Leuchtenkörper mit Bauhöhe 55mm bzw. 75mm aus Aluminiumprofil. Oberfläche natureloxiert oder weiß, graphit, schwarz bzw. champagnerfarben lackiert. Weitere Oberflächenoptionen siehe Lightnet-Surface-Collection oder RAL nach Wahl. Microprismenoptik mit optimierter Blendungsbegrenzung speziell für Office-Anwendungen. Satinierter Opaldiffusor für Allgemeinbeleuchtung mit max. Transmissionsgrad und homogener Lichtpunktauflösung. Konverter in Leuchtgehäuse integriert, wahlweise einfach schaltbar oder stufenlos dimmbar (DALI, Touch-Dim, Casambi). Farbtemperatur 2200K, 2700K, 3000K, 3500K, 4000K, 6500K oder Tunable White (2700-6500K). Binning initial \leq MacAdam 3. Farbwiedergabe CRI $>$ 80, CRI $>$ 90 oder Full Spectrum. Auf Anfrage: Integration von Notlichtkomponenten, Sensortechnologie.

EN LED surface-mounted luminaire for walls or ceilings. Direct and indirect light distribution or direct only light distribution. Luminaire body made of aluminium profile with overall height of 55mm or 75mm. Surface natural anodised or white, graphite, black or champagne coated. Further surface options see Lightnet-Surface-Collection or RAL of your choice. Microprismatic screen with optimized glare reduction especially for workplaces. Satin opal diffuser for general lighting with maximum transmittance and homogeneous lighting. Driver integrated into luminaire housing, optionally switchable or dimmable (DALI, Touch-Dim, Casambi). Colour temperature 2200K, 2700K, 3000K, 3500K, 4000K, 6500K or Tunable White (2700-6500K). Binning \leq MacAdam 3. Colour rendering CRI $>$ 80, CRI $>$ 90 or Full Spectrum. On request: Integration of emergency lighting components, sensor technology.

C X2 A E E-8 30 M-Q330

- Product Family **C:** Cubic
- Type **A2:** Direct only, **X2:** Direct-Indirect
- Optical System **A:** Microprismatic, **O:** Opal Diffuser
- Surface Finish **W:** Snow White, **E:** Silver Anodised, **U:** Urban Graphite, **B:** Jet Black, **H:** Anodic Champagne, **K:** Satin Copper
- Control Gear **E:** On/Off, **L:** DALI, **H:** Touch-Dim, **C:** Casambi, **6:** DALI DT6 for TW, **8:** DALI DT8 for TW
- Colour Rendering **8:** CRI>80, **9:** CRI>90, **F:** Full Spectrum [except 2200K]
- Colour Temperature **22:** 2200K, **27:** 2700K, **30:** 3000K, **35:** 3500K, **40:** 4000K, **65:** 6500K, **TW:** Tunable White 2700-6500K [Q430-Q1200]
- Power **M:** Medium Power, **H:** High Power
- Size Square size in mm: **Q330, Q430, Q530, Q630, Q900, Q1200**
- On Request Emergency Module [Q430-Q1200], Radar Sensor



Cubic X2: Microprismatic | Direct-Indirect

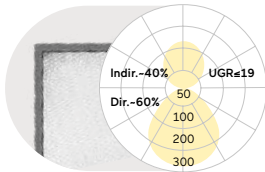

Q mm	Lumen/Watt Medium Power	Lumen/Watt High Power
330	2470lm/18W	3640lm/27W
430	4360lm/30W	6300lm/44W
530	6000lm/42W	11170lm/78W
630	9610lm/68W	14270lm/103W
900	11660lm/89W	18570lm/161W
1200	19310lm/152W	30990lm/273W

Cubic X2: Opal Diffuser | Direct-Indirect

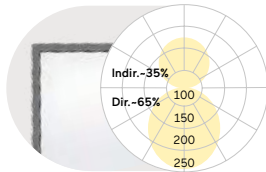

Q mm	Lumen/Watt Medium Power	Lumen/Watt High Power
330	2510lm/18W	3700lm/27W
430	4430lm/30W	6400lm/44W
530	6110lm/42W	11370lm/78W
630	9770lm/68W	14530lm/103W
900	11900lm/89W	18970lm/161W
1200	19730lm/152W	31700lm/273W

Cubic A2: Microprismatic | Direct

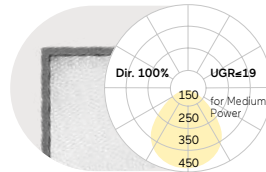

Q mm	Lumen/Watt Medium Power	Lumen/Watt High Power
330	1360lm/12W	2010lm/18W
430	2370lm/19W	3450lm/27W
530	3630lm/27W	6790lm/50W
630	5200lm/40W	8500lm/65W
900	7910lm/67W	13240lm/129W
1200	14100lm/122W	23550lm/228W

Cubic A2: Opal Diffuser | Direct

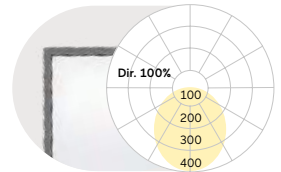

Q mm	Lumen/Watt Medium Power	Lumen/Watt High Power
330	1400lm/12W	2070lm/18W
430	2440lm/19W	3550lm/27W
530	3740lm/27W	6990lm/50W
630	5360lm/40W	8760lm/65W
900	8150lm/67W	13640lm/129W
1200	14520lm/122W	24260lm/228W

Lumen Values: Luminaire luminous flux at 4000K/CRI>80. Other configurations on request.

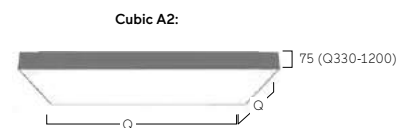
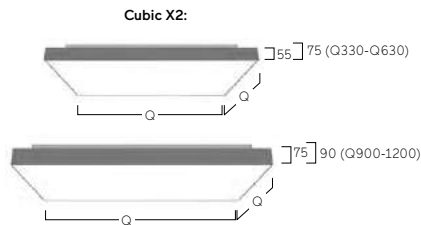

W Snow White

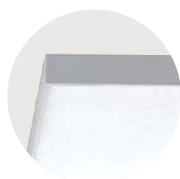

E Silver Anodised



U Urban Graphite



B Jet Black



H Anodic Champagne



K Satin Copper

Cubic Ambient A7 | Surface



DE LED-Anbauleuchte für Wand- oder Deckenmontage. Direkt-rundumstrahlend. Leuchtenkörper aus Aluminium. Oberfläche weiß, silber, graphit, schwarz bzw. champagnerfarben lackiert. Weitere Oberflächenoptionen siehe Lightnet-Surface-Collection oder RAL nach Wahl. Ambientdiffusor aus satiniertem Acrylglas für Allgemeinbeleuchtung mit max. Transmissionsgrad und homogener Lichtpunktauflösung. Konverter in Leuchtengehäuse integriert, wahlweise einfach schaltbar oder stufenlos dimmbar (DALI, Touch-Dim, Casambi). Farbtemperatur 2200K, 2700K, 3000K, 3500K, 4000K oder 6500K. Binning initial \leq MacAdam 3. Farbwiedergabe CRI $>$ 80 oder CRI $>$ 90. Auf Anfrage: Integration von Notlichtkomponenten.

EN LED surface-mounted luminaire for walls or ceilings. Omnidirectional light distribution. Luminaire body made of aluminium. Surface white, silver, graphite, black or champagne coated. Further surface options see Lightnet-Surface-Collection or RAL of your choice. Ambient diffuser made of frosted acrylic glass for general lighting with maximum transmittance and homogeneous lighting. Driver integrated into luminaire housing, optionally switchable or dimmable (DALI, Touch-Dim, Casambi). Colour temperature 2200K, 2700K, 3000K, 3500K, 4000K or 6500K. Binning \leq MacAdam 3. Colour rendering CRI $>$ 80 or CRI $>$ 90. On request: Integration of emergency lighting components.

C A7 F B E-8 30 M-Q300

- Product Family **C:** Cubic
- Type **A7:** Direct only
- Optical System **F:** Ambient
- Surface Finish **W:** Snow White, **S:** Radiant Silver, **U:** Urban Graphite, **B:** Jet Black, **H:** Anodic Champagne
- Control Gear **E:** On/Off, **L:** DALI, **H:** Touch-Dim, **C:** Casambi
- Colour Rendering **8:** CRI>80, **9:** CRI>90, **F:** Full Spectrum [except 2200K]
- Colour Temperature **22:** 2200K, **27:** 2700K, **30:** 3000K, **35:** 3500K, **40:** 4000K, **65:** 6500K
- Power **M:** Medium Power, **H:** High Power
- Size Square size in mm: **Q300, Q400, Q500, Q600**
- On Request Emergency Module [Q400-Q600], Radar Sensor



Ambient Diffuser | Direct

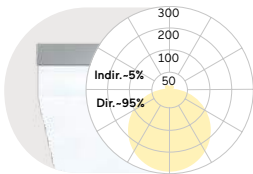

Q mm	Lumen/Watt Medium Power	Lumen/Watt High Power
300	1480lm/12W	2150lm/15W
400	2950lm/21W	3880lm/27W
500	4410lm/30W	6520lm/43W
600	5650lm/38W	8540lm/58W

Lumen Values: Luminaire luminous flux at 4000K/CRI>80. Other configurations on request.



W Snow White



S Radiant Silver



U Urban Graphite



B Jet Black



H Anodic Champagne

Cubic Déco A3 | Surface



DE LED-Anbauleuchte für Wand- oder Deckenmontage. Rein direktstrahlend. Leuchtenkörper aus Aluminiumprofil. Gehäuse-Außenfläche und dekorativer Reflektorring in unterschiedlichen Lackierungen und Kombinationen erhältlich, z.B. weiß, silber, graphit, schwarz, gold oder kupferfarben. Zu Oberflächenoptionen- und Kombinationen siehe Lightnet-Surface-Collection oder Bi-Colour-Auswahl. Rückversetzte Microprismenoptik mit optimierter Blendungsbegrenzung speziell für Office-Anwendungen. Satinierter Opaldiffusor für Allgemeinbeleuchtung mit max. Transmissionsgrad und homogener Lichtpunktauflösung. Konverter in Leuchtengehäuse integriert, wahlweise einfach schaltbar oder stufenlos dimmbar (DALI, Touch-Dim, Casambi). Farbtemperatur 2200K, 2700K, 3000K, 3500K, 4000K, 6500K oder Tunable White (2700-6500K). Binning initial \leq MacAdam 3. Farbwiedergabe CRI>80, CRI>90 oder Full Spectrum. Auf Anfrage: Integration von Notlichtkomponenten.

EN LED surface-mounted luminaire for walls or ceilings. Direct only light distribution. Luminaire body made of aluminum profile. Outer housing and Decorative reflector ring available in various finishes and combinations, e.g. white, silver, graphite, black, gold or copper coated. For further surface options see Lightnet-Surface-Collection or RAL of your choice. Recessed microprismatic screen with optimized glare reduction especially for workplaces. Satin opal diffuser for general lighting with maximum transmittance and homogeneous lighting. Driver integrated into luminaire housing, optionally switchable or dimmable (DALI, Touch-Dim, Casambi). Colour temperature 2200K, 2700K, 3000K, 3500K, 4000K, 6500K or Tunable White (2700-6500K). Binning \leq MacAdam 3. Colour rendering CRI>80, CRI>90 or Full Spectrum. On request: Integration of emergency lighting components.

C A3 A W E - 8 30 M - Q330 - G

- Product Family **C:** Cubic
- Type **A3:** Direct only
- Optical System **A:** Microprismatic, **O:** Opal Diffuser
- Surface Finish **W:** Snow White, **V:** Ivory White, **S:** Radiant Silver, **U:** Urban Graphite, **B:** Jet Black, **H:** Anodic Champagne, **K:** Satin Copper
- Control Gear **E:** On/Off, **L:** DALI, **H:** Touch-Dim, **C:** Casambi, **6:** DALI DT6 for TW, **8:** DALI DT8 for TW
- Colour Rendering **8:** CRI>80, **9:** CRI>90, **F:** Full Spectrum [except 2200K]
- Colour Temperature **22:** 2200K, **27:** 2700K, **30:** 3000K, **35:** 3500K, **40:** 4000K, **65:** 6500K, **TW:** Tunable White 2700-6500K [Q430-Q1200]
- Power **M:** Medium Power, **H:** High Power
- Size Square Size in mm: **Q330, Q430, Q530, Q630, Q900, Q1200**
- Reflector **W:** Snow White, **V:** Ivory White, **S:** Radiant Silver, **U:** Urban Graphite, **B:** Jet Black, **H:** Anodic Champagne, **K:** Satin Copper, **G:** Satin Gold
- On Request Emergency Module [Q430-Q1200], Radar Sensor



Microprismatic | Direct

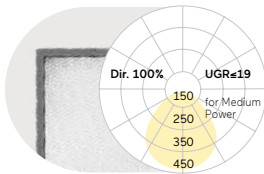

Opal Diffuser | Direct

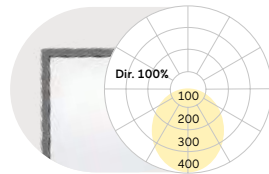

Q mm	Lumen/Watt Medium Power	Lumen/Watt High Power	Q mm	Lumen/Watt Medium Power	Lumen/Watt High Power
330	1360lm/12W	2010lm/18W	330	1400lm/12W	2070lm/18W
430	2370lm/19W	3450lm/27W	430	2440lm/19W	3550lm/27W
530	3630lm/27W	6790lm/50W	530	3740lm/27W	6990lm/50W
630	5200lm/40W	8500lm/65W	630	5360lm/40W	8760lm/65W
900	7910lm/67W	13240lm/129W	900	8150lm/67W	13640lm/129W
1200	14100lm/122W	23550lm/228W	1200	14520lm/122W	24260lm/228W

Lumen Values: Luminaire luminous flux at 4000K/CRI>80. Other configurations on request.

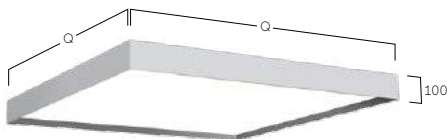

W Snow White
W Snow White

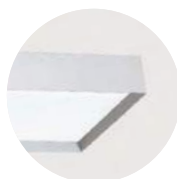

W Snow White
S Radiant Silver



W Snow White
B Jet Black



W Snow White
G Satin Gold

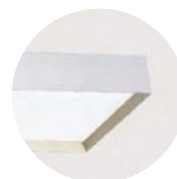

W Snow White
H Anodic Champagne

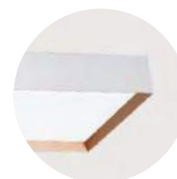

W Snow White
K Satin Copper

Matric Déco A9 | Surface

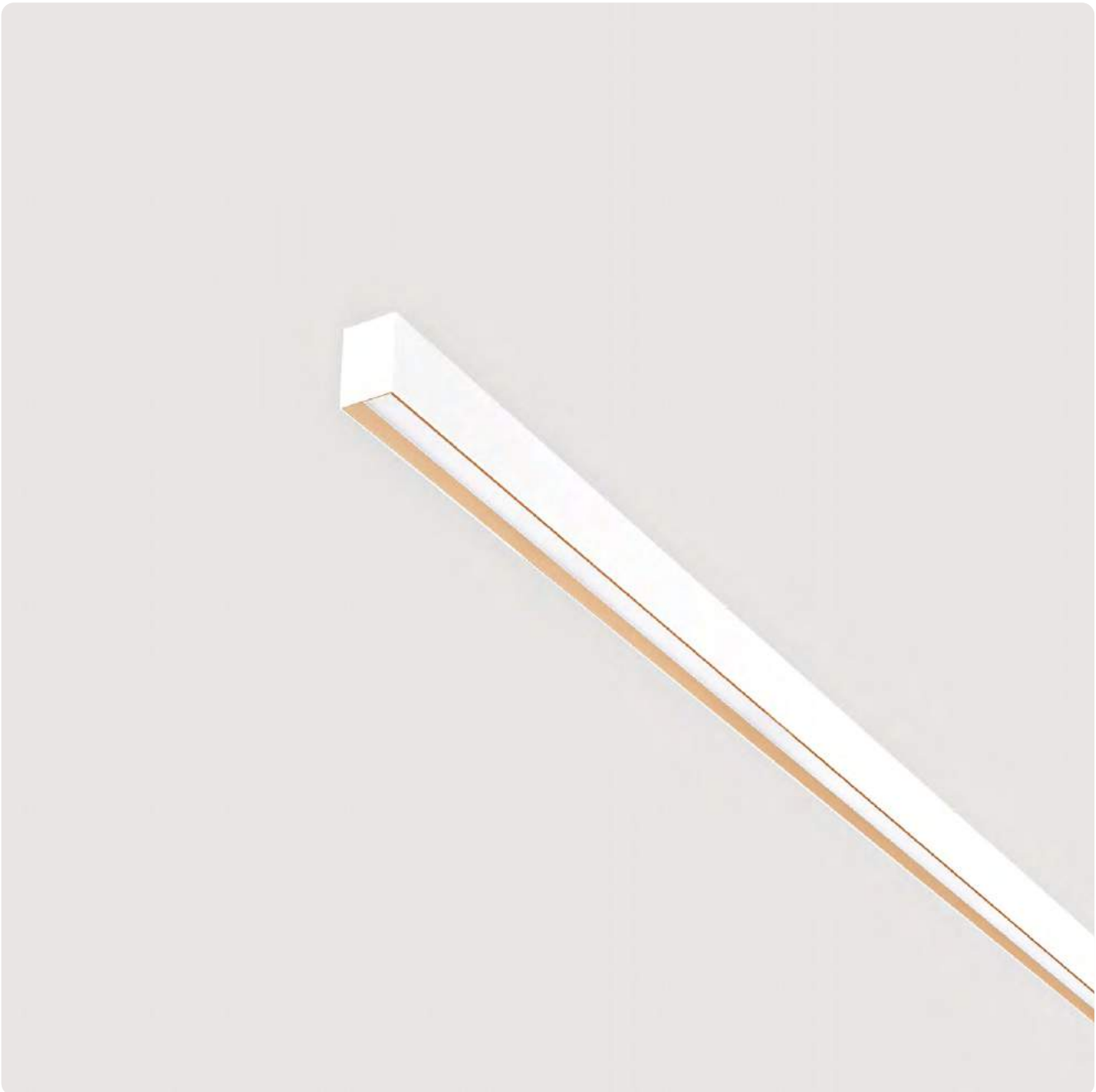

DE LED-Anbauleuchte für Wand- oder Deckenmontage. Rein direktstrahlend. Lichtkanal aus Aluminiumprofil mit 55mm Profillbreite. Millimetergenaue Längenfertigung nach Vorgabe möglich. Rückversetzte Optik für bessere Blendungsbegrenzung und dekorative Lichtwirkung. Gehäuse-Außenfläche und rundum laufender Reflektorring in unterschiedlichen Lackierungen und Kombinationen erhältlich. Oberflächenoptionen siehe Lightnet-Surface-Collection oder RAL nach Wahl. Direktanteil über Präzisionslinsen mit Abblenderaster für breite rotationssymmetrische Lichtstärkeverteilung bei gleichzeitig hoher Blendungsbegrenzung (UGR<19) für Office Anwendungen. Abblenderaster in verschiedenen Farbkombinationen erhältlich. Microprismenoptik aus Spezialacrylglas mit optimierter Blendungsbegrenzung für Office-Anwendungen. Satinierter Opaldiffusor für Allgemeinbeleuchtung mit max. Transmissionsgrad und homogener Lichtpunktauflösung. Konverter in Leuchtgehäuse integriert, wahlweise einfach schaltbar oder stufenlos dimmbar (DALI, Touch-Dim, Casambi). Farbtemperatur 2200K, 2700K, 3000K, 3500K, 4000K, 6500K oder Tunable White (2700-6500K). Binning initial \leq MacAdam 3. Farbwiedergabe CRI>80, CRI>90 oder Full Spectrum. Auf Anfrage: Integration von Stromschienen und Strahlern, Notlichtkomponenten, Sensortechnologie sowie Vielzahl weiterer Optionen.

EN LED surface-mounted luminaire for walls or ceilings. Direct only light distribution. Light channel made of 55mm wide aluminium profile. Bespoke lengths possible. Recessed screen with optimized glare reduction and decorative lighting impact. Outer housing and all-around reflector ring available in various finishes and combinations. Further surface options see Lightnet-Surface-Collection or RAL of your choice. Direct light using precision lenses with louvre for wide uniform symmetrical light distribution with high glare limitation (UGR<19) especially for workplaces. Louvre available in various colour finishes. Microprismatic screen made of special acrylic glass with optimized glare reduction especially for workplaces. Satin opal diffuser for general lighting with maximum transmittance and homogeneous lighting. Driver integrated into luminaire housing, optionally switchable or dimmable (DALI, Touch-Dim, Casambi). Colour temperature 2200K, 2700K, 3000K, 3500K, 4000K, 6500K or Tunable White (2700-6500K). Binning \leq MacAdam 3. Colour rendering CRI>80, CRI>90 or Full Spectrum. On request: Integration of tracks and spotlights, emergency lighting components, sensor technology and many other options.

L A9LWE - 8 30 E - L1209-B*

- Product Family **L:** Matric
- Type **A9:** Direct only
- Optical System **A:** Microprismatic, **O:** Opal Diffuser, **L:** Lens Louvre*
- Surface Finish **W:** Snow White, **V:** Ivory White, **A:** Satin Silver, **E:** Silver Anodised,
U: Urban Graphite, **B:** Jet Black, **H:** Anodic Champagne, **K:** Satin Copper
- Control Gear **E:** On/Off, **L:** DALI, **H:** Touch-Dim, **C:** Casambi [L890-L2055], **6:** DALI DT6 for TW [L1182-L2055], **8:** DALI DT8 for TW [L890-L2055]
- Colour Rendering **8:** CRI>80, **9:** CRI>90, **F:** Full Spectrum [except 2200K]
- Colour Temperature **22:** 2200K, **27:** 2700K, **30:** 3000K, **35:** 3500K, **40:** 4000K, **65:** 6500K, **TW:** Tunable White 2700-6500K
- Power **E:** Low Power, **M:** Medium Power, **H:** High Power
- Size Luminaire Length in mm (Microprismatic, Opal Diffuser): **L600, L890, L1182, L1475, L1765, L2055**
Luminaire Length in mm (Lens Louvre*): **L681, L945, L1209, L1474, L1738, L2002**
- Lens Louvre* **W:** Snow White, **V:** Ivory White, **A:** Satin Silver, **U:** Urban Graphite, **B:** Jet Black, **H:** Anodic Champagne, **K:** Satin Copper, **G:** Satin Gold
- On Request Emergency Module [L1182-L2055]

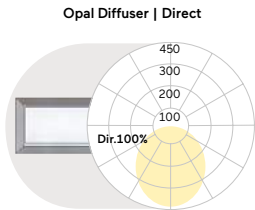
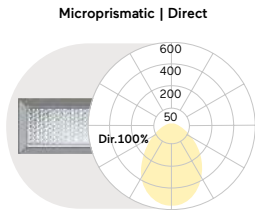
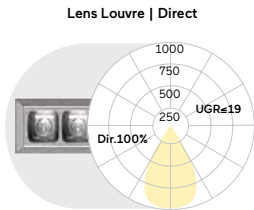

L mm	Lumen/Watt Low Power	Lumen/Watt High Power
681	1090lm/10W	2000lm/17W
945	1520lm/13W	2790lm/24W
1209	1960lm/16W	3590lm/30W
1474	2390lm/19W	4390lm/37W
1738	2830lm/23W	5190lm/43W
2002	3260lm/26W	5990lm/49W

L mm	Lumen/Watt Low Power	Lumen/Watt High Power
600	550lm/7W	990lm/12W
890	830lm/10W	1490lm/16W
1182	1110lm/12W	1990lm/21W
1475	1390lm/14W	2480lm/25W
1765	1660lm/17W	2980lm/30W
2055	1940lm/22W	3480lm/37W

L mm	Lumen/Watt Medium Power	Lumen/Watt High Power
600	780lm/9W	1060lm/12W
890	1170lm/12W	1590lm/16W
1182	1560lm/15W	2110lm/21W
1475	1950lm/19W	2640lm/25W
1765	2330lm/22W	3170lm/30W
2055	2720lm/28W	3700lm/37W

Lumen Values: Luminaire luminous flux at 4000K/CRI>80. Other configurations on request.

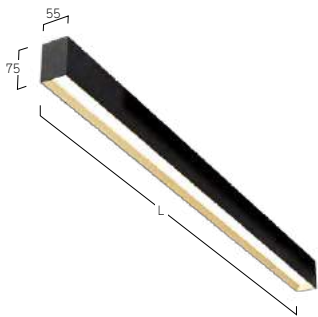

W Snow White
W Snow White



A Satin Silver
W Snow White



A Satin Silver
B Jet Black



B Jet Black
G Satin Gold



B Jet Black
H Anodic Champagne



W Snow White
K Satin Copper



W Snow White
W Snow White

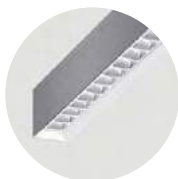

A Satin Silver
W Snow White



B Jet Black
A Satin Silver



B Jet Black
B Jet Black

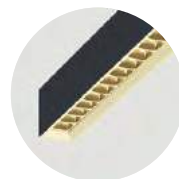

B Jet Black
G Satin Gold



W Snow White
K Satin Copper

Matric AY | System 40mm Surface

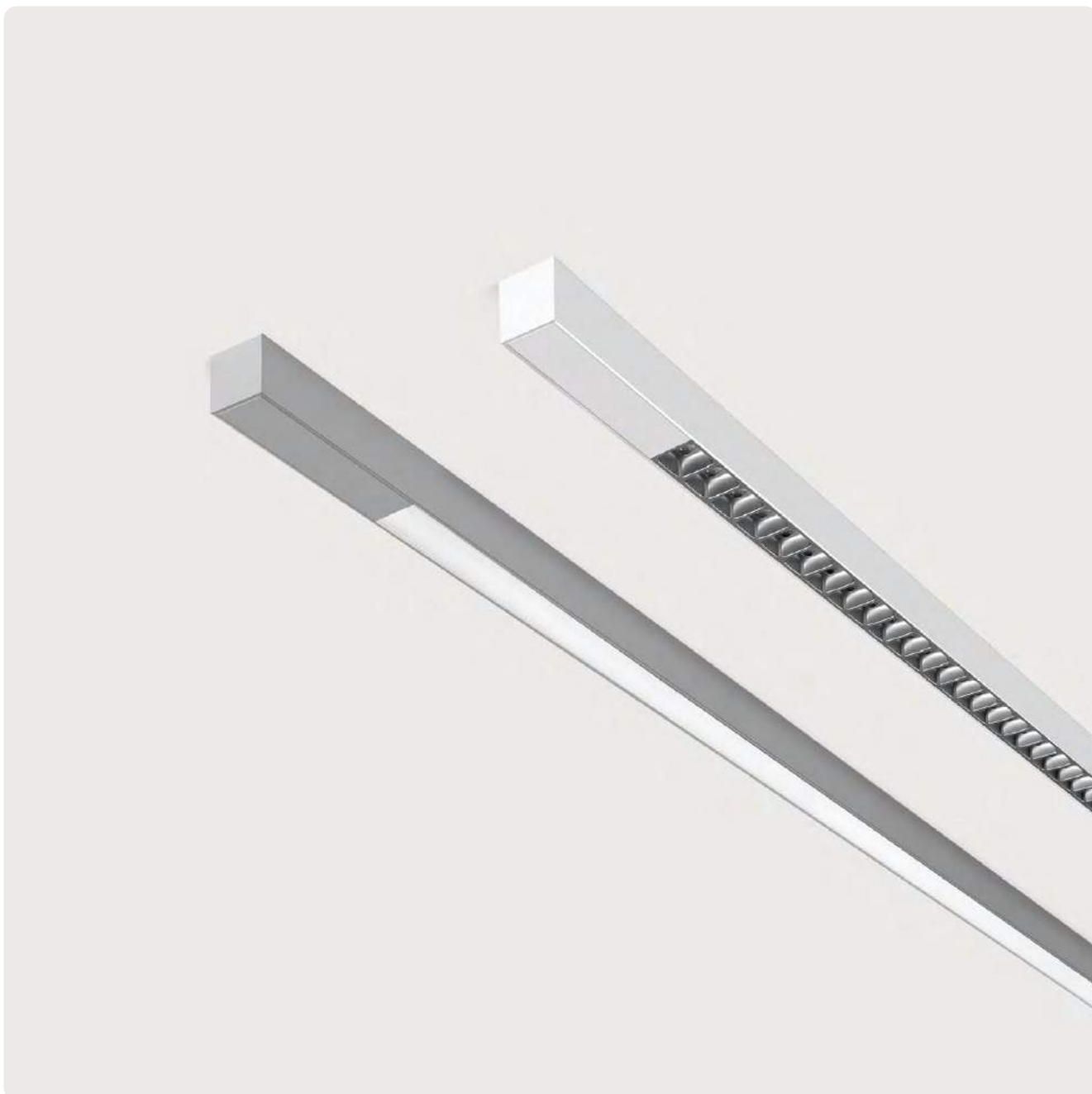

DE LED-Anbauleuchte für Wand- oder Deckenmontage. Rein direktstrahlend. Leuchtenkörper aus Aluminiumprofil mit 40x40mm Querschnitt. Millimetergenaue Längenfertigung nach Vorgabe möglich. Oberfläche natureloxiert oder weiß, graphit, schwarz, champagner oder kupferfarben lackiert. Weitere Oberflächenoptionen siehe Lightnet-Surface-Collection oder RAL nach Wahl. Direktanteil über Präzisionslinsen mit Abblenderaster für breite rotationssymmetrische Lichtstärkeverteilung bei gleichzeitig hoher Blendungsbegrenzung (UGR<19) für Office Anwendungen. Abblenderaster in verschiedenen Farbkombinationen erhältlich. Alternativ Microprismenoptik aus Spezialacrylglas mit optimierter Blendungsbegrenzung für Office-Anwendungen. Konverter hinter Blindfeldern in Leuchtengehäuse integriert, wahlweise einfach schaltbar oder stufenlos dimmbar (DALI, Touch-Dim, Casambi). Farbtemperatur 2700K, 3000K, 3500K, 4000K, 6500K. Binning initial \leq MacAdam 3. Farbwiedergabe CRI>80, CRI>90 oder Full Spectrum. Auf Anfrage: Integration von Notlichtkomponenten und Sensortechnologie (bei Verlängerung der Blindfelder).

EN LED surface-mounted luminaire for walls or ceilings. Direct only light distribution. Luminaire body made of aluminium profile with 40x40mm cross-section. Bespoke lengths possible. Surface natural anodised or white, graphite, black, champagne or copper coated. Further surface options see Lightnet-Surface-Collection or RAL of your choice. Direct light using precision lenses with louvre for wide uniform symmetrical light distribution with high glare limitation (UGR<19) especially for workplaces. Louvre available in various colour finishes. Alternatively, microprismatic screen made of special acrylic glass with optimized glare reduction especially for workplaces. Driver integrated into luminaire housing behind blind bays, optionally switchable or dimmable (DALI, Touch-Dim, Casambi). Colour temperature 2700K, 3000K, 3500K, 4000K or 6500K. Binning \leq MacAdam 3. Colour rendering CRI>80, CRI>90 or Full Spectrum. On request: Integration of emergency lighting components and sensor technology.

LAYLWE - 830 M - L1592 - B*

Product Family	L: Matric
Type	AY: Direct only
Optical System	A: Microprismatic, O: Opal Diffuser, L: Lens Louvre*
Surface Finish	W: Snow White, V: Ivory White, A: Satin Silver, S: Radiant Silver, U: Urban Graphite, B: Jet Black, H: Anodic Champagne, K: Satin Copper
Control Gear	E: On/Off, L: DALI, H: Touch-Dim, C: Casambi
Colour Rendering	8: CRI>80, 9: CRI>90, F: Full Spectrum [except 2200K]
Colour Temperature	22: 2200K, 27: 2700K, 30: 3000K, 35: 3500K, 40: 4000K, 65: 6500K
Power	M: Medium Power, H: High Power
Size	Luminaire Length in mm (Lens Louvre): L1592, L1857 Luminaire Length in mm (Opal Diffuser, Microprismatic) : L1592, L1894
Lens Louvre*	W: Snow White, A: Satin Silver, B: Jet Black, H: Anodic Champagne, K: Satin Copper, G: Satin Gold



Lens Louvre | Direct

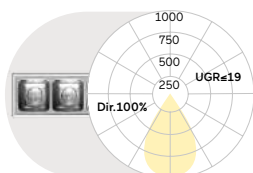

L mm	Lumen/Watt Medium Power	Lumen/Watt High Power
1592	1590lm/13W	2190lm/18W
1857	1990lm/16W	2730lm/22W

Microprismatic | Direct

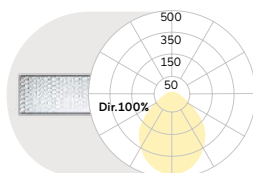

L mm	Lumen/Watt Medium Power	Lumen/Watt High Power
1592	1840lm/18W	2540lm/24W
1894	2340lm/22W	3230lm/30W

Opal Diffuser | Direct

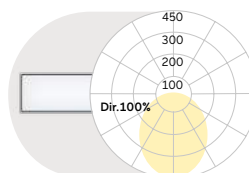

L mm	Lumen/Watt Medium Power	Lumen/Watt High Power
1592	1970lm/18W	2710lm/24W
1894	2500lm/22W	3450lm/30W

Lumen Values: Luminaire luminous flux at 4000K/CRI>80. Other configurations on request.



W Snow White
A Satin Silver



A Satin Silver
A Satin Silver



W Snow White
B Jet Black



B Jet Black
H Anodic Champagne



B Jet Black
G Satin Gold



V Ivory White
H Anodic Champagne

Matric XY | System 40mm Surface

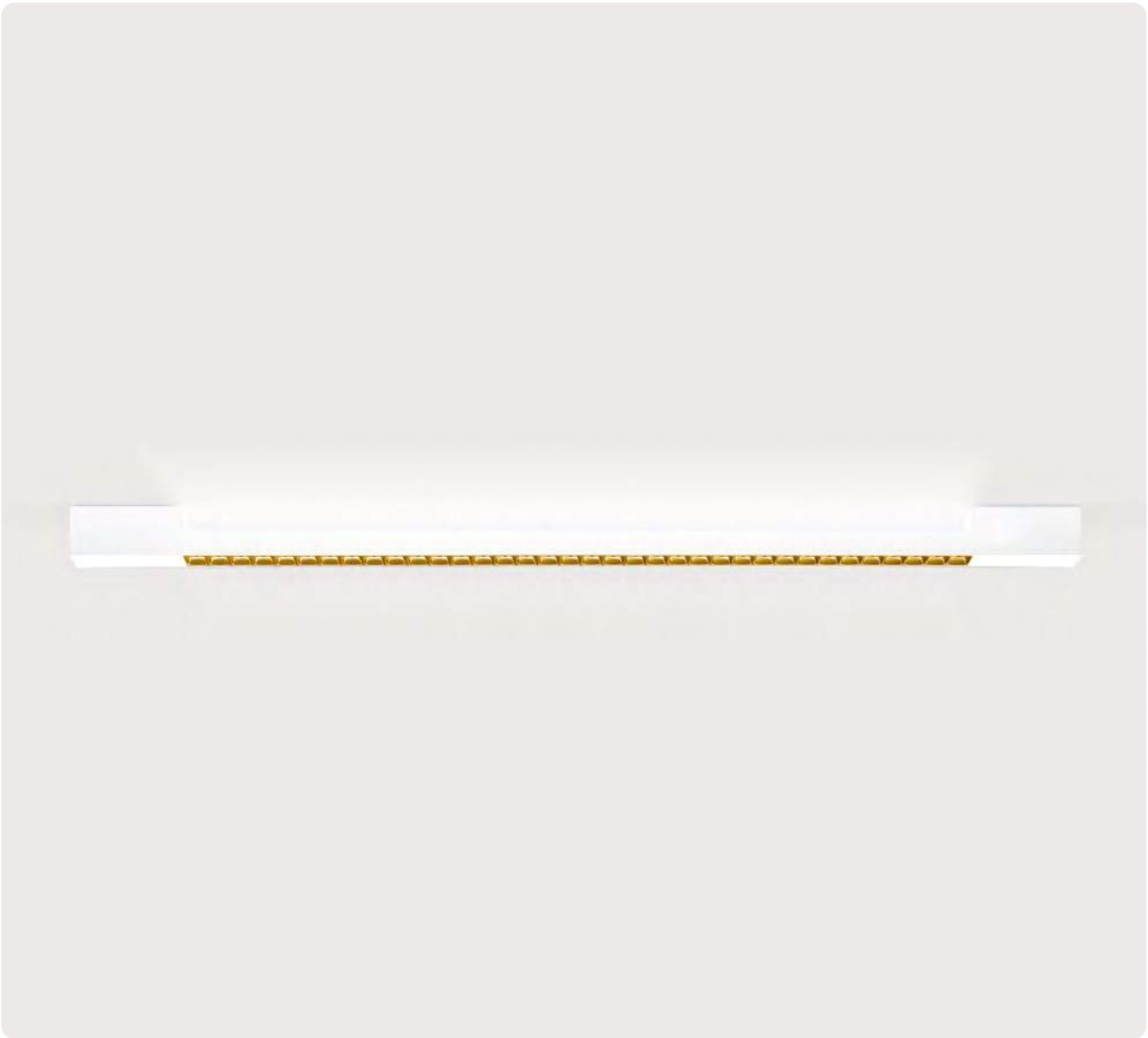

DE LED-Anbauleuchte für Wand- oder Deckenmontage. Direktstrahlend mit indirekter Lichtkorona. Leuchtenkörper aus Aluminiumprofil mit 40x40mm Querschnitt und stirnseitigen oder zentralen Distanzelementen. Millimetergenaue Längenfertigung nach Vorgabe mit Einschränkungen möglich. Oberfläche natureloxiert oder weiß, graphit, schwarz, champagner oder kupferfarben lackiert. Weitere Oberflächenoptionen siehe Lightnet-Surface-Collection oder RAL nach Wahl. Direktanteil über Präzisionslinsen mit Abblenderaster für breite rotationssymmetrische Lichtstärkeverteilung bei gleichzeitig hoher Blendungsbegrenzung (UGR<19) für Office Anwendungen. Abblenderaster in verschiedenen Farbkombinationen erhältlich. Alternativ Microprismenoptik aus Spezialacrylglas mit optimierter Blendungsbegrenzung für Office-Anwendungen. Konverter hinter Blindfeldern in Leuchtgehäuse integriert, wahlweise einfach schaltbar oder stufenlos dimmbar (DALI, Touch-Dim, Casambi). Farbtemperatur 2700K, 3000K, 3500K, 4000K, 6500K. Binning initial \leq MacAdam 3. Farbwiedergabe CRI>80, CRI>90 oder Full Spectrum.

EN LED surface-mounted luminaire for walls or ceilings. Direct and indirect light distribution. Luminaire body made aluminium profile with 40x40mm cross-section and frontal or central spacers. Bespoke lengths available with some limitations. Surface natural anodised or white, graphite, black, champagne or copper coated. Further surface options see Lightnet-Surface-Collection or RAL of your choice. Direct light using precision lenses with louvre for wide uniform symmetrical light distribution with high glare limitation (UGR<19) especially for workplaces. Louvre available in various colour finishes. Alternatively, microprismatic screen made of special acrylic glass with optimized glare reduction especially for workplaces. Driver integrated into luminaire housing behind blind bays, optionally switchable or dimmable (DALI, Touch-Dim, Casambi). Colour temperature 2700K, 3000K, 3500K, 4000K or 6500K. Binning \leq MacAdam 3. Colour rendering CRI>80, CRI>90 or Full Spectrum.

LXYLWE - 830M - L1514-B*

- Product Family **L:** Matric
- Type **XY:** Direct-Indirect
- Optical System **A:** Microprismatic, **O:** Opal Diffuser, **L:** Lens Louvre*
- Surface Finish **W:** Snow White, **V:** Ivory White, **A:** Satin Silver, **S:** Radiant Silver,
U: Urban Graphite, **B:** Jet Black, **H:** Anodic Champagne, **K:** Satin Copper
- Control Gear **E:** On/Off, **L:** DALI, **H:** Touch-Dim
- Colour Rendering **8:** CRI>80, **9:** CRI>90, **F:** Full Spectrum [except 2200K]
- Colour Temperature **22:** 2200K, **27:** 2700K, **30:** 3000K, **35:** 3500K, **40:** 4000K, **65:** 6500K
- Power **M:** Medium Power, **H:** High Power
- Size Luminaire Length in mm (Lens Louvre): **L1250, L1514, L2150**
Luminaire Length in mm (Opal Diffuser, Microprismatic) : **L1200, L1490, L2150**
- Lens Louvre* **W:** Snow White, **A:** Satin Silver, **B:** Jet Black, **H:** Anodic Champagne, **K:** Satin Copper, **G:** Satin Gold

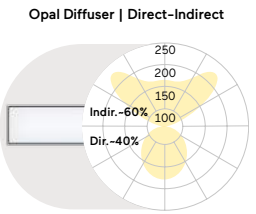
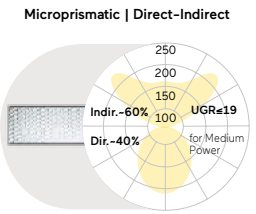
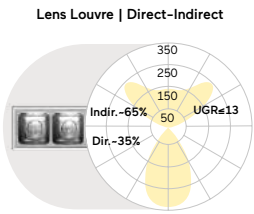

L mm	Lumen/Watt Medium Power	Lumen/Watt High Power
1250	4140lm/33W	4660lm/37W
1514	5460lm/41W	6130lm/47W
2150	7270lm/55W	8170lm/63W

L mm	Lumen/Watt Medium Power	Lumen/Watt High Power
1200	4250lm/35W	4830lm/41W
1490	5680lm/46W	6440lm/53W
2150	7570lm/63W	8580lm/74W

L mm	Lumen/Watt Medium Power	Lumen/Watt High Power
1200	4360lm/35W	4970lm/41W
1490	5820lm/46W	6630lm/53W
2150	7750lm/63W	8840lm/74W

Lumen Values: Luminaire luminous flux at 4000K/CRI>80. Other configurations on request.

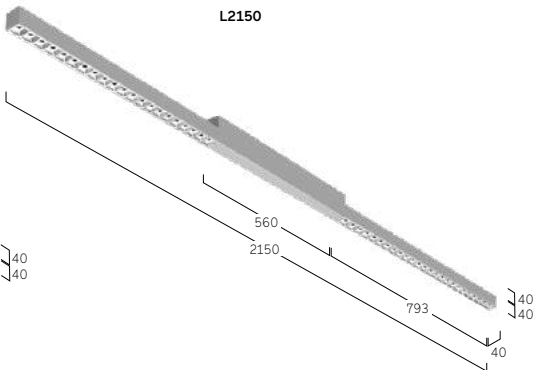
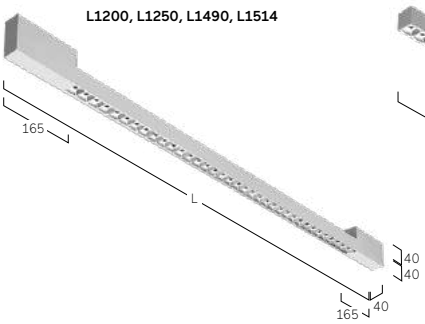

Matric Surface





Oxford Properties, Berlin, Germany
Matric A1

Matric Surface



Kindergarten, Grünenplan, Germany
Matric A1
Photography: Frank Ausseker





Matric Surface

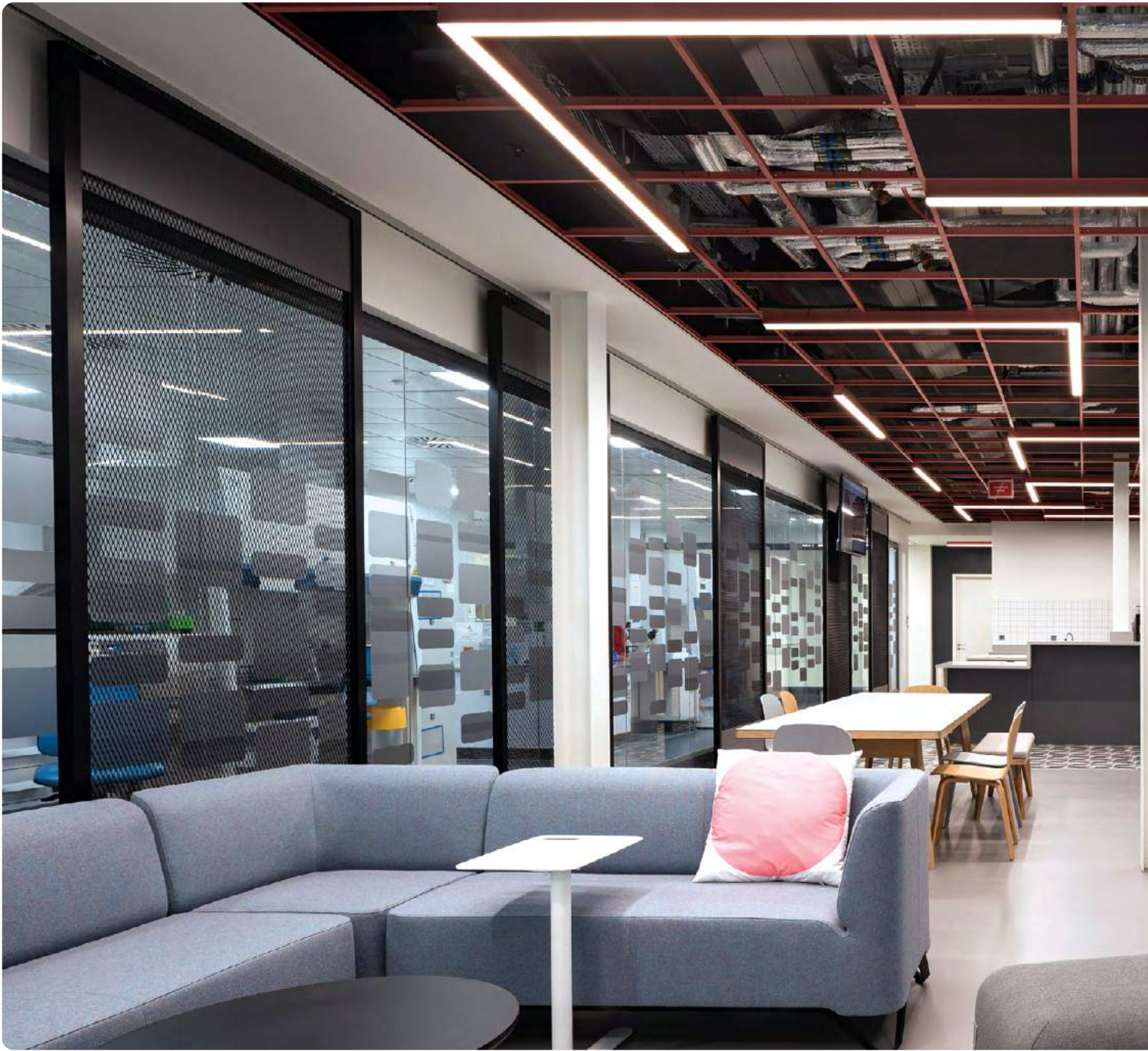



Life Science Office, Dublin, Ireland
Matric A3
Photography: Donal Murphy Photography
Planning: dlight

Matric AX | System 40mm Surface

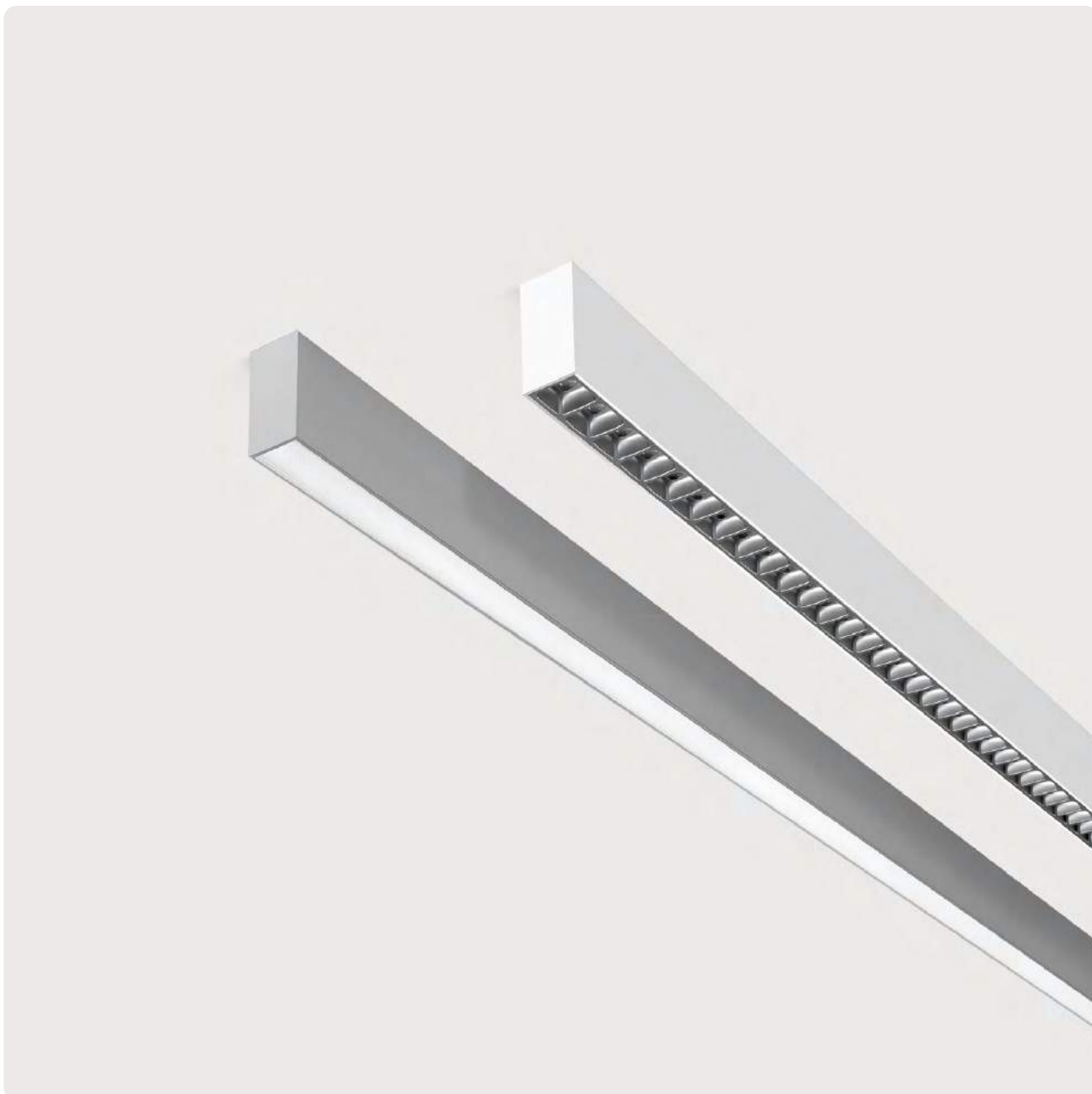

DE LED-Anbauleuchte für Wand- oder Deckenmontage. Rein direktstrahlend. Lichtkanal aus Aluminiumprofil mit 40mm Profildbreite. Millimetergenaue Längenfertigung nach Vorgabe möglich. Oberfläche natureloxiert oder weiß, graphit, schwarz, champagner oder kupferfarben lackiert. Weitere Oberflächenoptionen siehe Lightnet-Surface-Collection oder RAL nach Wahl. Direktanteil über Präzisionslinsen mit Ablendraster für breite rotationssymmetrische Lichtstärkeverteilung bei gleichzeitig hoher Blendungsbegrenzung ($UGR < 19$) für Office Anwendungen. Ablendraster in verschiedenen Farbkombinationen erhältlich. Microprismenoptik aus Spezialacrylglas mit optimierter Blendungsbegrenzung für Office-Anwendungen. Satiniertes Opaldiffusor für Allgemeinbeleuchtung mit max. Transmissionsgrad und homogener Lichtpunktauflösung. Wallwasher für homogene Beleuchtung vertikaler Flächen. Konverter in Leuchtgehäuse integriert, wahlweise einfach schaltbar oder stufenlos dimmbar (DALI, Touch-Dim, Casambi). Farbtemperatur 2200K, 2700K, 3000K, 3500K, 4000K, 6500K oder Tunable White (2700-6500K). Binning initial \leq MacAdam 3. Farbwiedergabe $CRI > 80$, $CRI > 90$ oder Full Spectrum. Auf Anfrage: Integration von Stromschienen und Strahlern, Notlichtkomponenten, Sensortechnologie.

EN LED surface-mounted luminaire for walls or ceilings. Direct only light distribution. Light channel made of 40mm wide aluminium profile. Bespoke lengths possible. Surface natural anodised or white, graphite, black, champagne or copper coated. Further surface options see Lightnet-Surface-Collection or RAL of your choice. Direct light using precision lenses with louvre for wide uniform symmetrical light distribution with high glare limitation ($UGR < 19$) especially for workplaces. Louvre available in various colour finishes. Microprismatic screen made of special acrylic glass with optimized glare reduction especially for workplaces. Satin opal diffuser for general lighting with maximum transmittance and homogeneous lighting. Wallwasher for homogeneous illumination of vertical surfaces. Driver integrated into luminaire housing, optionally switchable or dimmable (DALI, Touch-Dim, Casambi). Colour temperature 2200K, 2700K, 3000K, 3500K, 4000K, 6500K or Tunable White (2700-6500K). Binning \leq MacAdam 3. Colour rendering $CRI > 80$, $CRI > 90$ or Full Spectrum. On request: Integration of tracks and spotlights, emergency lighting components, sensor technology.

L AXLWE - 830E - L1194 - B*

- Product Family **L:** Matric
- Type **AX:** Direct only
- Optical System **A:** Microprismatic, **O:** Opal Diffuser, **G:** Wallwasher, **F:** Ambient, **L:** Lens Louvre*
- Surface Finish **W:** Snow White, **V:** Ivory White, **A:** Satin Silver, **E:** Silver Anodised,
U: Urban Graphite, **B:** Jet Black, **H:** Anodic Champagne, **K:** Satin Copper
- Control Gear **E:** On/Off, **L:** DALI, **H:** Touch-Dim, **C:** Casambi [L890-L2055], **6:** DALI DT6 for TW [L1182-L2055], **8:** DALI DT8 for TW [L890-L2055]
- Colour Rendering **8:** CRI>80, **9:** CRI>90, **F:** Full Spectrum [except 2200K]
- Colour Temperature **22:** 2200K, **27:** 2700K, **30:** 3000K, **35:** 3500K, **40:** 4000K, **65:** 6500K, **TW:** Tunable White 2700-6500K
- Power **E:** Low Power, **M:** Medium Power, **H:** High Power
- Size Luminaire Length in mm (Microprismatic, Opal Diffuser, Wallwasher, Ambient): **L600, L890, L1182, L1475, L1765, L2055**
Luminaire Length in mm (Lens Louvre*): **L665, L930, L1194, L1458, L1723, L1987**
- Lens Louvre* **W:** Snow White, **A:** Satin Silver, **B:** Jet Black, **H:** Anodic Champagne, **K:** Satin Copper, **G:** Satin Gold
- On Request 90°Corner, Midpin Downlight XD, Midpin Spotlights XM, Midpin Spotlights XP, 3-Phase Track, Multisensor [L1182-L2055], Emergency Module [L1182-L2055]



Lens Louvre Direct			Microprismatic Direct			Opal Diffuser Direct			Wallwasher Direct		
L mm	Lumen/Watt Low Power	Lumen/Watt High Power	L mm	Lumen/Watt Low Power	Lumen/Watt High Power	L mm	Lumen/Watt Medium Power	Lumen/Watt High Power	L mm	Lumen/Watt Medium Power	Lumen/Watt High Power
665	1090lm/10W	2000lm/17W	600	610lm/7W	1100lm/12W	600	870lm/9W	1180lm/12W	600	840lm/11W	1070lm/14W
930	1520lm/13W	2790lm/24W	890	920lm/10W	1650lm/16W	890	1300lm/12W	1760lm/16W	890	1260lm/15W	1610lm/19W
1194	1960lm/16W	3590lm/30W	1182	1230lm/12W	2200lm/21W	1182	1730lm/15W	2350lm/21W	1182	1680lm/19W	2150lm/25W
1458	2390lm/19W	4390lm/37W	1475	1530lm/14W	2750lm/25W	1475	2160lm/19W	2940lm/25W	1475	2100lm/23W	2680lm/30W
1723	2830lm/23W	5190lm/43W	1765	1840lm/17W	3300lm/30W	1765	2600lm/22W	3530lm/30W	1765	2520lm/28W	3220lm/36W
1987	3260lm/26W	5990lm/49W	2055	2150lm/22W	3850lm/37W	2055	3030lm/28W	4110lm/37W	2055	2940lm/34W	3760lm/44W

Lumen Values: Luminaire luminous flux at 4000K/CRI>80. Other configurations on request.

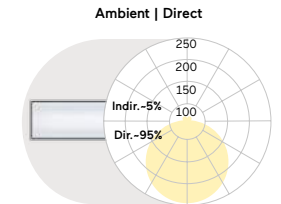

Lens Louvre Microprismatic Opal Diffuser Wallwasher			Ambient		
L mm	Lumen/Watt Medium Power	Lumen/Watt High Power	L mm	Lumen/Watt Medium Power	Lumen/Watt High Power
600	1080lm/9W	1460lm/12W	600	1620lm/12W	2190lm/16W
890	1620lm/12W	2190lm/16W	1182	2150lm/16W	2910lm/21W
1182	2150lm/16W	2910lm/21W	1475	2690lm/19W	3640lm/26W
1475	2690lm/19W	3640lm/26W	1765	3230lm/22W	4370lm/30W
1765	3230lm/22W	4370lm/30W	2055	3770lm/28W	5100lm/37W



Matric A3 | System 55mm Surface



DE LED-Anbauleuchte für Wand- oder Deckenmontage. Rein direktstrahlend. Lichtkanal aus Aluminiumprofil mit 55mm Profilbreite. Millimetergenaue Längenfertigung nach Vorgabe möglich. Oberfläche natureloxiert oder weiß, graphit, schwarz, champagner oder kupferfarben lackiert. Weitere Oberflächenoptionen siehe Lightnet-Surface-Collection oder RAL nach Wahl. Direktanteil über Präzisionslinsen mit Abblendraster für breite rotationssymmetrische Lichtstärkeverteilung bei gleichzeitig hoher Blendungsbegrenzung ($UGR < 19$) für Office Anwendungen. Abblendraster in verschiedenen Farbkombinationen erhältlich. Microprismenoptik aus Spezialacrylglas mit optimierter Blendungsbegrenzung für Office-Anwendungen. Satiniertes Opaldiffusor für Allgemeinbeleuchtung mit max. Transmissionsgrad und homogener Lichtpunktauflösung. Wallwasher für homogene Beleuchtung vertikaler Flächen. Konverter in Leuchtgehäuse integriert, wahlweise einfach schaltbar oder stufenlos dimmbar (DALI, Touch-Dim, Casambi). Farbtemperatur 2200K, 2700K, 3000K, 3500K, 4000K, 6500K oder Tunable White (2700-6500K). Binning initial \leq MacAdam 3. Farbwiedergabe $CRI > 80$, $CRI > 90$ oder Full Spectrum. Auf Anfrage: Integration von Stromschienen und Strahlern, Notlichtkomponenten, Sensortechnologie.

EN LED surface-mounted luminaire for walls or ceilings. Direct only light distribution. Light channel made of 55mm wide aluminium profile. Bespoke lengths possible. Surface natural anodised or white, graphite, black, champagne or copper coated. Further surface options see Lightnet-Surface-Collection or RAL of your choice. Direct light using precision lenses with louvre for wide uniform symmetrical light distribution with high glare limitation ($UGR < 19$) especially for workplaces. Louvre available in various colour finishes. Microprismatic screen made of special acrylic glass with optimized glare reduction especially for workplaces. Satin opal diffuser for general lighting with maximum transmittance and homogeneous lighting. Wallwasher for homogeneous illumination of vertical surfaces. Driver integrated into luminaire housing, optionally switchable or dimmable (DALI, Touch-Dim, Casambi). Colour temperature 2200K, 2700K, 3000K, 3500K, 4000K, 6500K or Tunable White (2700-6500K). Binning \leq MacAdam 3. Colour rendering $CRI > 80$, $CRI > 90$ or Full Spectrum. On request: Integration of tracks and spotlights, emergency lighting components, sensor technology.

LA3LWE-830E-L1252-B*

Product Family	L: Matric
Type	A3: Direct only
Optical System	A: Microprismatic, O: Opal Diffuser, G: Wallwasher, L: Lens Louvre*, D: Opal Diffuser (Polycarbonate)**
Surface Finish	W: Snow White, V: Ivory White, E: Silver Anodised, U: Urban Graphite, B: Jet Black, H: Anodic Champagne, K: Satin Copper
Control Gear	E: On/Off, L: DALI, H: Touch-Dim, C: Casambi, 6: DALI DT6 for TW, 8: DALI DT8 for TW
Colour Rendering	8: CRI>80, 9: CRI>90, F: Full Spectrum [except 2200K]
Colour Temperature	22: 2200K, 27: 2700K, 30: 3000K, 35: 3500K, 40: 4000K, 65: 6500K, TW: Tunable White 2700-6500K [L1182-L2055]
Power	E: Low Power, M: Medium Power, H: High Power
Size	Luminaire Length in mm (Microprismatic, Opal Diffuser, Wallwasher): L600, L890, L1182, L1475, L1765, L2055 Luminaire Length in mm (Lens Louvre): L752, L1002, L1252, L1502, L1752, L2002
Lens Louvre*	W: Snow White, A: Satin Silver, B: Jet Black, H: Anodic Champagne, K: Satin Copper, G: Satin Gold
On Request	90°Corner, Midpin Downlight XD, Midpin Spotlights XM, Midpin Spotlights XP, 3-Phase Track, Multisensor [L1182-L2055], Emergency Module [L1182-L2055]

**Opal Diffuser made of sustainable TruCircle Polycarbonate / Fire Rated - Glow wire flammability Index 950°C EN60695-2-12 / Tp(a). Luminous flux reduction of 10%



Lens Louvre | Direct

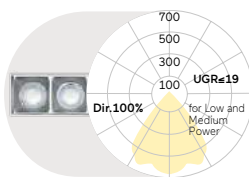

Microprismatic | Direct

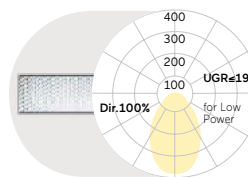

Opal Diffuser | Direct

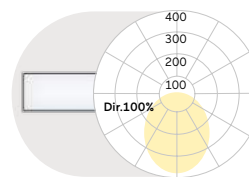

Wallwasher | Direct

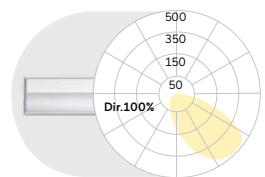

L mm	Lumen/Watt			L mm	Lumen/Watt			L mm	Lumen/Watt			L mm	Lumen/Watt		
	Low Power	Medium Power	High Power		Low Power	Medium Power	High Power		Low Power	Medium Power	High Power		Medium Power	High Power	
752	1370lm/11W	1870lm/15W	2690lm/22W	600	820lm/9W	1110lm/12W	1570lm/17W	600	900lm/9W	1210lm/12W	1720lm/17W	600	750lm/11W	1030lm/15W	
1002	1830lm/14W	2500lm/19W	3590lm/28W	890	1230lm/12W	1660lm/16W	2350lm/24W	890	1350lm/12W	1820lm/16W	2580lm/24W	890	1130lm/15W	1540lm/21W	
1252	2290lm/16W	3120lm/23W	4500lm/34W	1182	1640lm/16W	2210lm/21W	3130lm/31W	1182	1790lm/16W	2430lm/21W	3440lm/31W	1182	1500lm/19W	2060lm/27W	
1502	2750lm/19W	3750lm/27W	5380lm/40W	1475	2050lm/19W	2770lm/26W	3920lm/37W	1475	2240lm/19W	3030lm/26W	4300lm/37W	1475	1880lm/23W	2570lm/33W	
1752	3200lm/22W	4370lm/31W	6280lm/46W	1765	2450lm/22W	3320lm/30W	4700lm/44W	1765	2690lm/22W	3640lm/30W	5160lm/44W	1765	2250lm/28W	3090lm/39W	
2002	3660lm/25W	5000lm/35W	7180lm/53W	2055	2860lm/28W	3870lm/38W	5490lm/54W	2055	3140lm/28W	4250lm/38W	6020lm/54W	2055	2630lm/34W	3600lm/47W	

Lumen Values: Luminaire luminous flux at 4000K/CRI>80. Other configurations on request.

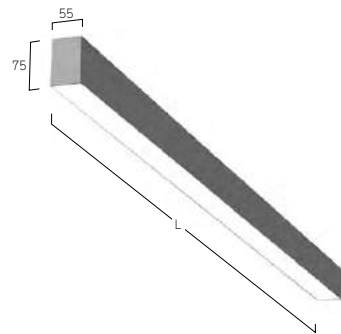

Matric A5 | System 81mm Surface



DE LED-Anbauleuchte für Wand- oder Deckenmontage. Rein direktstrahlend. Lichtkanal aus Aluminiumprofil mit 81mm Profillbreite. Millimetergenaue Längenfertigung nach Vorgabe möglich. Oberfläche natureloxiert oder weiß, graphit, schwarz, champagner oder kupferfarben lackiert. Weitere Oberflächenoptionen siehe Lightnet-Surface-Collection oder RAL nach Wahl. Microprismenoptik aus Spezialacrylglas und Satin-Louvre aus Aluminium mit optimierter Blendungsbegrenzung speziell für Office-Anwendungen. Satinierter Opaldiffusor für Allgemeinbeleuchtung mit max. Transmissionsgrad und homogener Lichtpunktauflösung. Wallwasher für homogene Beleuchtung vertikaler Flächen. Konverter in Leuchtgehäuse integriert, wahlweise einfach schaltbar oder stufenlos dimmbar (DALI, Touch-Dim, Casambi). Farbtemperatur 2200K, 2700K, 3000K, 3500K, 4000K, 6500K oder Tunable White (2700-6500K). Binning initial \leq MacAdam 3. Farbwiedergabe CRI>80, CRI>90 oder Full Spectrum. Auf Anfrage: Integration von Strahlern, Notlichtkomponenten, Sensortechnologie.

EN LED surface-mounted luminaire for walls or ceilings. Direct only light distribution. Light channel made of 81mm wide aluminium profile. Bespoke lengths possible. Surface natural anodised or white, graphite, black, champagne or copper coated. Further surface options see Lightnet-Surface-Collection or RAL of your choice. Microprismatic screen made of special acrylic glass and satin Louvre made of aluminum with optimized glare reduction especially for workplaces. Satin opal diffuser for general lighting with maximum transmittance and homogeneous lighting. Wallwasher for homogeneous illumination of vertical surfaces. Driver integrated into luminaire housing, optionally switchable or dimmable (DALI, Touch-Dim, Casambi). Colour temperature 2200K, 2700K, 3000K, 3500K, 4000K, 6500K or Tunable White (2700-6500K). Binning \leq MacAdam 3. Colour rendering CRI>80, CRI>90 or Full Spectrum. On request: Integration of spotlights, emergency lighting components, sensor technology.

LA50WE-830M-L890

- Product Family **L:** Matric
- Type **A5:** Direct only
- Optical System **A:** Microprismatic, **O:** Opal Diffuser, **M:** Satin Louvre, **G:** Wallwasher
- Surface Finish **W:** Snow White, **V:** Ivory White, **E:** Silver Anodised, **U:** Urban Graphite, **B:** Jet Black, **H:** Anodic Champagne, **K:** Satin Copper
- Control Gear **E:** On/Off, **L:** DALI, **H:** Touch-Dim, **C:** Casambi, **6:** DALI DT6 for TW, **8:** DALI DT8 for TW
- Colour Rendering **8:** CRI>80, **9:** CRI>90, **F:** Full Spectrum [except 2200K]
- Colour Temperature **22:** 2200K, **27:** 2700K, **30:** 3000K, **35:** 3500K, **40:** 4000K, **65:** 6500K, **TW:** Tunable White 2700-6500K [L890-L2055]
- Power **E:** Low Power, **M:** Medium Power, **H:** High Power
- Size Luminaire Length in mm: **L600, L890, L1182, L1475, L1765, L2055**
- On Request Special Length Versions, 90°Corner, Midpin Downlight XD, Midpin Spotlights XM, Midpin Spotlights XP, Midpoint Spotlights, 3-Phase Track, Multisensor [L1182-L2055], Emergency Module [L1182-L2055]



Microprismatic Direct				Opal Diffuser Direct				Satin Louvre Direct			Wallwasher Direct	
L mm	Lumen/Watt Low Power	Lumen/Watt Medium Power	Lumen/Watt High Power	L mm	Lumen/Watt Low Power	Lumen/Watt Medium Power	Lumen/Watt High Power	L mm	Lumen/Watt Medium Power	Lumen/Watt High Power	L mm	Lumen/Watt High Power
600	1000lm/11W	1380lm/15W	2010lm/21W	600	1180lm/11W	1620lm/15W	2360lm/21W	600	1270lm/15W	1840lm/21W	600	1180lm/15W
890	1510lm/15W	2070lm/21W	3020lm/31W	890	1760lm/15W	2430lm/21W	3530lm/31W	890	1900lm/21W	2770lm/31W	890	1770lm/21W
1182	2010lm/19W	2760lm/26W	4020lm/40W	1182	2350lm/19W	3230lm/26W	4710lm/40W	1182	2530lm/26W	3690lm/40W	1182	2360lm/27W
1475	2510lm/23W	3450lm/32W	5030lm/49W	1475	2940lm/23W	4040lm/32W	5890lm/49W	1475	3170lm/32W	4610lm/49W	1475	2950lm/33W
1765	3010lm/27W	4140lm/38W	6030lm/59W	1765	3530lm/27W	4850lm/38W	7070lm/59W	1765	3800lm/38W	5530lm/59W	1765	3540lm/39W
2055	3510lm/34W	4830lm/47W	7040lm/71W	2055	4120lm/34W	5660lm/47W	8240lm/71W	2055	4430lm/47W	6450lm/71W	2055	4130lm/47W

Lumen Values: Luminaire luminous flux at 4000K/CRI>80. Other configurations on request.

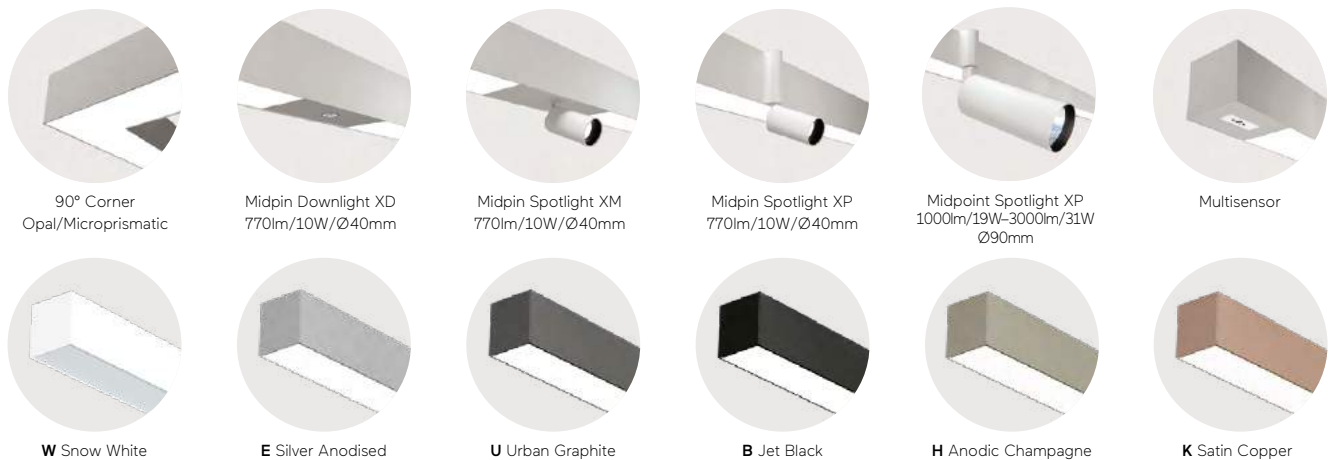
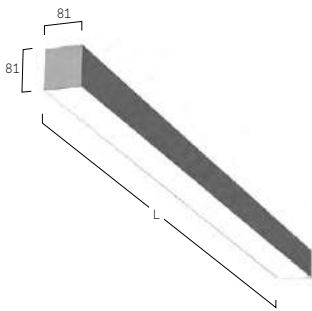

Matric A6 | System 81mm Surface



DE LED-Anbauleuchte für Wand- oder Deckenmontage. Rein direktstrahlend. Lichtkanal aus Aluminiumprofil mit 81mm Profildbreite und 60mm Bauhöhe. Millimetergenaue Längenfertigung nach Vorgabe möglich. Oberfläche natureloxiert oder weiß, graphit, schwarz, champagner oder kupferfarben lackiert. Weitere Oberflächenoptionen siehe Lightnet-Surface-Collection oder RAL nach Wahl. Microprismenoptik aus Spezialacrylglas mit optimierter Blendungsbegrenzung für Office-Anwendungen. Satinierter Opaldiffusor für Allgemeinbeleuchtung mit max. Transmissionsgrad und homogener Lichtpunktauflösung. Wallwasher für homogene Beleuchtung vertikaler Flächen. Konverter in Leuchtgehäuse integriert, wahlweise einfach schaltbar oder stufenlos dimmbar (DALI, Touch-Dim, Casambi). Farbtemperatur 2200K, 2700K, 3000K, 3500K, 4000K, 6500K oder Tunable White (2700-6500K). Binning initial \leq MacAdam 3. Farbwiedergabe CRI>80, CRI>90 oder Full Spectrum. Auf Anfrage: Integration von Strahlern, Notlichtkomponenten, Sensortechnologie.

EN LED surface-mounted luminaire for walls or ceilings. Direct only light distribution. Light channel made of 81mm wide by 60mm high aluminium profile. Bespoke lengths possible. Surface natural anodised or white, graphite, black, champagne or copper coated. Further surface options see Lightnet-Surface-Collection or RAL of your choice. Microprismatic screen made of special acrylic glass with optimized glare reduction especially for workplaces. Satin opal diffuser for general lighting with maximum transmittance and homogeneous lighting. Wallwasher for homogeneous illumination of vertical surfaces. Driver integrated into luminaire housing, optionally switchable or dimmable (DALI, Touch-Dim, Casambi). Colour temperature 2200K, 2700K, 3000K, 3500K, 4000K, 6500K or Tunable White (2700-6500K). Binning \leq MacAdam 3. Colour rendering CRI>80, CRI>90 or Full Spectrum. On request: Integration of spotlights, emergency lighting components, sensor technology.

L A60 WE - 830 M - L890

- Product Family **L:** Matric
- Type **A6:** Direct only
- Optical System **A:** Microprismatic, **O:** Opal Diffuser, **J:** Wallwasher
- Surface Finish **W:** Snow White, **V:** Ivory White, **E:** Silver Anodised, **U:** Urban Graphite, **B:** Jet Black, **H:** Anodic Champagne, **K:** Satin Copper
- Control Gear **E:** On/Off, **L:** DALI, **H:** Touch-Dim, **C:** Casambi, **6:** DALI DT6 for TW, **8:** DALI DT8 for TW
- Colour Rendering **8:** CRI>80, **9:** CRI>90, **F:** Full Spectrum [except 2200K]
- Colour Temperature **22:** 2200K, **27:** 2700K, **30:** 3000K, **35:** 3500K, **40:** 4000K, **65:** 6500K, **TW:** Tunable White 2700-6500K [L890-L2055]
- Power **E:** Low Power, **M:** Medium Power, **H:** High Power
- Size Luminaire Length in mm: **L600, L890, L1182, L1475, L1765, L2055**
- On Request Special Length Versions, 90°Corner, Midpin Downlight XD, Midpin Spotlights XM, Midpin Spotlights XP, Midpoint Spotlights, Multisensor [L1182-L2055], Emergency Module [L1182-L2055]



Microprismatic | Direct

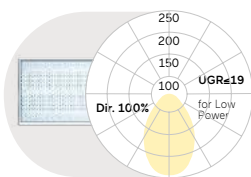

Opal Diffuser | Direct

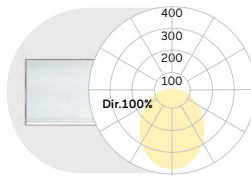

Wallwasher | Direct

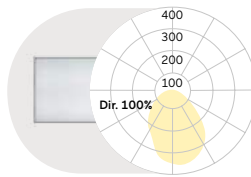

L mm	Lumen/Watt Low Power	Lumen/Watt Medium Power	Lumen/Watt High Power
600	1030lm/10W	1420lm/14W	2000lm/19W
890	1580lm/15W	2110lm/19W	2840lm/26W
1182	2100lm/19W	2810lm/25W	3790lm/34W
1475	2630lm/23W	3510lm/31W	4740lm/42W
1765	3150lm/27W	4220lm/36W	5690lm/49W
2055	3680lm/31W	4920lm/42W	6640lm/57W

L mm	Lumen/Watt Low Power	Lumen/Watt Medium Power	Lumen/Watt High Power
600	1250lm/10W	1730lm/14W	2430lm/19W
890	1920lm/15W	2560lm/19W	3460lm/26W
1182	2560lm/19W	3420lm/25W	4610lm/34W
1475	3200lm/23W	4270lm/31W	5760lm/42W
1765	3840lm/27W	5130lm/36W	6920lm/49W
2055	4470lm/31W	5980lm/42W	8070lm/57W

L mm	Lumen/Watt Low Power	Lumen/Watt Medium Power	Lumen/Watt High Power
600	1080lm/10W	1490lm/14W	2100lm/19W
890	1650lm/15W	2210lm/19W	2980lm/26W
1182	2200lm/19W	2940lm/25W	3970lm/34W
1475	2750lm/23W	3680lm/31W	4960lm/42W
1765	3300lm/27W	4420lm/36W	5960lm/49W
2055	3850lm/31W	5150lm/42W	6950lm/57W

Lumen Values: Luminaire luminous flux at 4000K/CRI>80. Other configurations on request.

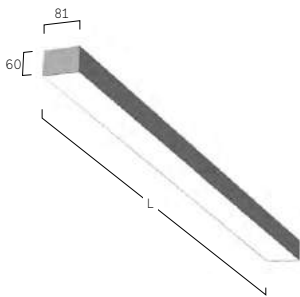

90° Corner
Opal/Microprismatic



Midpin Downlight XD
770lm/10W/Ø40mm



Midpin Spotlight XM
770lm/10W/Ø40mm



Midpin Spotlight XP
770lm/10W/Ø40mm



Midpoint Spotlight XP
1000lm/19W-3000lm/31W
Ø90mm



Multisensor



W Snow White

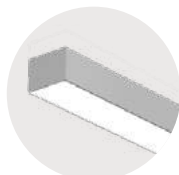

E Silver Anodised

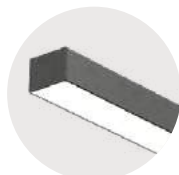

U Urban Graphite



B Jet Black

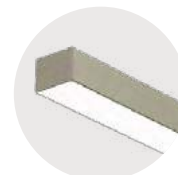

H Anodic Champagne



K Satin Copper

Vision Gen. 4 A4/X4 | Surface



DE LED-Anbauleuchte für Wand- oder Deckenmontage. Direktstrahlend mit indirekter Lichtkorona oder rein direktstrahlend. Leuchtenkörper aus Aluminiumprofil mit 125mm Profilhöhe und 40mm Bauhöhe. Millimetergenaue Längenfertigung nach Vorgabe möglich. Oberfläche natureloxiert oder weiß, graphit, schwarz, champagner oder kupferfarben lackiert. Weitere Oberflächenoptionen siehe Lightnet-Surface-Collection oder RAL nach Wahl. Direktanteil über Präzisionslinsen mit Abblenderaster für breite rotationssymmetrische Lichtstärkeverteilung bei gleichzeitig hoher Blendungsbegrenzung (UGR<19) für Office Anwendungen. Abblenderaster in verschiedenen Farbkombinationen erhältlich. Microprismenoptik aus Spezialacrylglas mit optimierter Blendungsbegrenzung für Office-Anwendungen. Satiniertes Opaldiffusor für Allgemeinbeleuchtung mit max. Transmissionsgrad und homogener Lichtpunktauflösung. Wallwasher für homogene Beleuchtung vertikaler Flächen. Indirektanteil mit innovativer Linsentechnologie für breitstrahlende Deckenaufhellung. Konverter in Leuchtengehäuse integriert, wahlweise einfach schaltbar oder stufenlos dimmbar (DALI, Touch-Dim, Casambi). Farbtemperatur 2200K, 2700K, 3000K, 3500K, 4000K, 6500K oder Tunable White (2700-6500K). Binning initial \leq MacAdam 3. Farbwiedergabe CRI>80, CRI>90 oder Full Spectrum. Auf Anfrage: Integration von Stromschienen und Strahlern, Notlichtkomponenten, Sensortechnologie.

EN LED surface-mounted luminaire for walls or ceilings. Direct and indirect light distribution or direct only light distribution. Luminaire body made of 125mm wide by 40mm high aluminium profile. Bespoke lengths possible. Surface natural anodised or white, graphite, black, champagne or copper coated. Further surface options see Lightnet-Surface-Collection or RAL of your choice. Direct light using precision lenses with louvre for wide uniform symmetrical light distribution with high glare limitation (UGR<19) especially for workplaces. Louvre available in various colour finishes. Microprismatic screen made of special acrylic glass with optimized glare reduction especially for workplaces. Satin opal diffuser for general lighting with maximum transmittance and homogeneous lighting. Wallwasher for homogeneous illumination of vertical surfaces. Indirect light with innovative lens technology for wide-angle ceiling illumination. Driver integrated into luminaire housing, optionally switchable or dimmable (DALI, Touch-Dim, Casambi). Colour temperature 2200K, 2700K, 3000K, 3500K, 4000K, 6500K or Tunable White (2700-6500K). Binning \leq MacAdam 3. Colour rendering CRI>80, CRI>90 or Full Spectrum. On request: Integration of tracks and spotlights, emergency lighting components, sensor technology.

V X4 L WE-8 30 M-L1254-A*

Product Family	V: Vision
Type	A4: Direct only, X4: Direct-Indirect
Optical System	L: Lens Louvre*, A: Microprismatic, O: Opal Diffuser, D: Opal Diffuser (Polycarbonate)**, J: Wallwasher
Surface Finish	W: Snow White, E: Silver Anodised, U: Urban Graphite, B: Jet Black, H: Anodic Champagne, K: Satin Copper
Control Gear	E: On/Off, L: DALI, H: Touch-Dim, C: Casambi, 6: DALI DT6 for TW, 8: DALI DT8 for TW
Colour Rendering	8: CRI>80, 9: CRI>90, F: Full Spectrum [except 2200K]
Colour Temperature	22: 2200K, 27: 2700K, 30: 3000K, 35: 3500K, 40: 4000K, 65: 6500K, TW: Tunable White 2700-6500K
Power	E: Low Power, M: Medium Power, H: High Power
Size	Luminaire length in mm [Microprismatic, Opal Diffuser, Wallwasher]: L890, L1182, L1475, L1765, L2055 Luminaire length in mm [Lens Louvre]: L754, L1004, L1254, L1504, L1754, L2004
Lens Louvre*	W: Snow White, A: Satin Silver, B: Jet Black, H: Anodic Champagne, K: Satin Copper, G: Satin Gold

**Opal Diffuser made of sustainable TruCircle Polycarbonate / Fire Rated - Glow wire flammability Index 950°C EN60695-2-12 / Tp(a). Luminous flux reduction of 10%



Lens Louvre Direct-Indirect			Microprismatic Direct-Indirect			Opal Diffuser Direct-Indirect			Wallwasher Direct-Indirect				
L mm	Lumen/Watt Medium Power	Lumen/Watt High Power	L mm	Lumen/Watt Low Power	Lumen/Watt Medium Power	Lumen/Watt High Power	L mm	Lumen/Watt Low Power	Lumen/Watt Medium Power	Lumen/Watt High Power	L mm	Lumen/Watt Medium Power	Lumen/Watt High Power
754	3180lm/26W	4480lm/36W	890	2640lm/23W	3630lm/31W	5030lm/43W	890	2760lm/23W	3790lm/31W	5260lm/43W	890	3470lm/31W	4810lm/43W
1004	4470lm/34W	6270lm/48W	1182	3520lm/29W	4840lm/40W	6710lm/56W	1182	3670lm/29W	5060lm/40W	7020lm/56W	1182	4630lm/40W	6420lm/56W
1254	5750lm/42W	8080lm/61W	1475	4400lm/35W	6060lm/48W	8390lm/69W	1475	4590lm/35W	6320lm/48W	8770lm/69W	1475	5790lm/48W	8020lm/69W
1504	7040lm/50W	9850lm/73W	1765	5270lm/41W	7260lm/57W	10070lm/82W	1765	5510lm/41W	7580lm/57W	10530lm/82W	1765	6940lm/57W	9620lm/82W
1754	8310lm/58W	11650lm/85W	2055	6150lm/52W	8470lm/71W	11750lm/99W	2055	6430lm/52W	8850lm/71W	12280lm/99W	2055	8100lm/71W	11220lm/99W
2004	9600lm/69W	13440lm/100W											

Lens Louvre Direct			Microprismatic Direct			Opal Diffuser Direct			Wallwasher Direct				
L mm	Lumen/Watt Medium Power	Lumen/Watt High Power	L mm	Lumen/Watt Low Power	Lumen/Watt Medium Power	Lumen/Watt High Power	L mm	Lumen/Watt Low Power	Lumen/Watt Medium Power	Lumen/Watt High Power	L mm	Lumen/Watt Medium Power	Lumen/Watt High Power
754	1870lm/15W	2690lm/22W	890	1230lm/12W	1660lm/16W	2350lm/23W	890	1350lm/12W	1820lm/16W	2580lm/23W	890	1500lm/16W	2130lm/23W
1004	2500lm/19W	3590lm/28W	1182	1640lm/15W	2210lm/20W	3130lm/29W	1182	1790lm/15W	2430lm/20W	3440lm/29W	1182	2000lm/20W	2840lm/29W
1254	3120lm/23W	4500lm/34W	1475	2050lm/18W	2770lm/25W	3920lm/36W	1475	2240lm/18W	3030lm/25W	4300lm/36W	1475	2500lm/25W	3550lm/36W
1504	3750lm/27W	5380lm/40W	1765	2450lm/22W	3320lm/29W	4700lm/43W	1765	2690lm/22W	3640lm/29W	5160lm/43W	1765	3000lm/29W	4250lm/43W
1754	4370lm/31W	6280lm/46W	2055	2860lm/27W	3870lm/36W	5490lm/52W	2055	3140lm/27W	4250lm/36W	6020lm/52W	2055	3500lm/36W	4960lm/52W

Lumen Values: Luminaire luminous flux at 4000K/CRI>80. Other configurations on request.

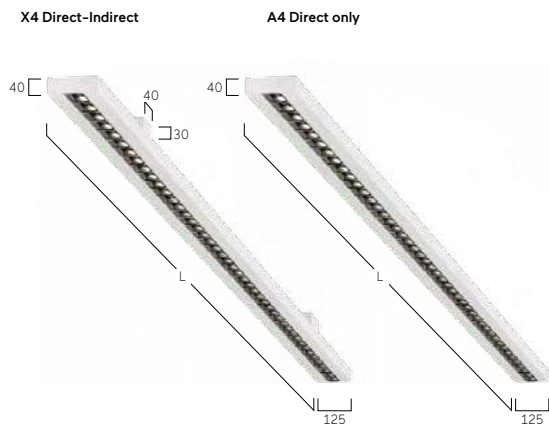

Plank Y4/X4 | Surface



DE LED-Anbauleuchte für Wand- oder Deckenmontage. Direktstrahlend mit indirekter Lichtkorona oder rein direktstrahlend. Leuchtenkörper aus Aluminiumprofil mit 25mm Bauhöhe. Oberfläche natureloxiert oder weiß, graphit, schwarz, champagner oder kupferfarben lackiert. Weitere Oberflächenoptionen siehe Lightnet-Surface-Collection oder RAL nach Wahl. Microprismenoptik aus Spezialacrylglas mit optimierter Blendungsbegrenzung für Office-Anwendungen. Satinierter Opaldiffusor für Allgemeinbeleuchtung mit max. Transmissionsgrad und homogener Lichtpunktauflösung. Konverter in Leuchtgehäuse integriert, wahlweise einfach schaltbar oder stufenlos dimmbar (DALI, Touch-Dim, Casambi). Farbtemperatur 2200K, 2700K, 3000K, 3500K, 4000K, 6500K oder Tunable White (2700-6500K). Binning initial \leq MacAdam 3. Farbwiedergabe CRI>80, CRI>90 oder Full Spectrum. Auf Anfrage: Integration von Stromschienen und Strahlern, Notlichtkomponenten, Sensortechnologie.

EN LED surface-mounted luminaire for walls or ceilings. Direct and indirect light distribution or direct only light distribution. Luminaire body made of 25mm high aluminium profile. Surface natural anodised or white, graphite, black, champagne or copper coated. Further surface options see Lightnet-Surface-Collection or RAL of your choice. Microprismatic screen made of special acrylic glass with optimized glare reduction especially for workplaces. Satin opal diffuser for general lighting with maximum transmittance and homogeneous lighting. Driver integrated into luminaire housing, optionally switchable or dimmable (DALI, Touch-Dim, Casambi). Colour temperature 2200K, 2700K, 3000K, 3500K, 4000K, 6500K or Tunable White (2700-6500K). Binning \leq MacAdam 3. Colour rendering CRI>80, CRI>90 or Full Spectrum. On request: Integration of tracks and spotlights, emergency lighting components, sensor technology.

JX4 A WE-8 30 M-L1210

Product Family	J: Plank
Type	X4: Direct-Indirect, Y4: Direct only
Optical System	A: Microprismatic, O: Opal Diffuser
Surface Finish	W: Snow White, E: Silver Anodised, U: Urban Graphite, B: Jet Black, H: Anodic Champagne, K: Satin Copper
Control Gear	E: On/Off, L: DALI, H: Touch-Dim, C: Casambi, 6: DALI DT6 for TW, 8: DALI DT8 for TW
Colour Rendering	8: CRI>80, 9: CRI>90, F: Full Spectrum [except 2200K]
Colour Temperature	22: 2200K, 27: 2700K, 30: 3000K, 35: 3500K, 40: 4000K, 65: 6500K, TW: Tunable White 2700-6500K
Power	M: Medium Power, H: High Power
Size	Luminaire length in mm: L920, L1210, L1500, L1800



Microprismatic | Direct-Indirect

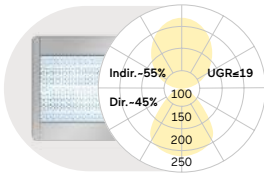

Microprismatic | Direct

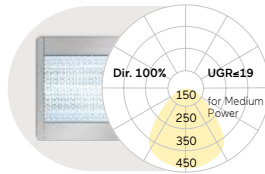

Opal Diffuser | Direct-Indirect

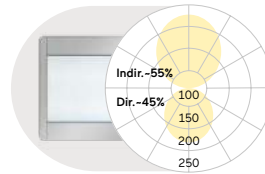

Opal Diffuser | Direct

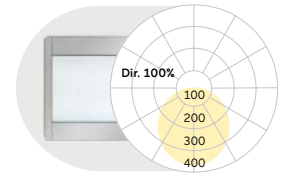

L mm	Lumen/Watt		L mm	Lumen/Watt		L mm	Lumen/Watt		L mm	Lumen/Watt	
	Medium Power	High Power		Medium Power	High Power		Medium Power	High Power		Medium Power	High Power
920	2840lm/24W	4530lm/38W	920	1340lm/13W	2130lm/21W	920	2750lm/24W	4380lm/38W	920	1250lm/13W	1980lm/21W
1210	3790lm/33W	6030lm/53W	1210	1790lm/17W	2840lm/27W	1210	3670lm/33W	5830lm/53W	1210	1670lm/17W	2640lm/27W
1500	4740lm/40W	7540lm/64W	1500	2240lm/20W	3550lm/33W	1500	4580lm/40W	7290lm/64W	1500	2080lm/20W	3300lm/33W
1800	5690lm/47W	9050lm/76W	1800	2690lm/24W	4260lm/39W	1800	5500lm/47W	8750lm/76W	1800	2500lm/24W	3960lm/39W

Lumen Values: Luminaire luminous flux at 4000K/CRI>80. Other configurations on request.

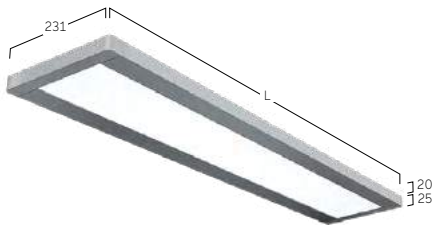

W Snow White



E Silver Anodised



U Urban Graphite



B Jet Black



H Anodic Champagne



K Satin Copper



Midpin M2 |
Recessed
432



Midpoint E6 |
Semi-Recessed
436

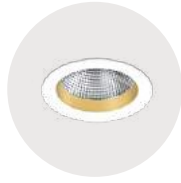

Midpoint F7 |
Recessed
438



Midpoint M6 |
Recessed
440



Basic Superflat L7 |
Semi-Recessed
442



Basic Déco N3 |
Recessed Frameless
444



Basic Déco L3 |
Recessed Frame
446



Basic Max M2 |
Recessed Frameless
450



Basic Max M4 |
Recessed Frame
452



Basic Visio L9 |
Semi-Recessed
454



Ringo Star Compact F5 |
Recessed Frame
456



Ringo Star FX | System
40mm Recessed Frame
458



Ringo Star F1 | System
100mm Recessed Frame
462



Liquid Line Compact F5 |
Recessed Frame
464



Liquid Line QX/FX |
System 40mm Recessed
466



Liquid Line F3 | System
60mm Recessed
474



Caleo Max M2 |
Recessed Frameless
478



Cubic Max M2 |
Recessed Frameless
480



Cubic Max M4 |
Recessed Frame
482



Cubic Ambient M7 |
Recessed Frame
484



Cubic Déco L3 |
Recessed Frame
486



Matric Déco M9 |
Recessed Frameless
488



Matric Déco F9 |
Recessed Frame
490



Matric MX | System 40mm
Recessed Frameless
498

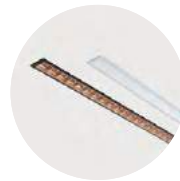

Matric FX | System
40mm Recessed Frame
500



Matric M3 | System
55mm Recessed Frameless
502



Matric F3 | System
55mm Recessed Frame
504



Matric M5 | System 81mm
Recessed Frameless
506



Matric F5 | System
81mm Recessed Frame
508

Einbau | Recessed

Midpin M2 | Recessed



DE LED-Strahler für Einbaumontage in gesägten Deckenöffnungen. Dreh- und schwenkbar. Separater Konverter im Lieferumfang enthalten, wahlweise einfach schaltbar oder stufenlos dimmbar (DALI). Gehäuse aus Aluminium in weiß, silber, schwarz oder champagnerfarben lackiert. Weitere Oberflächenoptionen siehe Lightnet Surface Collection oder RAL nach Wahl. Farbtemperatur wahlweise 2700K, 3000K oder 4000K oder als Dim to Warm 3000K-1800K. Farbwiedergabe CRI>90. Binning initial \leq MacAdam 3. Austauschbare Linsenoptik mit Ausstrahlwinkel 30° (Medium) oder 40° (Flood). Optikring in verschiedenen Farbausführungen erhältlich.

EN LED recessed spotlight for installation in ceiling cut-outs openings. Rotatable and tiltable. Separate driver included, optionally switchable or dimmable (DALI). Housing made of white, silver, black or champagne coated aluminum. Further surface options see Lightnet-Surface-Collection or RAL of your choice. Colour temperature available as 2700K, 3000K or 4000K or as Dim to Warm 3000K-1800K. Colour rendering CRI>90. Binning \leq MacAdam 3. Changeable lens optics with beam angle 30° (medium) or 40° (flood). Optic ring available in different colours.

DM2B BE-927M-G

Product Family	D: Midpin
Type	M2: Direct only
Lens Angle	B: Medium 30°, C: Flood 40°
Surface Finish	W: Snow White, B: Jet Black, H: Anodic Champagne
Control Gear	E: On/Off, L: DALI
Colour Rendering	9: CRI>90
Colour Temperature	27: 2700K, 30: 3000K, 35: 3500K, 40: 4000K, DW: Dim to Warm 1800K - 3000K [DALI only]
Power	M: Medium Power
Optic Ring	W: Snow White, V: Ivory White, A: Satin Silver, B: Jet Black, H: Anodic Champagne, G: Satin Gold, K: Satin Copper



Medium 30° Led Engine Eco, Medium Power

Mounting Height	Illuminance[Lux] center/side	Beam Diameter
1 m	2079/929	0.57 m
2 m	520/232	1.10 m
3 m	231/103	1.70 m
4 m	130/58	2.30 m

LED Engine	2700K	3000K	3500K	4000K
11W	610 lm	710 lm	750 lm	750 lm

Flood 40° Led Engine Eco, Medium Power

Mounting Height	Illuminance[Lux] center/side	Beam Diameter
1 m	1454/591	0.77 m
2 m	364/148	1.50 m
3 m	162/66	2.30 m
4 m	91/37	3.10 m

LED Engine	2700K	3000K	3500K	4000K
11W	620 lm	730 lm	770 lm	770 lm



B Jet Black
W Snow White



B Jet Black
A Satin Silver



B Jet Black
B Jet Black

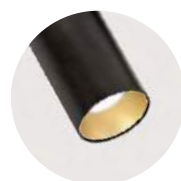

B Jet Black
G Satin Gold

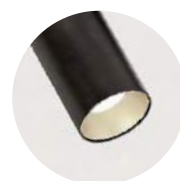

B Jet Black
H Anodic Champagne

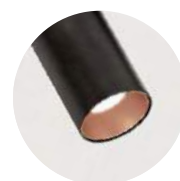

B Jet Black
K Satin Copper

Midpoint Recessed



Vögele Sanitary, Freiburg, Germany
Midpoint M6



Ideal Insurance, Berlin, Germany
Midpoint M6

Midpoint E6 | Semi-Recessed



DE LED-Strahler für Einbaumontage in gesägten Deckenöffnungen. 350° drehbar und 90° schwenkbar. Separater Konverter im Lieferumfang enthalten, wahlweise einfach schaltbar oder stufenlos dimmbar (DALI). Gehäuse aus Aluminium in weiß, silber, schwarz oder champagnerfarben lackiert. Weitere Oberflächenoptionen siehe Lightnet Surface Collection oder RAL nach Wahl. LED Engine wahlweise XICATO ARTIST für höchste Lichtqualität mit bester Farbwiedergabe und 5 Jahre Garantie für Farbkonstanz (MacAdam \leq 3) oder ECO für höchste Energieeffizienz bei optimalem Preis-Leistungsverhältnis und CRI $>$ 90. Farbtemperaturen 2700K, 3000K oder 4000K. Austauschbare Linsen-Reflektoroptiken mit sphärischer Facettenoptik. Ausstrahlwinkel: 10° (Spot), 20° (Medium), 35° (Flood) oder 50° (Wide Flood). Reflektorring in verschiedenen Farbausführungen erhältlich. Standardmäßig klare Abdeckung. Optional zusätzliche Filter oder Wabenraster.

EN LED recessed spotlight for installation in ceilings. 350° rotation and 90° tilt. Separate driver included, optionally switchable or dimmable (DALI). Housing made of white, silver, black or champagne coated aluminum. Further surface options see Lightnet-Surface-Collection or RAL of your choice. LED Engine with XICATO ARTIST for highest light quality and colour rendering, including 5-year warranty for colour consistency (MacAdams 3) or ECO for highest energy efficiency with optimal price performance ratio and CRI $>$ 90. Colour temperature 2700K, 3000K or 4000K. Replaceable lens reflector optic with spherical faceted optic. Beam angle: 10° (Spot), 20° (Medium), 35° (Flood) or 50° (Wide Flood). Reflector ring available in different colours. Standard clear cover. Optional additional filters or honeycomb louvre.

PE6BSE-927FM-BK

- Product Family **P:** Midpoint
- Type **E6:** Direct only
- Beam Angle **A:** Spot 10°, **B:** Medium 20°, **C:** Flood 35°, **D:** Wide Flood 50°
- Surface Finish **W:** Snow White, **V:** Ivory White, **S:** Radiant Silver, **B:** Jet Black, **H:** Anodic Champagne
- Control Gear **E:** On/Off, **L:** DALI, **H:** Touch-Dim
- Colour Rendering **9:** CRI>90
- Colour Temperature **27:** 2700K, **30:** 3000K, **40:** 4000K
- Led-Engine **F:** Eco [Ra> 90], **A:** Artist [Ra> 97, Xicato]
- Power **E:** Low Power **M:** Medium Power
- Optic Ring **W:** Snow White, **V:** Ivory White, **S:** Radiant Silver, **B:** Jet Black, **H:** Anodic Champagne, **G:** Satin Gold, **K:** Satin Copper
- Cover **K:** Clear Cover [Standard], **P:** Prismatic Lens, **H:** Honeycomb Louvre
- On Request Optic Removal Tool for clear cover



Spot 10° Led Engine Eco, Medium Power

Mounting Height	Illuminance [Lux] center/side	Beam Diameter
1 m	25250/12700	0.24 m
2 m	6312/3175	0.48 m
3 m	2806/1411	0.72 m
4 m	1578/794	0.95 m

LED Engine	2700K	3000K	4000K
Eco Low			
Power [19W]	1230 lm	1350 lm	1440 lm
Eco Medium			
Power [31W]	1660 lm	1860 lm	2020 lm
Artist Low			
Power [19W]	1040 lm	1090 lm	1190 lm
Artist Medium			
Power [31W]	1400 lm	1480 lm	1560 lm

Medium 20° Led Engine Eco, Medium Power

Mounting Height	Illuminance [Lux] center/side	Beam Diameter
1 m	17447/8455	0.32 m
2 m	4362/2114	0.64 m
3 m	1939/939	0.96 m
4 m	1090/528	1.30 m

LED Engine	2700K	3000K	4000K
Eco Low			
Power [19W]	1580 lm	1740 lm	1850 lm
Eco Medium			
Power [31W]	2360 lm	2640 lm	2870 lm
Artist Low			
Power [19W]	1330 lm	1390 lm	1510 lm
Artist Medium			
Power [31W]	1980 lm	2110 lm	2220 lm

Flood 35° Led Engine Eco, Medium Power

Mounting Height	Illuminance [Lux] center/side	Beam Diameter
1 m	6251/2731	0.63 m
2 m	1563/683	1.30 m
3 m	695/303	1.90 m
4 m	391/171	2.50 m

LED Engine	2700K	3000K	4000K
Eco Low			
Power [19W]	1530 lm	1680 lm	1790 lm
Eco Medium			
Power [31W]	2280 lm	2550 lm	2780 lm
Artist Low			
Power [19W]	1290 lm	1350 lm	1470 lm
Artist Medium			
Power [31W]	1930 lm	2060 lm	2160 lm

Wide Flood 50° Led Engine Eco, Medium Power

Mounting Height	Illuminance [Lux] center/side	Beam Diameter
1 m	3550/1319	0.94 m
2 m	887/330	1.90 m
3 m	394/147	2.80 m
4 m	222/82	3.80 m

LED Engine	2700K	3000K	4000K
Eco Low			
Power [19W]	1440 lm	1580 lm	1680 lm
Eco Medium			
Power [31W]	2230 lm	2490 lm	2710 lm
Artist Low			
Power [19W]	1250 lm	1310 lm	1430 lm
Artist Medium			
Power [31W]	1910 lm	2040 lm	2140 lm



Optic Removal Tool for clear cover

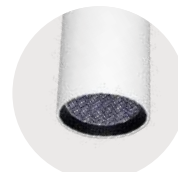

Honeycomb Louvre



Prismatic Lens



W Snow White
W Snow White

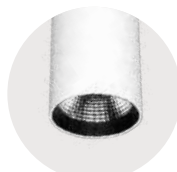

W Snow White
B Jet Black



W Snow White
G Satin Gold

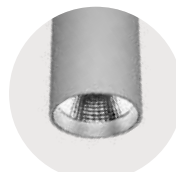

S Radiant Silver
S Radiant Silver

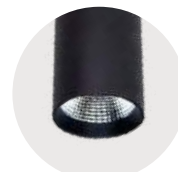

B Jet Black
B Jet Black

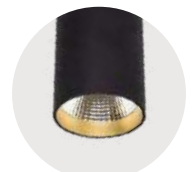

B Jet Black
G Satin Gold

Midpoint F7 | Recessed



DE LED-Strahler für Einbaumontage in gesägten Deckenöffnungen. Separater Konverter im Lieferumfang enthalten, wahlweise einfach schaltbar oder stufenlos dimmbar (DALI). Gehäuse aus Aluminium in weiß, silber, schwarz oder champagnerfarben lackiert. Weitere Oberflächenoptionen siehe Lightnet Surface Collection oder RAL nach Wahl. LED Engine wahlweise XICATO ARTIST für höchste Lichtqualität mit bester Farbwiedergabe (CRI>97) und 5 Jahre Garantie für Farbkonstanz (MacAdam \leq 3) oder ECO für höchste Energieeffizienz bei optimalem Preis-Leistungsverhältnis und CRI>90. Farbtemperaturen 2700K, 3000K oder 4000K. Austauschbare Linsen-Reflektoroptiken mit sphärischer Facettenoptik. Ausstrahlwinkel: 10° (Spot), 20° (Medium), 35° (Flood) oder 50° (Wide Flood). Reflektoring in verschiedenen Farbausführungen erhältlich. Standardmäßig klare Abdeckung. Optional zusätzliche Filter oder Wabenraster.

EN LED recessed spotlight for installation in ceilings. Separate driver included, optionally switchable or dimmable (DALI). Housing made of white, silver, black or champagne coated aluminum. Further surface options see Lightnet-Surface-Collection or RAL of your choice. LED Engine with XICATO ARTIST for highest light quality and colour rendering (CRI>97), including 5-year warranty for colour consistency (MacAdams 3) or ECO for highest energy efficiency with optimal price-performance ratio and CRI> 90. Colour temperature 2700K, 3000K or 4000K. Replaceable lens reflector optic with spherical faceted optic. Beam angle: 10° (Spot), 20° (Medium), 35° (Flood) or 50° (Wide Flood). Reflector ring available in different colour versions. Standard clear cover. Optional additional filters or honeycomb louvre.

PF7BSE-927FM-BK

Product Family	P: Midpoint
Type	F7: Direct only
Beam Angle	A: Spot 10°, B: Medium 20°, C: Flood 35°, D: Wide Flood 50°
Surface Finish	W: Snow White, V: Ivory White, S: Radiant Silver, B: Jet Black, H: Anodic Champagne
Control Gear	E: On/Off, L: DALI, H: Touch-Dim
Colour Rendering	9: CRI>90
Colour Temperature	27: 2700K, 30: 3000K, 40: 4000K
Led-Engine	F: Eco [Ra> 90], A: Artist [Ra> 97, Xicato]
Power	E: Low Power M: Medium Power
Optic Ring	W: Snow White, V: Ivory White, S: Radiant Silver, B: Jet Black, H: Anodic Champagne, G: Satin Gold, K: Satin Copper
Cover	K: Clear Cover [Standard], P: Prismatic Lens, H: Honeycomb Louvre
On Request	Optic Removal Tool for clear cover



Spot 10° Led Engine Eco, Medium Power

Mounting Height	Illuminance[Lux] center/side	Beam Diameter
1 m	25250/12700	0.24 m
2 m	6312/3175	0.48 m
3 m	2806/1411	0.72 m
4 m	1578/794	0.95 m

LED Engine	2700K	3000K	4000K
Eco Low Power [19W]	1230lm	1350lm	1440lm
Eco Medium Power [31W]	1660lm	1860lm	2020lm
Artist Low Power [19W]	1040lm	1090lm	1190lm
Artist Medium Power [31W]	1400lm	1480lm	1560lm

Medium 20° Led Engine Eco, Medium Power

Mounting Height	Illuminance[Lux] center/side	Beam Diameter
1 m	17447/8455	0.32 m
2 m	4362/2114	0.64 m
3 m	1939/939	0.96 m
4 m	1090/528	1.30 m

LED Engine	2700K	3000K	4000K
Eco Low Power [19W]	1580lm	1740lm	1850lm
Eco Medium Power [31W]	2360lm	2640lm	2870lm
Artist Low Power [19W]	1330lm	1390lm	1510lm
Artist Medium Power [31W]	1980lm	2110lm	2220lm

Flood 35° Led Engine Eco, Medium Power

Mounting Height	Illuminance[Lux] center/side	Beam Diameter
1 m	6251/2731	0.63 m
2 m	1563/683	1.30 m
3 m	695/303	1.90 m
4 m	391/171	2.50 m

LED Engine	2700K	3000K	4000K
Eco Low Power [19W]	1530lm	1680lm	1790lm
Eco Medium Power [31W]	2280lm	2550lm	2780lm
Artist Low Power [19W]	1290lm	1350lm	1470lm
Artist Medium Power [31W]	1930lm	2060lm	2160lm

Wide Flood 50° Led Engine Eco, Medium Power

Mounting Height	Illuminance[Lux] center/side	Beam Diameter
1 m	3550/1319	0.94 m
2 m	887/330	1.90 m
3 m	394/147	2.80 m
4 m	222/82	3.80 m

LED Engine	2700K	3000K	4000K
Eco Low Power [19W]	1440lm	1580lm	1680lm
Eco Medium Power [31W]	2230lm	2490lm	2710lm
Artist Low Power [19W]	1250lm	1310lm	1430lm
Artist Medium Power [31W]	1910lm	2040lm	2140lm

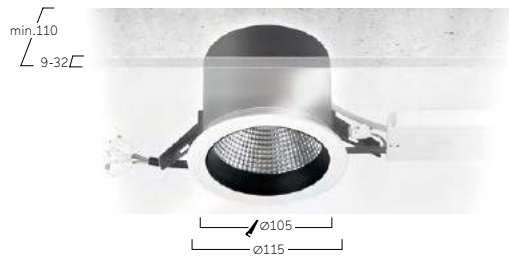

Optic Removal Tool for clear cover



Honeycomb Louvre



Prismatic Lens

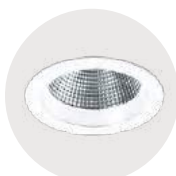

W Snow White
W Snow White



W Snow White
B Jet Black

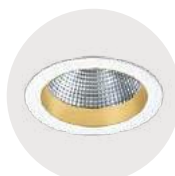

W Snow White
G Satin Gold



S Radiant Silver
S Radiant Silver



B Jet Black
B Jet Black

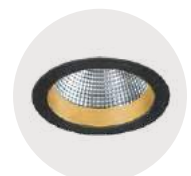

B Jet Black
G Satin Gold

Midpoint M6 | Recessed

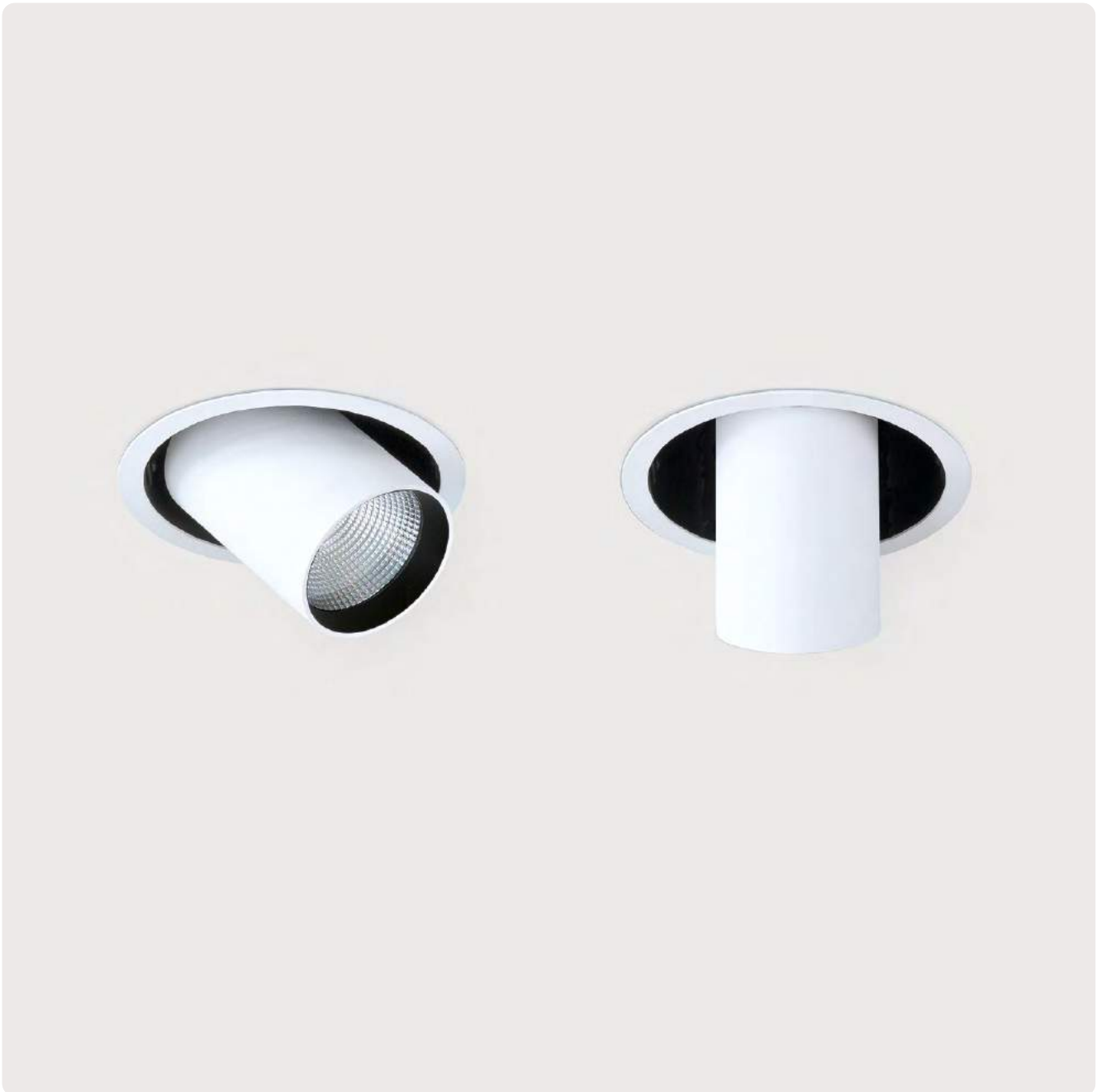

DE LED-Strahler für Einbaumontage in gesägten Deckenöffnungen. 350° drehbar und 90° schwenkbar. Separater Konverter im Lieferumfang enthalten, wahlweise einfach schaltbar oder stufenlos dimmbar (DALI). Gehäuse aus Aluminium in weiß, silber, schwarz oder champagnerfarben lackiert. Weitere Oberflächenoptionen siehe Lightnet Surface Collection oder RAL nach Wahl. LED Engine wahlweise XICATO ARTIST für höchste Lichtqualität mit bester Farbwiedergabe (CRI>97) und 5 Jahre Garantie für Farbkonstanz (MacAdam \leq 3) oder ECO für höchste Energieeffizienz bei optimalem Preis-Leistungsverhältnis und CRI>90. Farbtemperaturen 2700K, 3000K oder 4000K. Austauschbare Linsen-Reflektoroptiken mit sphärischer Facettenoptik. Ausstrahlwinkel: 10° (Spot), 20° (Medium), 35° (Flood) oder 50° (Wide Flood). Reflektorring in verschiedenen Farbausführungen erhältlich. Standardmäßig klare Abdeckung. Optional zusätzliche Filter oder Wabenraster.

EN LED recessed spotlight for installation in ceiling cut-outs openings. 350° rotation and 90° tilt. Separate driver included, optionally switchable or dimmable (DALI). Housing made of white, silver, black or champagne coated aluminum. Further surface options see Lightnet-Surface-Collection or RAL of your choice. LED Engine with XICATO ARTIST for highest light quality and colour rendering (CRI>97), including 5-year warranty for colour consistency (MacAdam \leq 3) or ECO for highest energy efficiency with optimal price performance ratio and CRI> 90. Colour temperature 2700K, 3000K or 4000K. Replaceable lens reflector optic with spherical faceted optic. Beam angle: 10° (Spot), 20° (Medium), 35° (Flood) or 50° (Wide Flood). Reflector ring available in different colour versions. Standard clear cover. Optional additional filters or honeycomb louvre.

PM6BSE-927FM-BK

Product Family	P: Midpoint
Type	M6: Direct only
Beam Angle	A: Spot 10°, B: Medium 20°, C: Flood 35°, D: Wide Flood 50°
Surface Finish	W: Snow White, V: Ivory White, S: Radiant Silver, B: Jet Black, H: Anodic Champagne
Control Gear	E: On/Off, L: DALI, H: Touch-Dim
Colour Rendering	9: CRI>90
Colour Temperature	27: 2700K, 30: 3000K, 40: 4000K
Led-Engine	F: Eco [Ra> 90], A: Artist [Ra> 97, Xicato]
Power	E: Low Power M: Medium Power
Optic Ring	W: Snow White, V: Ivory White, S: Radiant Silver, B: Jet Black, H: Anodic Champagne, G: Satin Gold, K: Satin Copper
Cover	K: Clear Cover [Standard], P: Prismatic Lens, H: Honeycomb Louvre
On Request	Optic Removal Tool for clear cover



Spot 10° Led Engine Eco, Medium Power

Mounting Height	Illuminance[Lux] center/side	Beam Diameter
1 m	25250/12700	0.24 m
2 m	6312/3175	0.48 m
3 m	2806/1411	0.72 m
4 m	1578/794	0.95 m

LED Engine	2700K	3000K	4000K
Eco Low Power [19W]	1230 lm	1350 lm	1440 lm
Eco Medium Power [31W]	1660 lm	1860 lm	2020 lm
Artist Low Power [19W]	1040 lm	1090 lm	1190 lm
Artist Medium Power [31W]	1400 lm	1480 lm	1560 lm

Medium 20° Led Engine Eco, Medium Power

Mounting Height	Illuminance[Lux] center/side	Beam Diameter
1 m	17447/8455	0.32 m
2 m	4362/2114	0.64 m
3 m	1939/939	0.96 m
4 m	1090/528	1.30 m

LED Engine	2700K	3000K	4000K
Eco Low Power [19W]	1580 lm	1740 lm	1850 lm
Eco Medium Power [31W]	2360 lm	2640 lm	2870 lm
Artist Low Power [19W]	1330 lm	1390 lm	1510 lm
Artist Medium Power [31W]	1980 lm	2110 lm	2220 lm

Flood 35° Led Engine Eco, Medium Power

Mounting Height	Illuminance[Lux] center/side	Beam Diameter
1 m	6251/2731	0.63 m
2 m	1563/683	1.30 m
3 m	695/303	1.90 m
4 m	391/171	2.50 m

LED Engine	2700K	3000K	4000K
Eco Low Power [19W]	1530 lm	1680 lm	1790 lm
Eco Medium Power [31W]	2280 lm	2550 lm	2780 lm
Artist Low Power [19W]	1290 lm	1350 lm	1470 lm
Artist Medium Power [31W]	1930 lm	2060 lm	2160 lm

Wide Flood 50° Led Engine Eco, Medium Power

Mounting Height	Illuminance[Lux] center/side	Beam Diameter
1 m	3550/1319	0.94 m
2 m	887/330	1.90 m
3 m	394/147	2.80 m
4 m	222/82	3.80 m

LED Engine	2700K	3000K	4000K
Eco Low Power [19W]	1440 lm	1580 lm	1680 lm
Eco Medium Power [31W]	2230 lm	2490 lm	2710 lm
Artist Low Power [19W]	1250 lm	1310 lm	1430 lm
Artist Medium Power [31W]	1910 lm	2040 lm	2140 lm



Basic L7 | Superflat Semi-Recessed



DE LED-Halbeinbauleuchte für gesägte Deckenöffnungen. Rein direktstrahlend. Umlaufender Einbaurahmen aus Aluminium mit lediglich 18mm sichtbarer Bauhöhe. 5 verschiedene Durchmesser von 300 bis 800mm. Oberfläche weiß, silber, graphit, schwarz, champagner oder kupferfarben lackiert. Weitere Oberflächenoptionen siehe Lightnet-Surface-Collection oder RAL nach Wahl. Microprismenoptik mit optimierter Blendungsbegrenzung speziell für Office-Anwendungen. Satinierter Opaldiffusor für Allgemeinbeleuchtung mit max. Transmissionsgrad und homogener Lichtpunktauflösung. Konverter in Leuchtengehäuse integriert, wahlweise einfach schaltbar oder stufenlos dimmbar (DALI, Touch-Dim, Casambi). Farbtemperaturen 2200K, 2700K, 3000K, 3500K, 4000K, 6500K oder Tunable White. Binning initial \leq MacAdam 3. Farbwiedergabe CRI $>$ 80, CRI $>$ 90 oder Full Spectrum. Befestigungsset zur Montage inklusive. Auf Anfrage: Integration von Notlichtkomponenten, Sensortechnologie.

EN Semi Recessed LED luminaire for ceilings with cut-out openings. Direct only light distribution. Surrounding mounting frame with 18mm trim overall height. 5 different diameters from 300 to 800mm. Surface white, silver, graphite, black, champagne or copper coated. Further surface options see Lightnet-Surface-Collection or RAL of your choice. Microprismatic screen with optimized glare reduction especially for workplaces. Satin opal diffuser for general lighting with maximum transmittance and homogeneous lighting. Driver integrated into luminaire housing, optionally switchable or dimmable (DALI, Touch-Dim, Casambi). Colour temperature 2200K, 2700K, 3000K, 3500K, 4000K, 6500K or Tunable White. Binning \leq MacAdam 3. Colour rendering CRI $>$ 80, CRI $>$ 90 or Full Spectrum. Mounting brackets for assembly included. On request: Integration of emergency lighting components, sensor technology.

B L7 A S L-8 30 M-D300

- Product Family **B:** Basic
- Type **L7:** Direct only
- Optical System **A:** Microprismatic, **O:** Opal Diffuser
- Surface Finish **W:** Snow White, **V:** Ivory White, **S:** Radiant Silver, **U:** Urban Graphite, **B:** Jet Black, **H:** Anodic Champagne, **K:** Satin Copper
- Control Gear **E:** On/Off, **L:** DALI, **H:** Touch-Dim, **C:** Casambi, **6:** DALI DT6 for TW, **8:** DALI DT8 for TW
- Colour Rendering **8:** CRI>80, **9:** CRI>90, **F:** Full Spectrum [except 2200K]
- Colour Temperature **22:** 2200K, **27:** 2700K, **30:** 3000K, **35:** 3500K, **40:** 4000K, **65:** 6500K, **TW:** Tunable White 2700-6500K [D400-D800]
- Power **M:** Medium Power, **H:** High Power
- Size Luminaire Diameter in mm: **D300, D400, D500, D600, D800**
- On Request Multisensor [D400-D800], Radar Sensor, Emergency Module [D400-D800]



Microprismatic | Direct

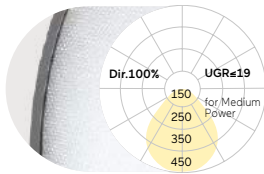

Opal Diffuser | Direct

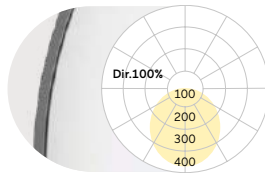

D mm	Lumen/Watt Medium Power	Lumen/Watt High Power
300	690lm/7W	1190lm/11W
400	1470lm/12W	2560lm/21W
500	2030lm/16W	3570lm/28W
600	3390lm/25W	5520lm/42W
800	5160lm/40W	6980lm/54W

D mm	Lumen/Watt Medium Power	Lumen/Watt High Power
300	700lm/7W	1200lm/11W
400	1490lm/12W	2580lm/21W
500	2070lm/16W	3630lm/28W
600	3460lm/25W	5620lm/42W
800	5280lm/40W	7150lm/54W

Lumen Values: Luminaire luminous flux at 4000K/CRI>80. Other configurations on request.

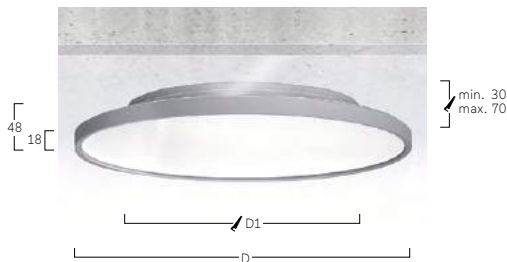

Cut-Out

D[mm]	300	400	500	600	800
D1[mm]	230	320	410	490	670



Multisensor



Emergency Module



W Snow White



S Radiant Silver



U Urban Graphite



B Jet Black



H Anodic Champagne



K Satin Copper

Basic Déco N3 | Recessed Frameless



DE LED-Einbauleuchte für rahmenlose Montage in Gipskartondecken. Direktstrahlend mit indirekter Lichtkorona. Leuchtenkörper aus Aluminium. 4 verschiedene Durchmesser von 300 bis 600mm. Gehäuse-Außenfläche und Innendekor in unterschiedlichen Lackierungen und Kombinationen erhältlich, z.B. weiß, silber, graphit, schwarz, gold oder kupferfarben. Zu Oberflächenoptionen- und Kombinationen siehe Lightnet-Surface-Collection oder Bi-Colour-Auswahl. Rückversetzte Microprismenoptik mit optimierter Blendungsbegrenzung speziell für Office-Anwendungen. Satinierter Opaldiffusor für Allgemeinbeleuchtung mit max. Transmissionsgrad und homogener Lichtpunktauflösung. Konverter in Leuchtengehäuse integriert, wahlweise einfach schaltbar oder stufenlos dimmbar (DALI, Touch-Dim, Casambi). Farbtemperatur 2200K, 2700K, 3000K, 3500K, 4000K, 6500K oder Tunable White (2700-6500K). Indirekte Lichtkorona wahlweise in Farbtemperatur der Leuchte oder alternativ andersfarbig in rot, grün, blau oder magenta. Binning initial \leq MacAdam 3. Farbwiedergabe CRI>80, CRI>90 oder Full Spectrum. Befestigungsset zur Montage inklusive. Auf Anfrage: Integration von Notlichtkomponenten.

EN Recessed mounted LED luminaire for frameless installation in plasterboard ceilings. Direct and indirect light distribution. Luminaire body made of aluminium. 4 different diameters from 300 to 600mm. Outer housing and inner decor available in various finishes and combinations, e.g. white, silver, graphite, black, gold or copper coated. For further surface options see Lightnet-Surface-Collection or RAL of your choice. Recessed microprismatic screen with optimized glare reduction especially for workplaces. Satin opal diffuser for general lighting with maximum transmittance and homogeneous lighting. Driver integrated into luminaire housing, optionally switchable or dimmable (DALI, Touch-Dim, Casambi). Colour temperature 2200K, 2700K, 3000K, 3500K, 4000K, 6500K or Tunable White (2700-6500K). Indirect lighting corona optionally in colour temperature of luminaire or alternatively in different colours: red, green, blue or magenta. Binning \leq MacAdam 3. Colour rendering CRI>80, CRI>90 or Full Spectrum. Mounting brackets for assembly included. On request: Integration of emergency lighting components.

B N3 A W E-8 30 M- D300-GW

Product Family	B: Basic
Type	N3: Direct with Indirect Light Corona
Optical System	A: Microprismatic, O: Opal Diffuser
Surface Finish	W: Snow White, V: Ivory White, S: Radiant Silver, U: Urban Graphite, B: Jet Black, H: Anodic Champagne, K: Satin Copper
Control Gear	E: On/Off, L: DALI, H: Touch-Dim, C: Casambi
Colour Rendering	8: CRI>80, 9: CRI>90, F: Full Spectrum [except 2200K]
Colour Temperature	22: 2200K, 27: 2700K, 30: 3000K, 35: 3500K, 40: 4000K, 65: 6500K
Power	M: Medium Power, H: High Power
Size	Luminaire Diameter in mm: D300, D400, D500, D600
Reflector	W: Snow White, V: Ivory White, S: Radiant Silver, U: Urban Graphite, B: Jet Black, H: Anodic Champagne, K: Satin Copper, G: Satin Gold
Aura Colour	R: Red, G: Green, B: Blue, M: Magenta, W: White



Microprismatic | Direct with Indirect Light Corona

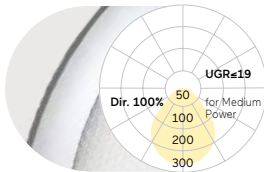

Opal Diffuser | Direct with Indirect Light Corona

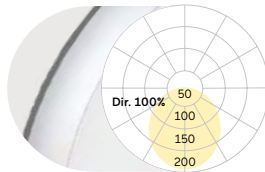

D mm	Lumen/Watt		D mm	Lumen/Watt	
	Medium Power	High Power		Medium Power	High Power
300	990lm/14W	1720lm/23W	300	970lm/14W	1690lm/23W
400	1830lm/24W	2920lm/37W	400	1830lm/24W	2920lm/37W
500	2800lm/36W	4620lm/41W	500	2820lm/36W	4670lm/41W
600	4020lm/44W	5910lm/65W	600	4110lm/44W	6010lm/65W

Lumen Values: Luminaire luminous flux at 4000K/CRI>80. Other configurations on request.

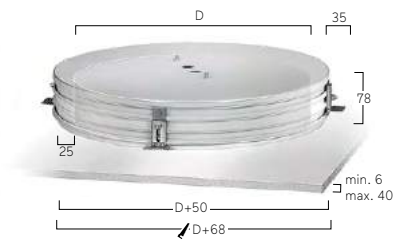

W Snow White
W Snow White



S Radiant Silver
S Radiant Silver



U Urban Graphite
U Urban Graphite



B Jet Black
B Jet Black



H Anodic Champagne
H Anodic Champagne



K Satin Copper
K Satin Copper

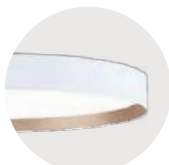

W Snow White
K Satin Copper

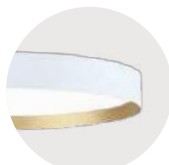

W Snow White
G Satin Gold



W Snow White
B Jet Black



H Anodic Champagne
B Jet Black



B Jet Black
G Satin Gold

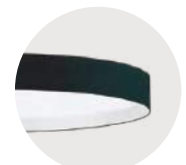

B Jet Black
W Snow White

Basic Déco L3 | Recessed Frame



DE LED-Einbauleuchte für gesägte Deckenöffnungen. Rein direktstrahlend. Leuchtenkörper aus Aluminium. 5 verschiedene Durchmesser von 330 bis 990mm. Außenrahmen und dekorativer Reflektorring in unterschiedlichen Lackierungen und Kombinationen erhältlich, z.B. weiß, silber, graphit, schwarz, gold oder kupferfarben. Zu Oberflächenoptionen- und Kombinationen siehe Lightnet-Surface-Collection. Rückversetzte Microprismenoptik mit optimierter Blendungsbegrenzung speziell für Office-Anwendungen. Satiniertes Opaldiffusor für Allgemeinbeleuchtung mit max. Transmissionsgrad und homogener Lichtpunktauflösung. Konverter in Leuchtengehäuse integriert, wahlweise einfach schaltbar oder stufenlos dimmbar (DALI, Touch-Dim, Casambi). Farbtemperatur 2200K, 2700K, 3000K, 3500K, 4000K, 6500K oder Tunable White (2700-6500K). Binning initial \leq MacAdam 3. Farbwiedergabe CRI $>$ 80, CRI $>$ 90 oder Full Spectrum. Befestigungsset zur Montage inklusive. Auf Anfrage: Integration von Notlichtkomponenten.

EN Recessed mounted LED luminaire for ceilings with cut-out openings. Direct only light distribution. Luminaire body made of aluminium. 5 different diameters from 330 to 990mm. Outer frame and decorative reflector ring available in various finishes and combinations, e.g. white, silver, graphite, black, gold or copper coated. For surface options and combinations check Lightnet Surface Collection. Recessed microprismatic screen with optimized glare reduction especially for workplaces. Satin opal diffuser for general lighting with maximum transmittance and homogeneous lighting. Driver integrated into luminaire housing, optionally switchable or dimmable (DALI, Touch-Dim, Casambi). Colour temperature 2200K, 2700K, 3000K, 3500K, 4000K, 6500K or Tunable White (2700-6500K). Binning \leq MacAdam 3. Colour rendering CRI $>$ 80, CRI $>$ 90 or Full Spectrum. Mounting brackets for assembly included. On request: Integration of emergency lighting components.

B L3 A W E-8 30 M- D330 -G

- Product Family **B:** Basic
- Type **L3:** Direct Only
- Optical System **A:** Microprismatic [D330-D680], **O:** Opal Diffuser
- Surface Finish **W:** Snow White, **V:** Ivory White, **S:** Radiant Silver, **U:** Urban Graphite, **B:** Jet Black, **H:** Anodic Champagne, **K:** Satin Copper
- Control Gear **E:** On/Off, **L:** DALI, **H:** Touch-Dim, **C:** Casambi, **6:** DALI DT6 for TW, **8:** DALI DT8 for TW
- Colour Rendering **8:** CRI>80, **9:** CRI>90, **F:** Full Spectrum [except 2200K]
- Colour Temperature **22:** 2200K, **27:** 2700K, **30:** 3000K, **35:** 3500K, **40:** 4000K, **65:** 6500K, **TW:** Tunable White 2700-6500K [D430-D990]
- Power **E:** Low Power, **M:** Medium Power
- Size Luminaire Diameter in mm: **D330, D430, D530, D680, D990**
- Reflector **W:** Snow White, **V:** Ivory White, **S:** Radiant Silver, **U:** Urban Graphite, **B:** Jet Black, **H:** Anodic Champagne, **K:** Satin Copper, **G:** Satin Gold
- On Request Radar Sensor, Emergency Module



Microprismatic | Direct

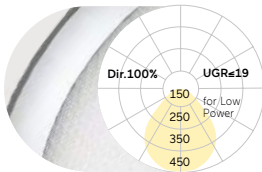

Opal Diffuser | Direct

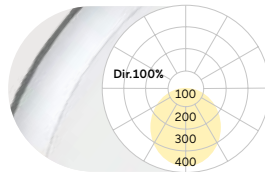

D mm	Lumen/Watt		D mm	Lumen/Watt	
	Low Power	Medium Power		Low Power	Medium Power
330	880lm/8W	1730lm/14W	330	910lm/8W	1780lm/14W
430	1740lm/13W	3580lm/29W	430	1790lm/13W	3690lm/29W
530	2480lm/18W	4860lm/35W	530	2550lm/18W	5010lm/35W
680	3860lm/28W	7250lm/52W	680	3980lm/28W	7470lm/52W
			990	7000lm/59W	11830lm/106W

Lumen Values: Luminaire luminous flux at 4000K/CRI>80. Other configurations on request.



Basic Recessed



My Spa, Mainz, Germany
Basic M2, Basic Y1



Centre for Integrated Oncology University Hospital
Cologne, Germany
Basic M4
Photography: Tomas Rodriguez
Planning: corinna arens and dorette faulhaber

Basic Max M2 | Recessed Frameless



DE LED-Einbauleuchte für rahmenlose Montage in Gipskartondecken. Rein direktstrahlend. Leuchtenkörper aus Aluminium. 5 verschiedene Durchmesser von 300 bis 950mm. Microprismenoptik mit optimierter Blendungsbegrenzung speziell für Office-Anwendungen. Satinierter Opaldiffusor für Allgemeinbeleuchtung mit max. Transmissionsgrad und homogener Lichtpunktauflösung. Konverter in Leuchtengehäuse integriert, wahlweise einfach schaltbar oder stufenlos dimmbar (DALI, Touch-Dim, Casambi). Farbtemperaturen 2200K, 2700K, 3000K, 3500K, 4000K 6500K oder Tunable White. Binning initial \leq MacAdam 3. Farbwiedergabe CRI $>$ 80, CRI $>$ 90 oder Full Spectrum. Befestigungsset zur Montage inklusive. Installationshilfe zur Sicherstellung ordnungsgemäßer Montage empfohlen (s. Zubehör, separat zu ordern). Nicht geeignet für Wandinstallation. Auf Anfrage: Integration von Notlichtkomponenten, Sensortechnologie.

EN Recessed mounted LED luminaire for frameless installation in plasterboard ceilings. Direct only light distribution. Luminaire body made of aluminium. 5 different diameters from 300 to 950mm. Microprismatic screen with optimized glare reduction especially for workplaces. Satin opal diffuser for general lighting with maximum transmittance and homogeneous lighting. Driver integrated into luminaire housing, optionally switchable or dimmable (DALI, Touch-Dim, Casambi). Colour temperature 2200K, 2700K, 3000K, 3500K, 4000K, 6500K or Tunable White. Binning \leq MacAdam 3. Colour rendering CRI $>$ 80, CRI $>$ 90 or Full Spectrum. Mounting brackets for assembly included. Mounting template for correct installation is recommended (see accessories, to be ordered eparately). Vertical Installation not possible. On request: Integration of emergency lighting components, sensor technology.

B M2 A W E- 8 30 M-D300

- Product Family **B:** Basic
- Type **M2:** Direct only
- Optical System **A:** Microprismatic [D300-D650], **O:** Opal Diffuser
- Surface Finish **W:** Snow White
- Control Gear **E:** On/Off, **L:** DALI, **H:** Touch-Dim, **C:** Casambi, **6:** DALI DT6 for TW, **8:** DALI DT8 for TW
- Colour Rendering **8:** CRI>80, **9:** CRI>90, **F:** Full Spectrum [except 2200K]
- Colour Temperature **22:** 2200K, **27:** 2700K, **30:** 3000K, **35:** 3500K, **40:** 4000K, **65:** 6500K, **TW:** Tunable White 2700-6500K
- Power **E:** Low Power, **M:** Medium Power
- Size Luminaire Diameter in mm: **D300, D400, D500, D650, D950**
- On Request Radar Sensor, Emergency Module



Microprismatic | Direct

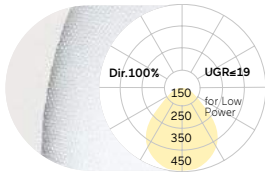

Opal Diffuser | Direct

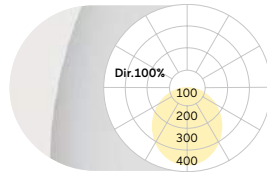

D mm	Lumen/Watt		D mm	Lumen/Watt	
	Low Power	Medium Power		Low Power	Medium Power
300	880lm/8W	1730lm/14W	300	910lm/8W	1780lm/14W
400	1740lm/13W	3580lm/29W	400	1790lm/13W	3690lm/29W
500	2480lm/18W	4860lm/35W	500	2550lm/18W	5010lm/35W
650	3860lm/28W	7250lm/52W	650	3980lm/28W	7470lm/52W
			950	7000lm/59W	11830lm/106W

Lumen Values: Luminarie luminous flux at 4000K/CRI>80. Other configurations on request.

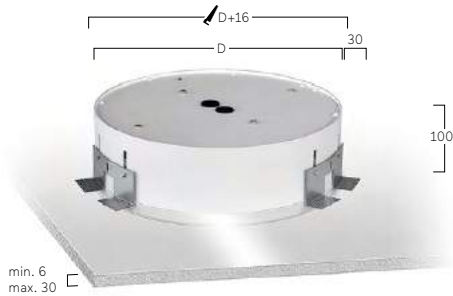

Please order separately

Type	Code
WT for Basic-M2/Ø300	BM2-WT-300
WT for Basic-M2/Ø400	BM2-WT-400
WT for Basic-M2/Ø500	BM2-WT-500
WT for Basic-M2/Ø650	BM2-WT-650
WT for Basic-M2/Ø950	BM2-WT-950



Installation Template

Basic Max M4 | Recessed Frame



DE LED-Einbauleuchte für gesägte Deckenöffnungen. Rein direktstrahlend. Leuchtenkörper mit umlaufendem Rahmen aus Aluminium. 7 verschiedene Durchmesser von 220 bis 1250mm. Oberfläche weiß, silber, graphit, schwarz, champagner oder kupferfarben lackiert. Weitere Oberflächenoptionen siehe Lightnet-Surface-Collection oder RAL nach Wahl. Microprismenoptik mit optimierter Blendungsbegrenzung speziell für Office-Anwendungen. Satinierter Opaldiffusor für Allgemeinbeleuchtung mit max. Transmissionsgrad und homogener Lichtpunktauflösung. Konverter in Leuchtgehäuse integriert, wahlweise einfach schaltbar oder stufenlos dimmbar (DALI, Touch-Dim, Casambi). Farbtemperaturen 2200K, 2700K, 3000K, 3500K, 4000K oder 6500K. Binning initial \leq MacAdam 3. Farbwiedergabe CRI $>$ 80, CRI $>$ 90 oder Full Spectrum. Befestigungsset zur Montage inklusive. Nicht geeignet für Wandinstallation. Auf Anfrage: Integration von Notlichtkomponenten.

EN Recessed mounted LED luminaire for ceilings with cut-out openings. Direct only light distribution. Luminaire body with surrounding frame made of aluminium. 7 different diameters from 220 to 1250mm. Surface white, silver, graphite, black, champagne or copper coated. Further surface options see Lightnet-Surface-Collection or RAL of your choice. Microprismatic screen with optimized glare reduction especially for workplaces. Satin opal diffuser for general lighting with maximum transmittance and homogeneous lighting. Driver integrated into luminaire housing, optionally switchable or dimmable (DALI, Touch-Dim, Casambi). Colour temperature 2200K, 2700K, 3000K, 3500K, 4000K or 6500K. Binning \leq MacAdam 3. Colour rendering CRI $>$ 80, CRI $>$ 90 or Full Spectrum. Mounting brackets for assembly included. Vertical Installation not possible. On request: Integration of emergency lighting components.

B M4 A U E-8 30 M-D320

- Product Family **B:** Basic
- Type **M4:** Direct only
- Optical System **A:** Microprismatic [D220-D670], **O:** Opal Diffuser
- Surface Finish **W:** Snow White, **V:** Ivory White, **S:** Radiant Silver, **U:** Urban Graphite, **B:** Jet Black, **H:** Anodic Champagne, **K:** Satin Copper
- Control Gear **E:** On/Off, **L:** DALI, **H:** Touch-Dim, **C:** Casambi [D320-D1250], **6:** DALI DT6 for TW, **8:** DALI DT8 for TW
- Colour Rendering **8:** CRI>80, **9:** CRI>90, **F:** Full Spectrum [except 2200K]
- Colour Temperature **22:** 2200K, **27:** 2700K, **30:** 3000K, **35:** 3500K, **40:** 4000K, **65:** 6500K, **TW:** Tunable White 2700-6500K [D320-D1250]
- Power **E:** Low Power, **M:** Medium Power
- Size Luminaire Diameter in mm: **D220, D320, D420, D520, D670, D980, D1250**
- On Request Radar Sensor [D320-D1250], Emergency Module [D320-D1250]



Microprismatic | Direct

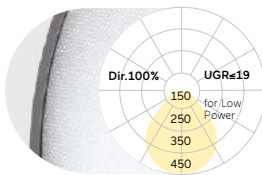

Opal Diffuser | Direct

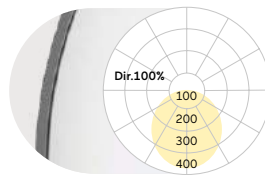

D mm	Lumen/Watt		D mm	Lumen/Watt	
	Low Power	Medium Power		Low Power	Medium Power
220	450lm/5W	1110lm/10W	220	470lm/5W	1160lm/10W
320	880lm/8W	1730lm/14W	320	910lm/8W	1780lm/14W
420	1740lm/13W	3580lm/29W	420	1790lm/13W	3690lm/29W
520	2480lm/18W	4860lm/35W	520	2550lm/18W	5010lm/35W
670	3860lm/28W	7250lm/52W	670	3980lm/28W	7470lm/52W
			980	7000lm/59W	11830lm/106W
			1250	12250lm/107W	20700lm/195W

Lumen Values: Luminaire luminous flux at 4000K/CRI>80. Other configurations on request.

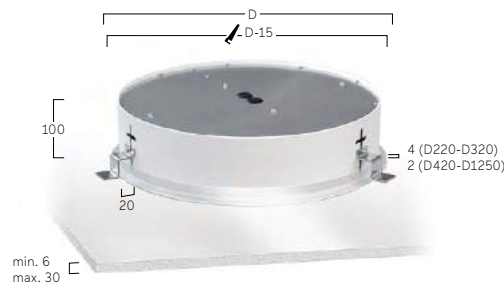

min. 6
max. 30

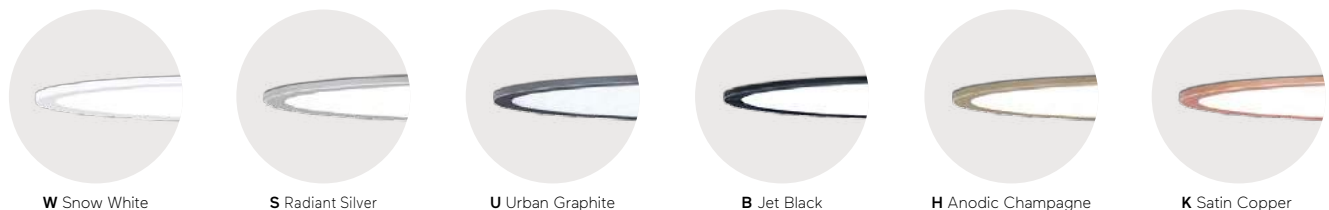

Basic Visio L9 | Semi-Recessed



DE LED-Halbeinbauleuchte für gesägte Deckenöffnungen. Direkt- rundumstrahlend für dezente Wand- bzw. Deckenaufhellung. 4 verschiedene Durchmesser von 320 bis 630mm. Leuchtenkörper mit umlaufendem Rahmen aus Aluminium wahlweise weiß oder graphitfarben. Optikträger aus gegossenem Acrylglas. Wahlweise Microprismenoptik mit optimierter Blendungsbegrenzung speziell für Office-Anwendungen oder satiniertes Opaldiffusor für Allgemeinbeleuchtung mit max. Transmissionsgrad und homogener Lichtpunktauflösung. Konverter in Leuchtengehäuse integriert, wahlweise einfach schaltbar oder stufenlos dimmbar (DALI, Touch-Dim, Casambi). Farbtemperatur 2200K, 2700K, 3000K, 3500K, 4000K, 6500K oder Tunable White (2700-6500K). Binning initial: MacAdam 3. Farbwiedergabe CRI>80, CRI>90 oder Full Spectrum. Befestigungsset zur Montage inklusive. Auf Anfrage: Integration von Notlichtkomponenten.

EN Semi Recessed LED luminaire for ceilings with cut-out openings. Omnidirectional light distribution for soft wall or ceiling illumination. 4 different diameters from 320 to 630mm. Luminaire body with surrounding frame made of aluminium optionally white or graphite coated. Luminaire body made of cast acrylic glass. Available with microprismatic screen with optimized glare reduction especially for workplaces or satin opal diffuser for general lighting with maximum transmittance and homogeneous lighting. Driver integrated into luminaire housing, optionally switchable or dimmable (DALI, Touch-Dim, Casambi). Colour temperature 2200K, 2700K, 3000K, 3500K, 4000K, 6500K or Tunable White (2700-6500K). Binning \leq MacAdam 3. Colour rendering CRI>80, CRI>90 or Full Spectrum. Mounting brackets for assembly included. On request: Integration of emergency lighting components.

B L9 O W E-8 30 M- D420

- Product Family **B**: Basic
- Type **L9**: Direct Only
- Optical System **A**: Microprismatic, **O**: Opal Diffuser
- Surface Finish **W**: Snow White, **V**: Ivory White, **S**: Radiant Silver, **U**: Urban Graphite, **B**: Jet Black, **H**: Anodic Champagne, **K**: Satin Copper
- Control Gear **E**: On/Off, **L**: DALI, **H**: Touch-Dim, **C**: Casambi, **6**: DALI DT6 for TW, **8**: DALI DT8 for TW
- Colour Rendering **8**: CRI>80, **9**: CRI>90, **F**: Full Spectrum [except 2200K]
- Colour Temperature **22**: 2200K, **27**: 2700K, **30**: 3000K, **35**: 3500K, **40**: 4000K, **65**: 6500K, **TW**: Tunable White 2700-6500K
- Power **M**: Medium Power, **H**: High Power
- Size Luminaire Diameter in mm: **D320**, **D420**, **D520**, **D630**
- On Request Emergency Module [D420-D630]



Microprismatic | Direct

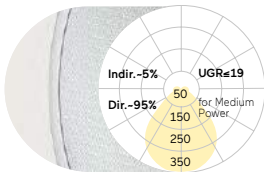

Opal Diffuser | Direct

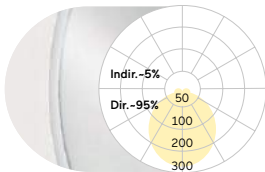

D mm	Lumen/Watt		D mm	Lumen/Watt	
	Medium Power	High Power		Medium Power	High Power
320	630lm/5W	1000lm/9W	320	670lm/5W	1060lm/9W
420	1630lm/13W	2840lm/22W	420	1730lm/13W	3020lm/22W
520	2470lm/19W	4560lm/34W	520	2620lm/19W	4830lm/34W
630	3340lm/25W	6200lm/46W	630	3550lm/25W	6570lm/46W

Lumen Values: Luminaire luminous flux at 4000K/CRI>80. Other configurations on request.

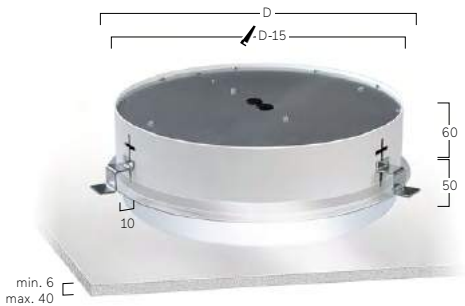

W Snow White

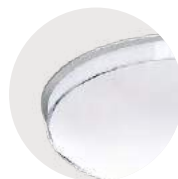

S Radiant Silver

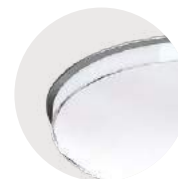

U Urban Graphite

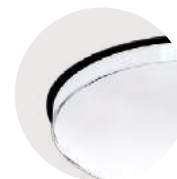

B Jet Black

Ringo Star F5 | Compact Recessed Frame



DE LED-Einbauleuchte für gesägte Deckenöffnungen. Rein direktstrahlend. Leuchtenkörper mit umlaufendem Rahmen aus Aluminium. Kompakte Ausführung mit innenliegendem Blindelement. Optikbreite 40mm. 3 verschiedene Durchmesser (Ø210, Ø280, Ø380). Oberfläche weiß, silber, graphit, schwarz, champagner oder kupferfarben lackiert. Weitere Oberflächenoptionen siehe Lightnet-Surface-Collection oder RAL nach Wahl. Direktanteil über Präzisionslinsen mit Abblenderaster für breite rotationssymmetrische Lichtstärkeverteilung bei gleichzeitig hoher Blendungsbegrenzung (UGR<19) speziell für Office Anwendungen. Abblenderaster in verschiedenen Farbkombinationen erhältlich. Konverter im zentralen Blindelement integriert, wahlweise einfach schaltbar oder stufenlos dimmbar (DALI, Touch-Dim). Farbtemperatur 2200K, 2700K, 3000K, 3500K, 4000K oder 6500K. Binning initial \leq MacAdam 3. Farbwiedergabe CRI>80, CRI>90 oder Full Spectrum. Befestigungsset zur Montage inklusive. Auf Anfrage: Integration von Sensortechnologie, Lüftungsauslässen, Lautsprechern, Überwachungskameras und zusätzlichen Downlights im zentralen Blindelement.

EN Recessed mounted LED luminaire for ceilings with cut-out openings. Direct only light distribution. Luminaire body with surrounding frame made of aluminium. Compact version with internal blind element. Optics width 40mm. 3 different diameters (Ø210, Ø280, Ø380). Surface white, silver, graphite, black, champagne or copper coated. Further surface options see Lightnet-Surface-Collection or RAL of your choice. Direct light using precision lenses with louvre for wide uniform symmetrical light distribution with high glare limitation (UGR<19) especially for workplaces. Louvre available in various colour finishes. Driver integrated into central blank plate, optionally switchable or dimmable (DALI, Touch-Dim). Colour temperature 2200K, 2700K, 3000K, 3500K, 4000K or 6500K. Binning \leq MacAdam 3. Colour rendering CRI>80, CRI>90 or Full Spectrum. Mounting brackets for assembly included. On request: Integration of sensor technology, ventilation outlets, loudspeakers, surveillance cameras and additional downlights in the central blind element.

R F5 L WE-8 30 H-D200- W-MP

Product Family	R: Ringo Star
Type	F5: Direct only
Optical System	L: Lens Louvre
Surface Finish	W: Snow White, V: Ivory White, A: Satin Silver, S: Radiant Silver, U: Urban Graphite, B: Jet Black, H: Anodic Champagne, K: Satin Copper
Control Gear	E: On/Off, L: DALI, H: Touch-Dim
Colour Rendering	8: CRI>80, 9: CRI>90, F: Full Spectrum [except 2200K]
Colour Temperature	22: 2200K, 27: 2700K, 30: 3000K, 35: 3500K, 40: 4000K, 65: 6500K
Power	E: Low Power, H: High Power
Size	Luminaire Length in mm: D200, D270, D370
Lens Louvre	W: Snow White, A: Satin Silver, B: Jet Black, H: Anodic Champagne, K: Satin Copper, G: Satin Gold
Central Module	For D200: BP: Blind Plate, EM: Emergency Module** **, MP: Midpin Spotlight** **, MM: Multisensor** ** For D270: BP: Blind Plate, EM: Emergency Module** **, MP: Midpin Spotlight** **, AS: Air Supply** **, MM: Multisensor** ** For D370: BP: Blind Plate, EM: Emergency Module** **, MP: Midpin Spotlight** **, AS: Air Supply** **, MM: Multisensor** **
On Request	Casambi, Camera, Speaker (white or black) * Please specify type ** With external drivers



Lens Louvre | Direct

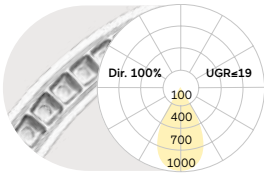

D mm	Lumen/Watt Low Power	Lumen/Watt High Power
200	1570lm/13W	2660lm/23W
270	1860lm/15W	3110lm/26W
370	2480lm/20W	4140lm/34W

Lumen Values: Luminaire luminous flux at 4000K/CRI>80. Other configurations on request.

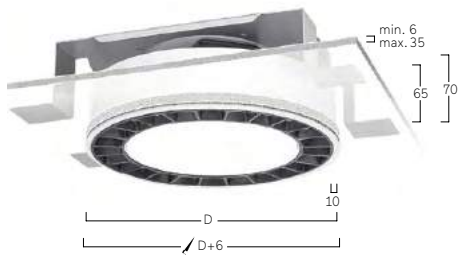

BP Blind Plate



Midpin Spotlight XD
770lm/10W/Ø40mm



EM Emergency Module



MM Multisensor



AS Air Supply



Speaker (white or black)



Camera



W Snow White
W Snow White



W Snow White
A Satin Silver



W Snow White
B Jet Black



W Snow White
G Satin Gold



W Snow White
H Anodic Champagne



W Snow White
K Satin Copper

Ringo Star FX | System 40mm Recessed Frame



DE LED-Einbauleuchte für gesägte Deckenöffnungen. Rein direktstrahlend. Leuchtenkörper mit umlaufendem Rahmen aus Aluminiumprofil. Optikbreite 40mm. 5 verschiedene Durchmesser von 600mm bis 2000mm. Oberfläche weiß, silber, graphit, schwarz, champagner oder kupferfarben lackiert. Weitere Oberflächenoptionen siehe Lightnet-Surface-Collection oder RAL nach Wahl. Direktanteil über Präzisionslinsen mit Abblenderaster (Ø610-Ø1255) für breite rotationssymmetrische Lichtstärkeverteilung bei gleichzeitig hoher Blendungsbegrenzung (UGR<19) speziell für Office Anwendungen. Abblenderaster in verschiedenen Farbkombinationen erhältlich. Satiniertes Opaldiffusor für Allgemeinbeleuchtung mit max. Transmissionsgrad und homogener Lichtpunktauflösung. Konverter in Leuchtgehäuse integriert, wahlweise einfach schaltbar oder stufenlos dimmbar (DALI, Touch-Dim, Casambi). Farbtemperatur 2200K, 2700K, 3000K, 3500K, 4000K oder 6500K. Binning initial \leq MacAdam 3. Farbwiedergabe CRI>80, CRI>90 oder Full Spectrum. Befestigungsset zur Montage inklusive.

EN Recessed mounted LED luminaire for ceilings with cut-out openings. Direct only light distribution. Luminaire body with surrounding frame made of aluminium profile. Optic width 40mm. 5 different diameters from 600mm to 2000mm. Surface white, silver, graphite, black, champagne or copper coated. Further surface options see Lightnet-Surface-Collection or RAL of your choice. Direct light using precision lenses with louvre (Ø610-Ø1255) for wide uniform symmetrical light distribution with high glare limitation (UGR<19) especially for workplaces. Louvre available in various colour finishes. Satin opal diffuser for general lighting with maximum transmittance and homogeneous lighting. Driver integrated into luminaire housing, optionally switchable or dimmable (DALI, Touch-Dim, Casambi). Colour temperature 2200K, 2700K, 3000K, 3500K, 4000K or 6500K. Binning \leq MacAdam 3. Colour rendering CRI>80, CRI>90 or Full Spectrum. Mounting brackets for assembly included.

R FX L WE-8 30 E - D610 - B*

Product Family	R: Ringo Star
Type	FX: Direct only
Optical System	C: Opal Flex Diffuser, L: Lens Louvre [D610-D1255]
Surface Finish	W: Snow White, V: Ivory White, A: Satin Silver, S: Radiant Silver, U: Urban Graphite, B: Jet Black, H: Anodic Champagne, K: Satin Copper
Control Gear	E: On/Off, L: DALI, C: Casambi, H: Touch-Dim
Colour Rendering	8: CRI>80, 9: CRI>90, F: Full Spectrum [except 2200K]
Colour Temperature	22: 2200K, 27: 2700K, 30: 3000K, 35: 3500K, 40: 4000K, 65: 6500K
Power	E: Low Power, M: Medium Power, H: High Power
Size	Luminaire Diameter in mm: D610, D910, D1255, D1510, D2010
Lens Louvre*	W: Snow White, A: Satin Silver, B: Jet Black, H: Anodic Champagne, K: Satin Copper, G: Satin Gold



Lens Louvre | Direct

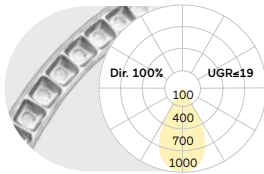

Opal Flex Diffuser | Direct

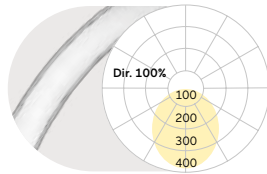

D mm	Lumen/Watt Low Power	Lumen/Watt High Power
610	2850lm/23W	5170lm/42W
910	4350lm/33W	7980lm/66W
1255	6090lm/45W	11170lm/90W

D mm	Lumen/Watt Medium Power	Lumen/Watt High Power
610	2680lm/29W	3740lm/41W
910	4030lm/43W	5610lm/62W
1255	5820lm/62W	7940lm/89W
1510	6730lm/71W	9920lm/108W
2010	9400lm/100W	13210lm/144W

Lumen Values: Luminaire luminous flux at 4000K/CRI>80. Other configurations on request.

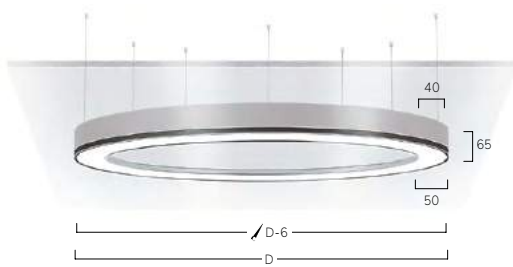

W Snow White
W Snow White



A Satin Silver
A Satin Silver



B Jet Black
B Jet Black



H Anodic Champagne
H Anodic Champagne



G Satin Gold
G Satin Gold



K Satin Copper
K Satin Copper

Ringo Star Recessed



JJA Head Office, Gonesse, France
Liquid Line F3
Photography: Guillaume Guerin



Münsterland Hall, Münster, Germany
Matric F1
Realization and photography:
Scharkon Lichtkonzepte GmbH/Oliver Kahl Photography



Ringo Star F1 | System 100mm Recessed Frame

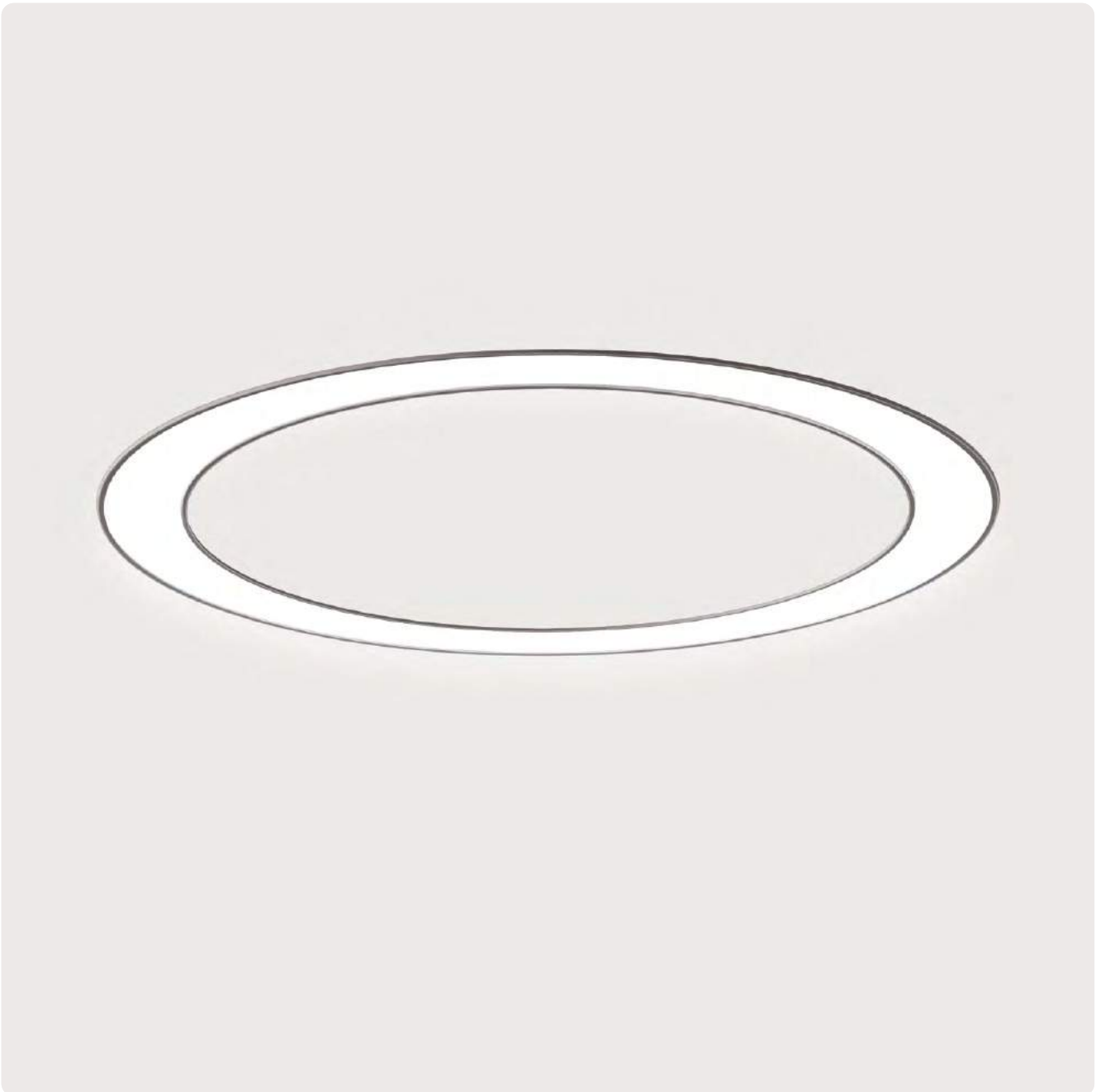

DE LED-Einbauleuchte für gesägte Deckenöffnungen. Rein direktstrahlend. Leuchtenkörper mit umlaufendem Rahmen aus Aluminiumprofil. Optikbreite 100mm. 13 verschiedene Durchmesser von 600mm bis 8000mm. Oberfläche weiß, silber, graphit, schwarz, champagner oder kupferfarben lackiert. Weitere Oberflächenoptionen siehe Lightnet-Surface-Collection oder RAL nach Wahl. Microprismenoptik mit optimierter Blendungsbegrenzung speziell für Office-Anwendungen. Satinierter Opaldiffusor für Allgemeinbeleuchtung mit max. Transmissionsgrad und homogener Lichtpunktauflösung. Konverter in Leuchtgehäuse integriert, wahlweise einfach schaltbar oder stufenlos dimmbar (DALI, Touch-Dim, Casambi). Farbtemperatur 2200K, 2700K, 3000K, 3500K, 4000K, 6500K oder Tunable White (2700-6500K). Binning initial \leq MacAdam 3. Farbwiedergabe CRI>80, CRI>90 oder Full Spectrum. Höhenverstellbares Set von Pendelabhängungen zur Montage an Rohbetondecke inklusive.

EN Recessed mounted LED luminaire for ceilings with cut-out openings. Direct only light distribution. Luminaire body with surrounding frame made of aluminium profile. Optic width 100mm. 13 different diameters from 600mm to 8000mm. Surface white, silver, graphite, black, champagne or copper coated. Further surface options see Lightnet-Surface-Collection or RAL of your choice. Microprismatic screen with optimized glare reduction especially for workplaces. Satin opal diffuser for general lighting with maximum transmittance and homogeneous lighting. Driver integrated into luminaire housing, optionally switchable or dimmable (DALI, Touch-Dim, Casambi). Colour temperature 2200K, 2700K, 3000K, 3500K, 4000K, 6500K or Tunable White (2700-6500K). Binning \leq MacAdam 3. Colour rendering CRI>80, CRI>90 or Full Spectrum. Height-adjustable set of pendant suspensions for mounting on raw concrete ceiling included.

R F1 O W E-8 30 M-D1500

- Product Family **R:** Ringo Star
- Type **F1:** Direct only
- Optical System **A:** Microprismatic, **O:** Opal Diffuser
- Surface Finish **W:** Snow White, **V:** Ivory White, **S:** Radiant Silver, **U:** Urban Graphite, **B:** Jet Black, **H:** Anodic Champagne, **K:** Satin Copper
- Control Gear **E:** On/Off, **L:** DALI, **H:** Touch-Dim, **C:** Casambi, **6:** DALI DT6 for TW, **8:** DALI DT8 for TW [D900-D8000]
- Colour Rendering **8:** CRI>80, **9:** CRI>90, **F:** Full Spectrum [except 2200K]
- Colour Temperature **22:** 2200K, **27:** 2700K, **30:** 3000K, **35:** 3500K, **40:** 4000K, **65:** 6500K, **TW:** Tunable White 2700-6500K
- Power **E:** Low Power, **M:** Medium Power
- Size Luminaire Diameter in mm: **D600, D900, D1200, D1500, D2000, D2500, D3000, D3500, D4000, D5000, D6000, D7000, D8000**
- On Request Emergency Module [D900-D8000]



Microprismatic | Direct

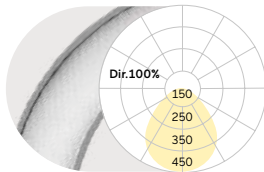

Opal Diffuser | Direct

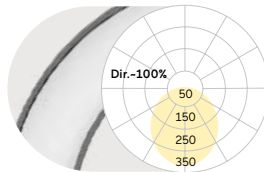

D mm	Lumen/Watt		D mm	Lumen/Watt	
	Low Power	Medium Power		Low Power	Medium Power
600	3810lm/34W	4790lm/45W	600	4090lm/34W	5150lm/45W
900	6460lm/59W	7900lm/75W	900	6930lm/59W	8490lm/75W
1200	8750lm/79W	10260lm/95W	1200	9400lm/79W	11030lm/95W
1500	10980lm/98W	13200lm/120W	1500	11800lm/98W	14180lm/120W
2000	14650lm/131W	18330lm/168W	2000	15730lm/131W	19690lm/168W
2500	18900lm/166W	23090lm/207W	2500	20300lm/166W	24800lm/207W
3000	23260lm/202W	28420lm/252W	3000	24990lm/202W	30520lm/252W
3500	26170lm/227W	31970lm/281W	3500	28110lm/227W	34340lm/281W
4000	30530lm/271W	37290lm/338W	4000	32790lm/271W	40060lm/338W
5000	37800lm/332W	46170lm/414W	5000	40600lm/332W	49600lm/414W
6000	46520lm/405W	56830lm/504W	6000	49970lm/405W	61050lm/504W
7000	55240lm/496W	67490lm/617W	7000	59340lm/496W	72500lm/617W
8000	61780lm/536W	75480lm/667W	8000	66370lm/536W	81080lm/667W

Lumen Values: Luminaire luminous flux at 4000K/CRI>80. Other configurations on request.

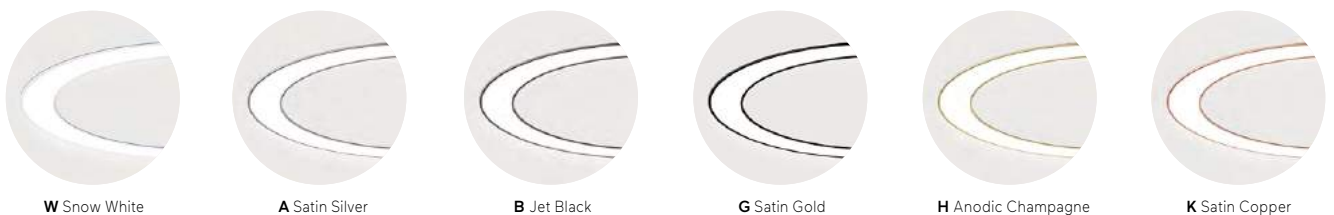
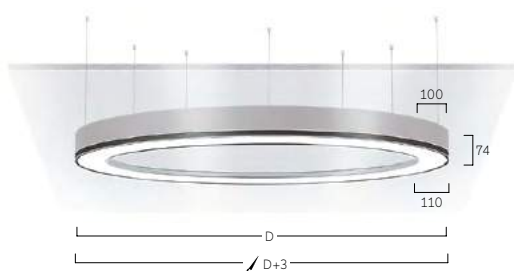

Liquid Line Compact F5 | Recessed Frame



DE LED-Einbauleuchte für gesägte Deckenöffnungen. Rein direktstrahlend. Leuchtenkörper mit feinen Radien aus Aluminium, umlaufender Rahmen gefertigt aus einem Guss ohne sichtbare Nahtstellen. Oberfläche in weiß, silber, graphit, schwarz oder champagnerfarben lackiert. Weitere Oberflächenoptionen siehe Lightnet Surface Collection oder RAL nach Wahl. Präzisionslinsen mit Abblendraster für breite rotationssymmetrische Lichtstärkeverteilung bei gleichzeitig hoher Blendungsbegrenzung (UGR<19). Abblendraster in verschiedenen Oberflächen verfügbar. Separater Konverter im Lieferumfang enthalten, wahlweise einfach schaltbar oder stufenlos dimmbar (DALI). Farbtemperatur 2200K, 2700K, 3000K, 3500K, 4000K oder 6500K. Binning initial \leq MacAdam 3. Farbwiedergabe CRI>80, CRI>90 oder Full Spectrum.

EN Recessed mounted LED luminaire for ceilings with cut-out openings. Direct only light distribution. Luminaire body with smooth bends made of aluminium, complete frame crafted in one piece with no visible seams. Surface white, silver, graphite, black or champagne coated. Further surface options see Lightnet-Surface-Collection or RAL of your choice. Precision lenses with louvre for wide uniform symmetrical light distribution with high glare limitation (UGR<19). Louvre available in various surfaces. Separate driver included, optionally switchable or dimmable (DALI). Colour temperature 2200K, 2700K, 3000K, 3500K, 4000K or 6500K. Binning \leq MacAdam 3. Colour rendering CRI>80, CRI>90 or Full Spectrum.

Q F5 LWE-8 30H-L149-B

Product Family	Q: Liquid Line
Type	F5: Direct only
Optical System	L: Lens Louvre
Surface Finish	W: Snow White, V: Ivory White, A: Satin Silver, U: Urban Graphite, B: Jet Black, H: Anodic Champagne, K: Satin Copper
Control Gear	E: On/Off, L: DALI, H: Touch-Dim
Colour Rendering	8: CRI>80, 9: CRI>90, F: Full Spectrum [except 2200K]
Colour Temperature	22: 2200K, 27: 2700K, 30: 3000K, 35: 3500K, 40: 4000K 65: 6500K
Power	M: Medium Power, H: High Power
Size	Luminaire Length in mm: L149, L281, L413
Lens Louvre	W: Snow White, A: Satin Silver, B: Jet Black, H: Anodic Champagne, K: Satin Copper, G: Satin Gold



Lens Louvre | Direct

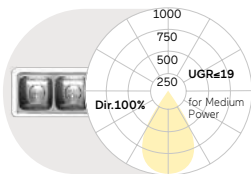

L mm	Lumen/Watt Medium Power	Lumen/Watt High Power
149	620lm/7W	820lm/9W
281	1240lm/12W	1640lm/17W
413	1860lm/16W	2460lm/23W

Lumen Values: Luminaire luminous flux at 4000K/CRI>80. Other configurations on request.

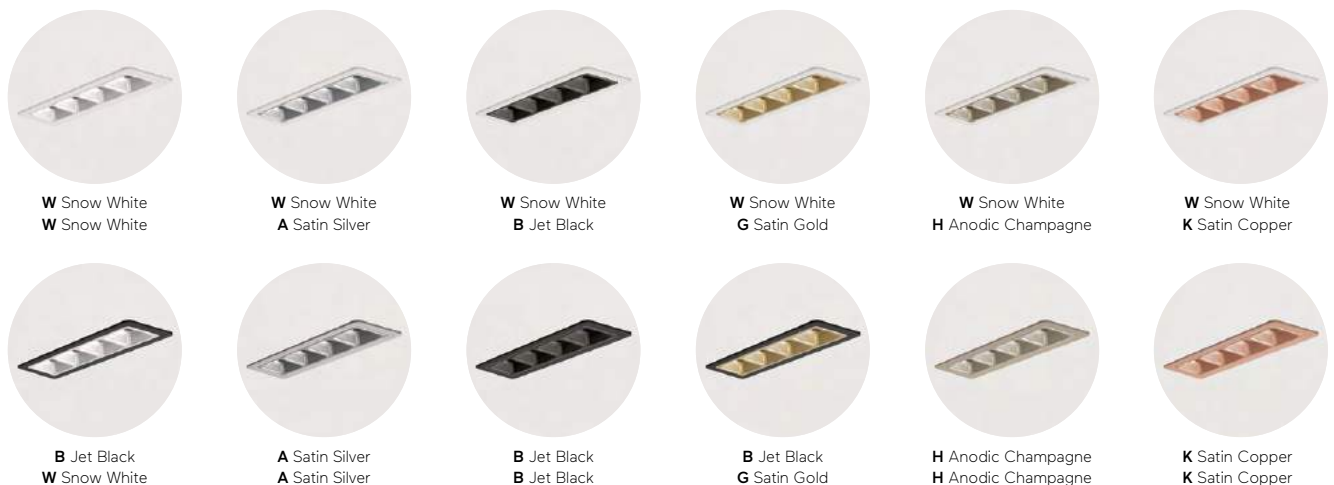
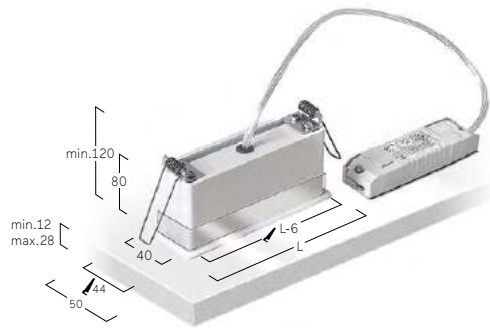

Liquid Line QX/FX | System 40mm Recessed



DE LED-System-Einbauleuchte. Version FX mit umlaufendem Rand für gesägte Deckenöffnungen. Version QX nur einseitig mit Rand speziell für wandbündige Deckeneinbaumontage. Rein direktstrahlend. Hochflexibles System bestehend aus linearen Elementen, gebogenen Elementen sowie Y- und X-Verbindungselementen. Jedes Modul ist dabei als unabhängige Einzeleuchte mit integriertem Konverter konzipiert und kann mit den anderen Modulen durch ein durchdachtes Konnektor-System zu beliebigen Lichtstrukturen verbunden werden. Millimetergenaue Längenfertigung sowie Sonderradien (nur Opal) möglich. Auf Grundlage skizzierter Kundenvorgabe erstellt Lightnet technische Zeichnung der gewünschten Struktur zur Prüfung und Freigabe. Leuchtenkörper mit feinen Radien aus Aluminiumprofil mit 40mm Optikbreite, gefertigt aus einem Guss ohne sichtbare Nahtstellen

an den Stirnseiten. Oberfläche weiß, silber, graphit, schwarz, champagner oder kupferfarben lackiert. Weitere Oberflächenoptionen siehe Lightnet-Surface-Collection oder RAL nach Wahl. Präzisionslinsen mit Abblenderaster für breite rotationssymmetrische Lichtstärkeverteilung bei gleichzeitig hoher Blendungsbegrenzung ($UGR < 19$). Abblenderaster in verschiedenen Oberflächen verfügbar. Satinierter Opaldiffusor für Allgemeinbeleuchtung mit max. Transmissionsgrad und homogener Lichtpunktauflösung. Konverter wahlweise einfach schaltbar oder stufenlos dimmbar (DALI, Touch-Dim, Casambi). Farbtemperatur 2200K, 2700K, 3000K, 3500K, 4000K oder 6500K. Binning initial \leq MacAdam 3. Farbwiedergabe $CRI > 80$, $CRI > 90$ oder Full Spectrum. Höhenverstellbares Set von Pendelabhängungen zur Montage an Rohbetondecke inklusive.

Linear Modules

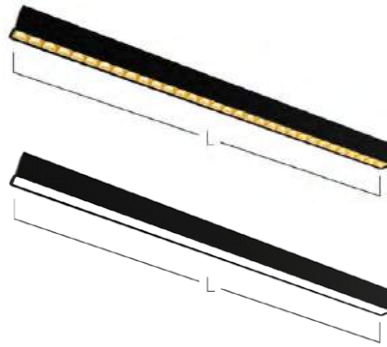

Lens Louvre

L[mm]	668	932	1197	1461	1726	1990
-------	-----	-----	------	------	------	------

Opal Flex Diffuser

L[mm]	600	890	1182	1475	1765	2055
-------	-----	-----	------	------	------	------

Curve Modules

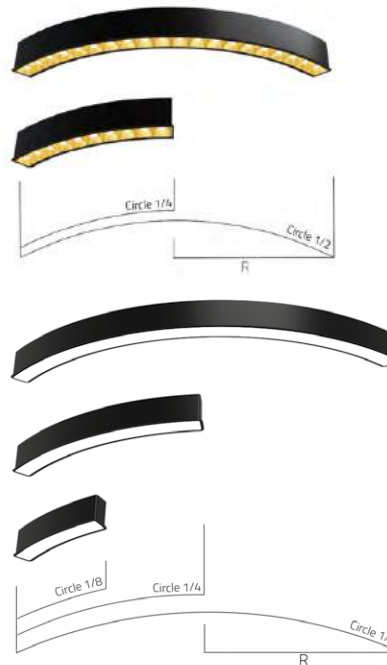

1/2 Curve, Lens Louvre

R[mm]	300	450	622,5
L[mm]	942	1414	1956

1/4 Curve, Lens Louvre

R[mm]	300	450	622,5
L[mm]	471	708	978

1/2 Curve, Opal Flex Diffuser

R[mm]	300	450	622,5	750
L[mm]	942	1414	1956	2356

1/4 Curve, Opal Flex Diffuser

R[mm]	300	622,5	750	1000
L[mm]	471	978	1178	1570

1/8 Curve, Opal Flex Diffuser

R[mm]	300	622,5	1000
L[mm]	236	489	785

EN LED recessed mounted light system. FX version with complete frame for ceilings. Version QX with frame on one side to allow mounting near walls. Direct only light distribution. Highly flexible system consisting of linear elements, curved elements and Y- and X-connectors. Each module is designed as a stand-alone luminaire with an integrated driver and can be connected to the other modules using a sophisticated connector system to create any desired lighting structure. Millimeter-precise length production as well as special bends (Opal only) possible. Based on customer specification, Lightnet creates technical drawings of the desired structure for review and approval with the drawings almost 100% true to the required design. Luminaire body with smooth bends made of aluminium profile

with 40mm optic width, crafted in one piece with no visible seams at the ends. Surface white, silver, graphite, black, champagne or copper coated. Further surface options see Lightnet-Surface-Collection or RAL of your choice. Precision lenses with louvre for wide uniform symmetrical light distribution with high glare limitation (UGR<19). Louvre available in various surfaces. Satin opal diffuser for general lighting with maximum transmittance and homogeneous lighting. Driver optionally switchable or dimmable (DALI, Touch-Dim, Casambi). Colour temperature 2200K, 2700K, 3000K, 3500K, 4000K or 6500K. Binning ≤ MacAdam 3. Colour rendering CRI>80, CRI>90 or Full Spectrum. Height-adjustable set of pendant suspensions for mounting on concrete ceiling included.

Bend Modules

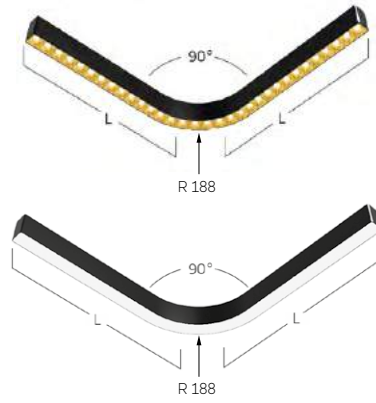

Lens Louvre

L[mm] 584 716 981

Opal Flex Diffuser

L[mm] 580 675 960

X-Junction Modules

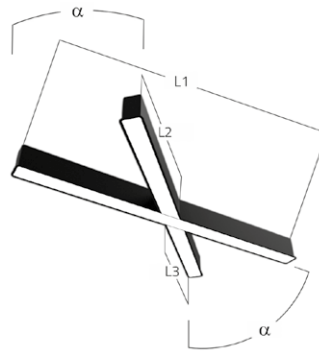
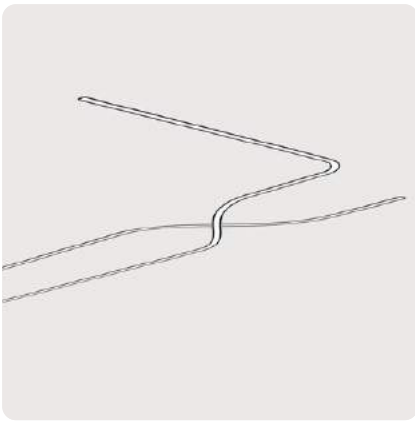

Y-Junction Modules

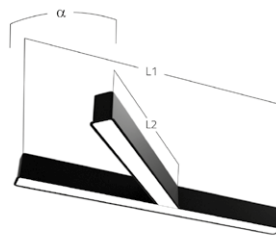

Version QX:

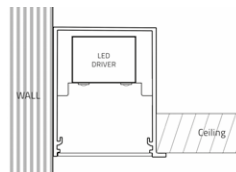

Version FX:

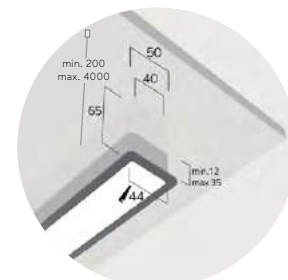
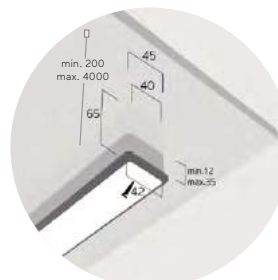
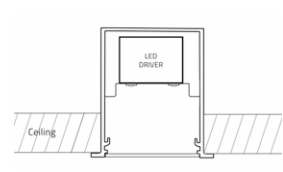



IP20 ~220-240V 50-60 Hz IK 02 RG0 ≤ 3 MAC/AMM L90B10 90000h L45B10 90000h L80B10 90000h CE UK CA

Lens Louvre | Direct

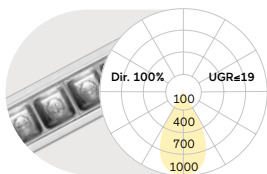

Lumen/Watt Low Power 1640lm/12,6W per m
Lumen/Watt High Power 3020lm/24,3W per m

Opal Flex Diffuser | Direct

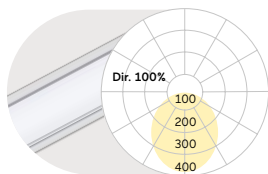

Lumen/Watt Medium Power 1550lm/15,6W per m
Lumen/Watt High Power 2150lm/21,8W per m

Lumen Values: Luminarie luminous flux at 4000K/CRI>80. Other configurations on request.



Midpin Spotlight XM
770lm/10W/Ø40mm



A Satin Silver
W Snow White



A Satin Silver
A Satin Silver



A Satin Silver
B Jet Black



A Satin Silver
G Satin Gold



A Satin Silver
H Anodic Champagne



A Satin Silver
K Satin Copper

Liquid Line Recessed





JJA Head Office, Gonesse, France
Liquid Line F3
Photography: Guillaume Guerin



Liquid Line Recessed

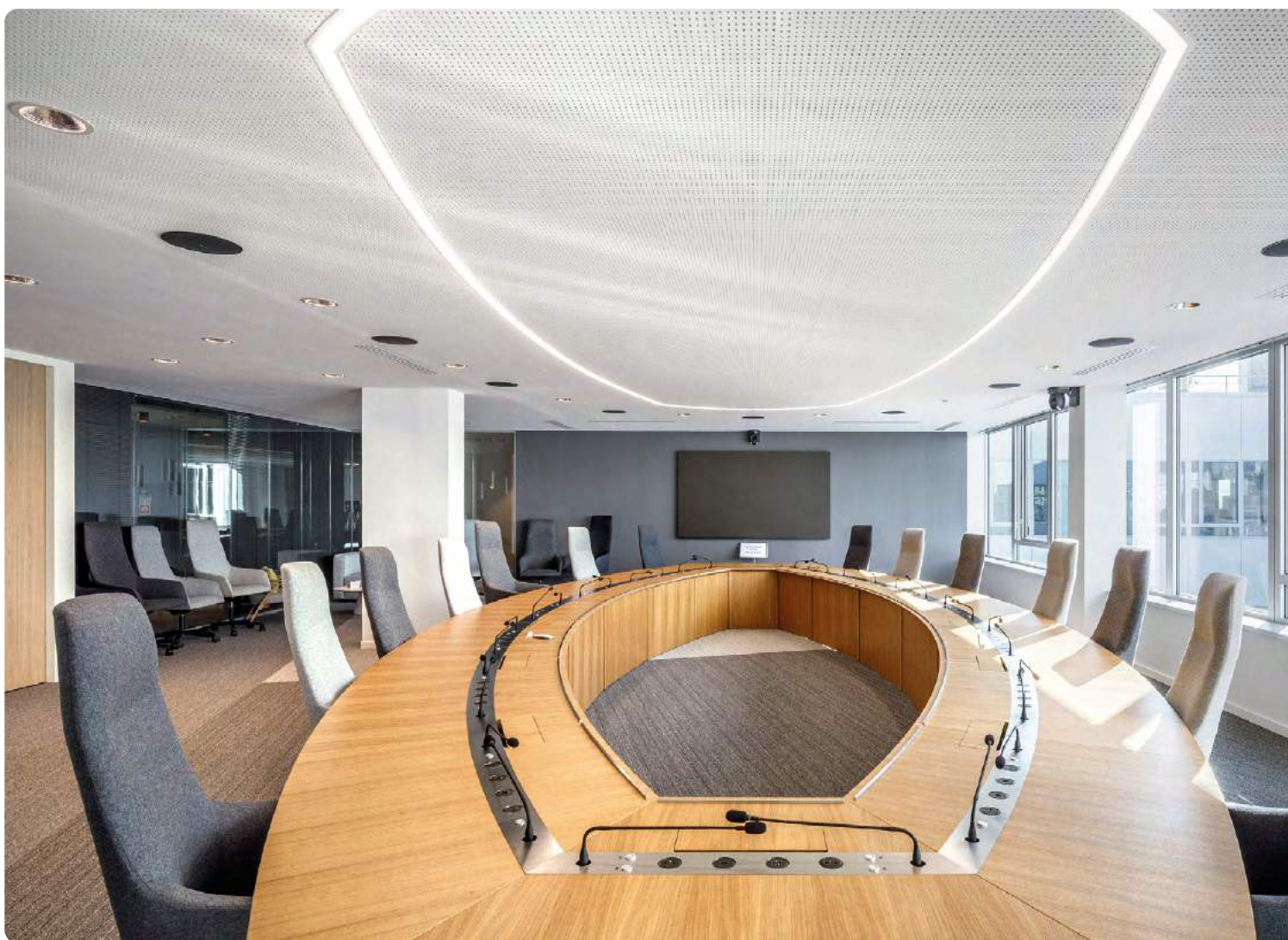

Crédit Agricole, St. Etienne, France
Liquid Line F3
Photography: ©11h45



Our Lady of Mercy College, Australia
Liquid Line F3
Realization and photography: LPA



Crédit Agricole, St. Etienne, France
Liquid Line F3
Photography: ©11h45



Liquid Line F3 | System 60mm Recessed



DE LED-System-Einbauleuchte für gesägte Deckenöffnungen. Rein direktstrahlend. Hochflexibles System bestehend aus linearen Elementen, gebogenen Elementen sowie Y- und X-Verbindungselementen. Jedes Modul ist dabei als unabhängige Einzeleuchte mit integriertem Konverter konzipiert und kann mit den anderen Modulen durch ein durchdachtes Konnektor-System zu beliebigen Lichtstrukturen verbunden werden. Millimetergenaue Längenfertigung sowie Sonderradien durch intelligentes softwarebasiertes Produktionssystem in Stückzahl 1 möglich. Auf Grundlage skizzierter Kundenvorgabe erstellt Lightnet technische Zeichnung der gewünschten Struktur zur Prüfung und Freigabe. Maximale Flexibilität ermöglicht nahezu 100%ige Umsetzung von kundenseitiger Entwurfsskizze in Produktions-

zeichnung. Leuchtenkörper mit feinen Radien aus Aluminiumprofil mit 60mm Optikbreite, gefertigt aus einem Guss ohne sichtbare Nahtstellen an den Stirnseiten. Oberfläche weiß, silber, graphit, schwarz, champagner oder kupferfarben lackiert. Weitere Oberflächenoptionen siehe Lightnet-Surface-Collection oder RAL nach Wahl. Microprismenoptik mit optimierter Blendungsbegrenzung speziell für Office-Anwendungen. Satinierter Opaldiffusor für Allgemeinbeleuchtung. Konverter wahlweise einfach schaltbar oder stufenlos dimmbar (DALI, Touch-Dim, Casambi). Farbtemperatur 2200K, 2700K, 3000K, 3500K, 4000K oder 6500K. Binning initial \leq MacAdam 3. Farbwiedergabe CRI>80, CRI>90 oder Full Spectrum.

Linear Modules



Linear Line

L[mm]	600	888	1178	1472	2340
-------	-----	-----	------	------	------

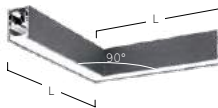

Sharp Corner

L[mm]	500
-------	-----

Curve Modules

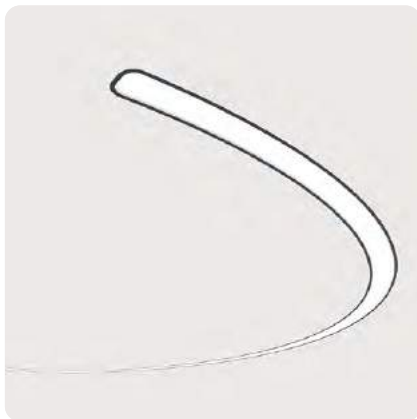

CH 1/2 Curve

R[mm]	500	750	1000
L[mm]	1570	2355	3140



CQ 1/4 Curve

R[mm]	500	750	1000	1250	1500	1750	2000
L[mm]	785	1178	1571	1964	2356	2749	3142



CE 1/8 Curve

R[mm]	1000	1500	2000	2500	3000	3500	4000
L[mm]	785	1178	1571	1964	2356	2749	3142

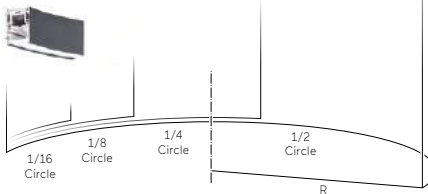

CS 1/16 Curve

R[mm]	2000	3000	3500
L[mm]	785	1178	1374

EN LED recessed light system for installation in ceiling cut-outs openings. Direct only light distribution. Highly flexible system consisting of linear elements, curved elements and Y- and X-connectors. Each module is designed as a stand-alone luminaire with an integrated driver and can be connected to the other modules using a sophisticated connector system to create any desired lighting structure. Millimeter-precise production as well as special curves (Opal only) possible. Based on customer specifications, Lightnet creates technical drawings of the desired structure for review and approval. Luminaire body

with smooth bends made of aluminium profile with 60mm optics width, crafted in one piece with no visible seams. Surface white, silver, graphite, black, champagne or copper coated. Further surface options see Lightnet-Surface-Collection or RAL of your choice. Microprismatic screen with optimized glare reduction especially for workplaces. Satin opal diffuser for general lighting. Driver optionally switchable or dimmable (DALI, Touch-Dim, Casambi). Colour temperature 2200K, 2700K, 3000K, 3500K, 4000K or 6500K. Binning ≤ MacAdam 3. Colour rendering CRI>80, CRI>90 or Full Spectrum.

X-Junction Modules

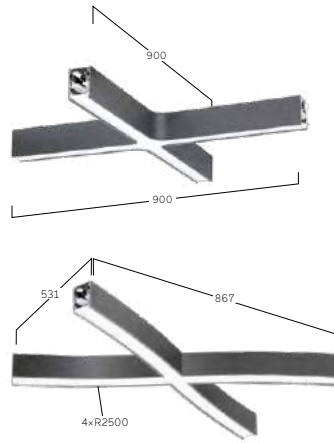

X1-Junction Module

L[mm] 1920

X2-Junction Module

L[mm] 1800

Y-Junction Modules

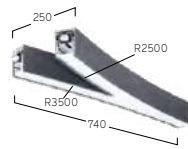
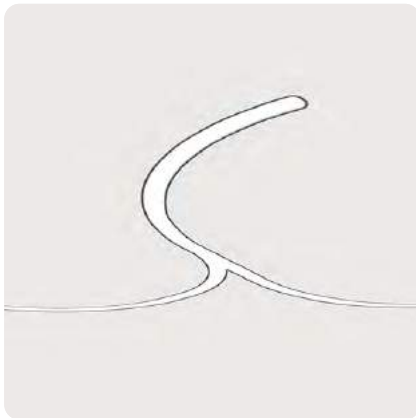

Y1-Junction

L[mm] 1450

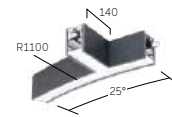

Y4-Junction

L[mm] 620

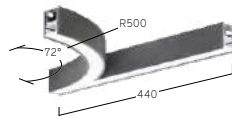

Y2-Junction

L[mm] 1069

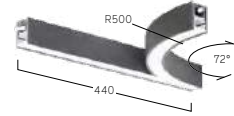

Y5-Junction

L[mm] 1069

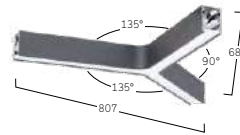

Y3-Junction

L[mm] 1875

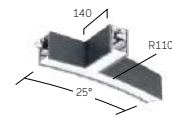

Y6-Junction

L[mm] 620

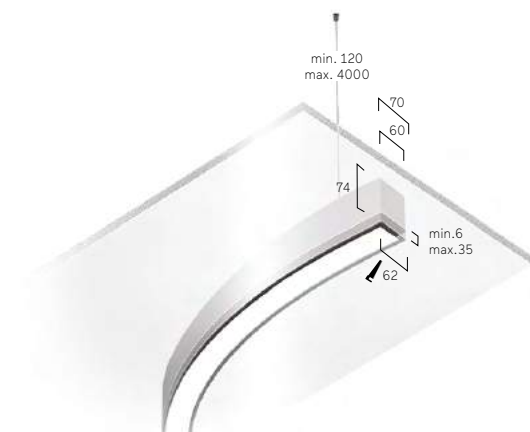

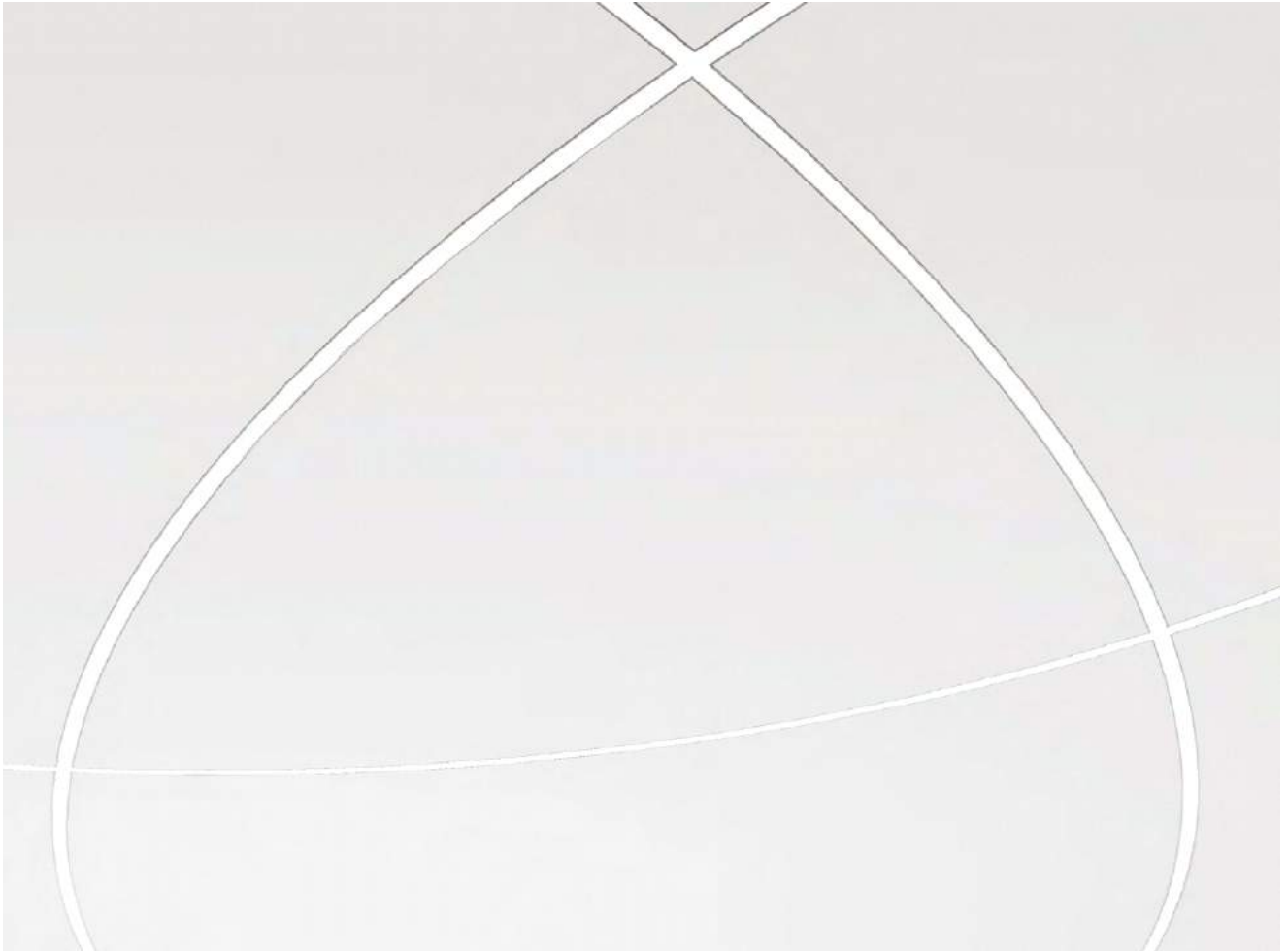

IP20 -220-240V 50-60 Hz IK 02 RG0 ≤ 3 MAC/NOHM LOW POWER L90B10 50000h MEDIUM POWER L85B10 50000h HIGH POWER L80B10 50000h CE UK CA

Microprismatic | Direct

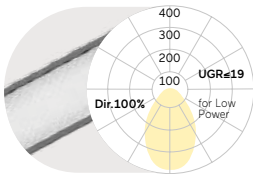

Lumen/Watt Low Power 1200lm/14,6W per m
Lumen/Watt Medium Power 1760lm/22,5W per m
Lumen/Watt High Power 2290lm/30,3W per m

Opal Diffuser | Direct

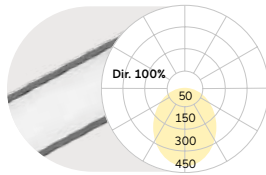

Lumen/Watt Low Power 1300lm/14,6W per m
Lumen/Watt Medium Power 1910lm/22,5W per m
Lumen/Watt High Power 2480lm/30,3W per m

Lumen Values: Luminaire luminous flux at 4000K/CRI>80. Other configurations on request.



W Snow White

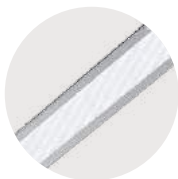

S Radiant Silver



U Urban Graphite



B Jet Black



H Anodic Champagne



K Satin Copper

Caleo Max M2 | Recessed Frameless



DE LED-Einbauleuchte für rahmenlose Montage in Gipskartondecken. Rein direktstrahlend. Leuchtenkörper aus Aluminium. Oberfläche weiß. Microprismenoptik mit optimierter Blendungsbegrenzung speziell für Office-Anwendungen. Satinierter Opaldiffusor für Allgemeinbeleuchtung. Konverter in Leuchtengehäuse integriert, wahlweise einfach schaltbar oder stufenlos dimmbar (DALI, Touch-Dim, Casambi). Farbtemperaturen 2200K, 2700K, 3000K, 3500K, 4000K, 6500K oder Tunable White. Binning initial \leq MacAdam 3. Farbwiedergabe CRI>80, CRI>90 oder Full Spectrum. Befestigungsset inklusive.

EN Recessed mounted LED luminaire for frameless installation in plasterboard ceilings. Direct only light distribution. Luminaire body made of aluminium. Surface white. Microprismatic screen with optimized glare reduction especially for workplaces. Satin opal diffuser for general lighting. Driver integrated into luminaire housing, optionally switchable or dimmable (DALI, Touch-Dim, Casambi). Colour temperature 2200K, 2700K, 3000K, 3500K, 4000K, 6500K or Tunable White. Binning \leq MacAdam 3. Colour rendering CRI>80, CRI>90 or Full Spectrum. Mounting brackets included.

AM2 AWE-8 30 M-Q340

Product Family	A: Caleo
Type	M2: Direct only
Optical System	A: Microprismatic, O: Opal Diffuser
Surface Finish	W: Snow White
Control Gear	E: On/Off, L: DALI, H: Touch-Dim, C: Casambi, 6: DALI DT6 for TW, 8: DALI DT8 for TW
Colour Rendering	8: CRI>80, 9: CRI>90, F: Full Spectrum [except 2200K]
Colour Temperature	22: 2200K, 27: 2700K, 30: 3000K, 35: 3500K, 40: 4000K, 65: 6500K, TW: Tunable White 2700-6500K
Power	M: Medium Power, H: High Power
Size	Square Size in mm: Q340, Q420, Q612
On Request	Radar Sensor, Emergency Module



Microprismatic | Direct

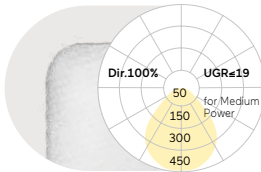

Opal Diffuser | Direct

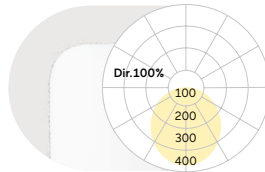

Q mm	Lumen/Watt Medium Power	Lumen/Watt High Power	Q mm	Lumen/Watt Medium Power	Lumen/Watt High Power
340	1230lm/12W	1810lm/18W	340	1390lm/12W	2050lm/18W
420	2010lm/19W	2920lm/27W	420	2280lm/19W	3310lm/27W
612	4580lm/40W	7250lm/65W	612	5180lm/40W	8220lm/65W

Lumen Values: Luminaire luminous flux at 4000K/CRI>80. Other configurations on request.

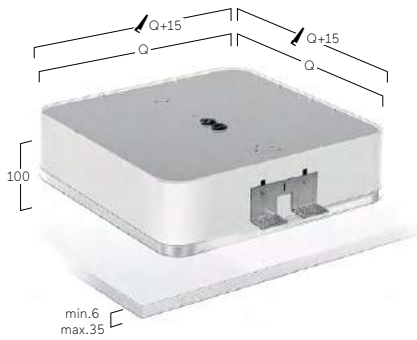

Cubic Max M2 | Recessed Frameless



DE LED-Einbauleuchte für rahmenlose Montage in Gipskartondecken. Rein direktstrahlend. Leuchtenkörper aus Aluminium. Oberfläche weiß pulverlackiert. Microprismenoptik mit optimierter Blendungsbegrenzung speziell für Office-Anwendungen. Satinierter Opaldiffusor für Allgemeinbeleuchtung mit max. Transmissionsgrad und homogener Lichtpunktauflösung. Konverter in Leuchtgehäuse integriert, wahlweise einfach schaltbar oder stufenlos dimmbar (DALI, Touch-Dim, Casambi). Farbtemperaturen 2700K, 3000K, 3500K, 4000K, 6500K oder Tunable White. Binning initial \leq MacAdam 3. Farbwiedergabe CRI $>$ 80, CRI $>$ 90 oder Full Spectrum. Befestigungsset zur Montage inklusive. Auf Anfrage: Integration von Notlichtkomponenten.

EN Recessed mounted LED luminaire for frameless installation in plasterboard ceilings. Direct only light distribution. Luminaire body made of aluminium. Surface white powder coated. Microprismatic screen with optimized glare reduction especially for workplaces. Satin opal diffuser for general lighting with maximum transmittance and homogeneous lighting. Driver integrated into luminaire housing, optionally switchable or dimmable (DALI, Touch-Dim, Casambi). Colour temperature 2700K, 3000K, 3500K, 4000K, 6500K or Tunable White. Binning \leq MacAdam 3. Colour rendering CRI $>$ 80, CRI $>$ 90 or Full Spectrum. Mounting brackets for assembly included. On request: Integration of emergency lighting components.

C M2 A WE-8 30 M-Q340

- Product Family **C:** Cubic
- Type **M2:** Direct only
- Optical System **A:** Microprismatic, **O:** Opal Diffuser
- Surface Finish **W:** Snow White
- Control Gear **E:** On/Off, **L:** DALI, **H:** Touch-Dim, **C:** Casambi, **6:** DALI DT6 for TW, **8:** DALI DT8 for TW
- Colour Rendering **8:** CRI>80, **9:** CRI>90, **F:** Full Spectrum [except 2200K]
- Colour Temperature **22:** 2200K, **27:** 2700K, **30:** 3000K, **35:** 3500K, **40:** 4000K, **65:** 6500K, **TW:** Tunable White 2700-6500K
- Power **M:** Medium Power, **H:** High Power
- Size Square Size in mm: **Q340, Q420, Q612**
- On Request Emergency Module



Microprismatic | Direct

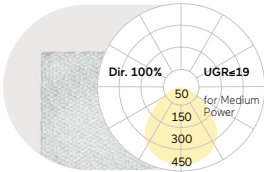

Opal Diffuser | Direct



Q mm	Lumen/Watt Medium Power	Lumen/Watt High Power	Q mm	Lumen/Watt Medium Power	Lumen/Watt High Power
340	1340lm/12W	1980lm/18W	340	1420lm/12W	2090lm/18W
420	2200lm/19W	3200lm/27W	420	2320lm/19W	3370lm/27W
612	5010lm/40W	7940lm/65W	612	5280lm/40W	8360lm/65W

Lumen Values: Luminaire luminous flux at 4000K/CRI>80. Other configurations on request.

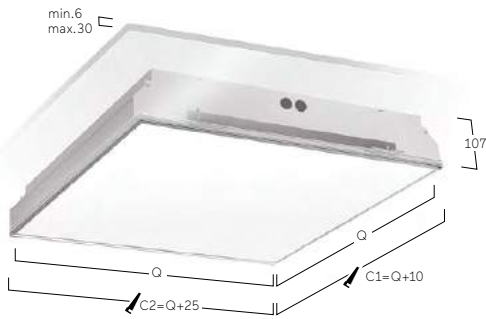

Cubic Max M4 | Recessed Frame



DE LED-Einbauleuchte für gesägte Deckenöffnungen. Rein direktstrahlend. Leuchtenkörper mit umlaufendem Rahmen aus Aluminium. Oberfläche natureloxiert oder weiß, graphit, schwarz, champagner oder kupferfarben lackiert. Weitere Oberflächenoptionen siehe Lightnet-Surface-Collection oder RAL nach Wahl. Microprismenoptik mit optimierter Blendungsbegrenzung speziell für Office-Anwendungen. Satinierter Opaldiffusor für Allgemeinbeleuchtung mit max. Transmissionsgrad und homogener Lichtpunktauflösung. Konverter in Leuchtgehäuse integriert, wahlweise einfach schaltbar oder stufenlos dimmbar (DALI, Touch-Dim). Farbtemperaturen 2200K, 2700K, 3000K, 3500K, 4000K, 6500K oder Tunable White. Binning initial \leq MacAdam 3. Farbwiedergabe CRI $>$ 80, CRI $>$ 90 oder Full Spectrum. Befestigungsset zur Montage inklusive. Nicht geeignet für Wandinstallation. Auf Anfrage: Integration von Notlichtkomponenten, Sensortechnologie.

EN Recessed mounted LED luminaire for cut-out ceilings. Direct only light distribution. Luminaire body with surrounding frame made of aluminium. Surface natural anodised or white, graphite, black, champagne or copper coated. Further surface options see Lightnet-Surface-Collection or RAL of your choice. Microprismatic screen with optimized glare reduction especially for workplaces. Satin opal diffuser for general lighting with maximum transmittance and homogeneous lighting. Driver integrated into luminaire housing, optionally switchable or dimmable (DALI, Touch-Dim). Colour temperature 2200K, 2700K, 3000K, 3500K, 4000K, 6500K or Tunable White. Binning \leq MacAdam 3. Colour rendering CRI $>$ 80, CRI $>$ 90 or Full Spectrum. Mounting brackets for assembly included. Vertical Installation not possible. On request: Integration of emergency lighting components, sensor technology.

C M4 A B E-8 30 M-Q379

- Product Family **C:** Cubic
- Type **M4:** Direct only
- Optical System **A:** Microprismatic, **O:** Opal Diffuser
- Surface Finish **W:** Snow White, **E:** Silver Anodised, **U:** Urban Graphite, **B:** Jet Black, **H:** Anodic Champagne
- Control Gear **E:** On/Off, **L:** DALI, **H:** Touch-Dim, **C:** Casambi, **6:** DALI DT6 for TW, **8:** DALI DT8 for TW
- Colour Rendering **8:** CRI>80, **9:** CRI>90, **F:** Full Spectrum [except 2200K]
- Colour Temperature **22:** 2200K, **27:** 2700K, **30:** 3000K, **35:** 3500K, **40:** 4000K, **65:** 6500K, **TW:** Tunable White 2700-6500K
- Power **M:** Medium Power, **H:** High Power
- Size Square Size in mm: **Q379, Q479, Q621, Q910**
- On Request Emergency Module



Microprismatic | Direct

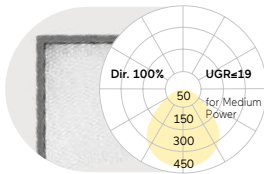

Opal Diffuser | Direct

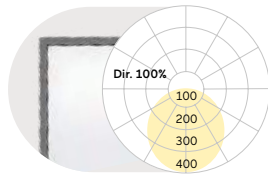

Q mm	Lumen/Watt Medium Power	Lumen/Watt High Power	Q mm	Lumen/Watt Medium Power	Lumen/Watt High Power
379	1310lm/12W	1940lm/18W	379	1350lm/12W	1990lm/18W
479	2150lm/19W	3130lm/27W	479	2210lm/19W	3210lm/27W
621	4720lm/38W	6930lm/58W	621	4850lm/38W	7120lm/58W
910	7770lm/67W	12840lm/129W	910	7980lm/67W	13190lm/129W

Lumen Values: Luminaire luminous flux at 4000K/CRI>80. Other configurations on request.

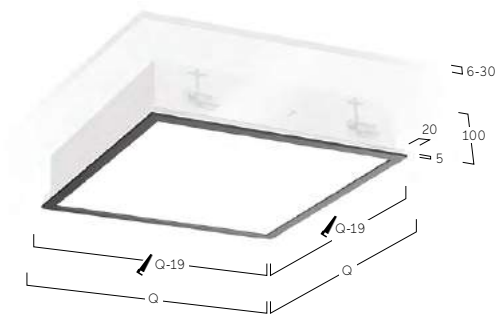

W Snow White



E Silver Anodised



U Urban Graphite



B Jet Black



H Anodic Champagne

Cubic M7 | Ambient Recessed Frame



DE LED- Einbauleuchte für gesägte Deckenöffnungen. Direkt-rundumstrahlend für dezente Deckenaufhellung. Leuchtenkörper mit umlaufendem Rahmen aus Aluminium. Oberfläche natureloxiert oder weiß, graphit, schwarz bzw. champagnerfarben lackiert. Weitere Oberflächenoptionen siehe Lightnet-Surface-Collection oder RAL nach Wahl. Ambientdiffusor aus satiniertem Acrylglas für Allgemeinbeleuchtung. Konverter in Leuchtgehäuse integriert, wahlweise einfach schaltbar oder stufenlos dimmbar (DALI, Touch-Dim, Casambi). Farbtemperaturen 2700K, 3000K, 3500K, 4000K, 6500K oder Tunable White. Binning initial \leq MacAdam 3. Farbwiedergabe CRI $>$ 80, CRI $>$ 90 oder Full Spectrum. Befestigungsset zur Montage inklusive. Auf Anfrage: Integration von Notlichtkomponenten, Sensortechnologie.

EN Recessed mounted LED luminaire for ceilings with cut-out openings. Omnidirectional light distribution for discreet illumination of the ceiling. Luminaire body with surrounding frame made of aluminium. Surface natural anodised or white, graphite, black or champagne coated. Further surface options see Lightnet-Surface-Collection or RAL of your choice. Ambient diffuser made of frosted acrylic glass for general lighting. Driver integrated into luminaire housing, optionally switchable or dimmable (DALI, Touch-Dim, Casambi). Colour temperature 2700K, 3000K, 3500K, 4000K, 6500K or Tunable White. Binning \leq MacAdam 3. Colour rendering CRI $>$ 80, CRI $>$ 90 or Full Spectrum. Mounting brackets for assembly included. On request: Integration of emergency lighting components, sensor technology.

C M7 F B E-8 30 M-Q379

- Product Family **C:** Cubic
- Type **M7:** Direct only
- Optical System **F:** Ambient
- Surface Finish **W:** Snow White, **E:** Silver Anodised, **U:** Urban Graphite, **B:** Jet Black, **H:** Anodic Champagne
- Control Gear **E:** On/Off, **L:** DALI, **H:** Touch-Dim, **C:** Casambi, **6:** DALI DT6 for TW, **8:** DALI DT8 for TW
- Colour Rendering **8:** CRI>80, **9:** CRI>90, **F:** Full Spectrum [except 2200K]
- Colour Temperature **22:** 2200K, **27:** 2700K, **30:** 3000K, **35:** 3500K, **40:** 4000K, **65:** 6500K, **TW:** Tunable White 2700-6500K
- Power **M:** Medium Power, **H:** High Power
- Shize Square Size in mm: **Q379, Q479, Q621**
- On Request Emergency Module



Ambient Diffuser | Direct

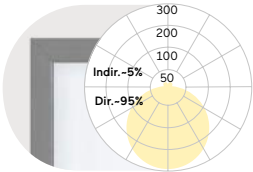

Q mm	Lumen/Watt Medium Power	Lumen/Watt High Power
379	1310lm/12W	1930lm/18W
479	2140lm/19W	3110lm/27W
621	4870lm/40W	7720lm/65W

Lumen Values: Luminaire luminous flux at 4000K/CRI>80. Other configurations on request.

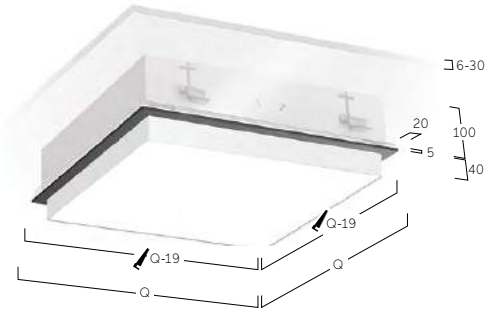

W Snow White



E Silver Anodised



U Urban Graphite



B Jet Black



H Anodic Champagne

Cubic Déco L3 | Recessed Frame



DE LED-Einbauleuchte für gesägte Deckenöffnungen. Rein direktstrahlend. Leuchtenkörper mit umlaufendem Rahmen aus Aluminiumprofil. Außenrahmen und dekorativer Reflektoring in unterschiedlichen Lackierungen und Kombinationen erhältlich, z.B. weiß, silber, graphit, schwarz, gold oder kupferfarben. Zu Oberflächenoptionen- und Kombinationen siehe Lightnet-Surface-Collection oder Bi-Colour-Auswahl. Rückversetzte Microprismenoptik mit optimierter Blendungsbegrenzung speziell für Office-Anwendungen. Satiniertes Opaldiffusor für Allgemeinbeleuchtung mit max. Transmissionsgrad und homogener Lichtpunktauflösung. Konverter in Leuchtengehäuse integriert, wahlweise einfach schaltbar oder stufenlos dimmbar (DALI, Touch-Dim, Casambi). Farbtemperatur 2200K, 2700K, 3000K, 3500K, 4000K, 6500K oder Tunable White (2700-6500K). Binning initial \leq MacAdam 3. Farbwiedergabe CRI $>$ 80, CRI $>$ 90 oder Full Spectrum. Befestigungsset zur Montage inklusive. Nicht geeignet für Wandinstallation. Auf Anfrage: Integration von Notlichtkomponenten, Sensortechnologie.

EN Recessed mounted LED luminaire for ceilings with cut-out openings. Direct only light distribution. Luminaire body with surrounding frame made of aluminium profile. Outer frame and decorative trim available in various finishes and combinations, e.g. white, silver, graphite, black, gold or copper coated. For surface options and combinations check Lightnet Surface Collection or Bi-Colour Selection. Recessed microprismatic screen with optimized glare reduction especially for workplaces. Satin opal diffuser for general lighting with maximum transmittance and homogeneous lighting. Driver integrated into luminaire housing, optionally switchable or dimmable (DALI, Touch-Dim, Casambi). Colour temperature 2200K, 2700K, 3000K, 3500K, 4000K, 6500K or Tunable White (2700-6500K). Binning \leq MacAdam 3. Colour rendering CRI $>$ 80, CRI $>$ 90 or Full Spectrum. Mounting brackets for assembly included. Vertical Installation not possible. On request: Integration of emergency lighting components, sensor technology.

C L3 A B E-8 30 M-Q350-G

Product Family	C: Cubic
Type	L3: Direct only
Optical System	A: Microprismatic, O: Opal Diffuser
Surface Finish	W: Snow White, S: Radiant Silver, U: Urban Graphite, B: Jet Black, H: Anodic Champagne
Control Gear	E: On/Off, L: DALI, H: Touch-Dim, C: Casambi, 6: DALI DT6 for TW, 8: DALI DT8 for TW
Colour Rendering	8: CRI>80, 9: CRI>90, F: Full Spectrum [except 2200K]
Colour Temperature	22: 2200K, 27: 2700K, 30: 3000K, 35: 3500K, 40: 4000K, 65: 6500K, TW: Tunable White 2700-6500K
Power	M: Medium Power, H: High Power
Size	Square Size in mm: Q350, Q450, Q550, Q650
Reflector	W: Snow White, V: Ivory White, S: Radiant Silver, U: Urban Graphite, B: Jet Black, H: Anodic Champagne, K: Satin Copper, G: Satin Gold
On Request	Emergency Module



Microprismatic | Direct

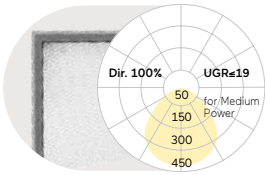

Opal Diffuser | Direct

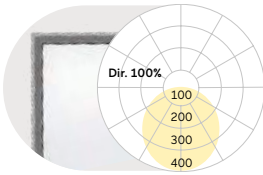

Q mm	Lumen/Watt		Q mm	Lumen/Watt	
	Medium Power	High Power		Medium Power	High Power
350	1360lm/12W	2010lm/18W	350	1400lm/12W	2070lm/18W
450	2370lm/19W	3450lm/27W	450	2440lm/19W	3550lm/27W
550	3630lm/27W	6790lm/50W	550	3740lm/27W	6990lm/50W
650	5200lm/40W	8500lm/65W	650	5360lm/40W	8760lm/65W

Lumen Values: Luminaire luminous flux at 4000K/CRI>80. Other configurations on request.

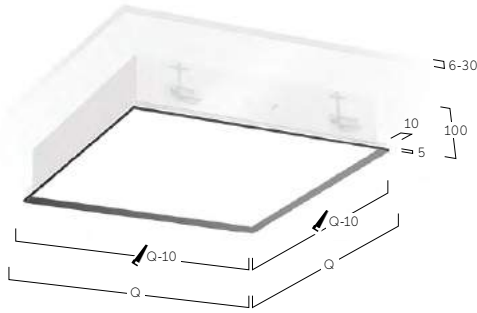

W Snow White
W Snow White



W Snow White
S Radiant Silver

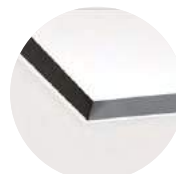

W Snow White
U Urban Graphite



W Snow White
B Jet Black



W Snow White
H Anodic Champagne

Matric Déco M9 | Recessed Frameless



DE LED-Einbauleuchte für rahmenlose Montage in Gipskartondecken. Rein direktstrahlend. Lichtkanal aus Aluminiumprofil. Millimetergenaue Längenfertigung nach Vorgabe möglich. Rückversetzte Optik für bessere Blendungsbegrenzung und dekorative Lichtwirkung. Rundum laufender Reflektorring in unterschiedlichen Lackierungen und Kombinationen erhältlich. Oberflächenoptionen siehe Lightnet-Surface-Collection oder RAL nach Wahl. Direktanteil über Präzisionslinsen mit Abblendraster für breite rotationssymmetrische Lichtstärkeverteilung bei gleichzeitig hoher Blendungsbegrenzung (UGR<19) für Office Anwendungen. Abblendraster in verschiedenen Farbkombinationen erhältlich. Microprismenoptik aus Spezialacrylglas mit optimierter Blendungsbegrenzung für Office-Anwendungen. Satiniertes Opaldiffusor für Allgemeinbeleuchtung mit max. Transmissionsgrad und homogener Lichtpunktauflösung. Konverter in Leuchtengehäuse integriert, wahlweise einfach schaltbar oder stufenlos dimmbar (DALI, Touch-Dim, Casambi). Farbtemperatur 2200K, 2700K, 3000K, 3500K, 4000K, 6500K oder Tunable White (2700-6500K). Binning initial \leq MacAdam 3. Farbwiedergabe CRI>80, CRI>90 oder Full Spectrum. Wahlweise Einbaurahmen für Installation mit Schattenfuge, alternativ Befestigungsset für Installation ohne Schattenfuge. Einbaurahmen oder Leuchtenprofil für Montage vorab lieferbar; restliche Leuchtenkomponenten zeitlich versetzt montierbar. Auf Anfrage: Integration von Notlichtkomponenten, Sensortechnologie.

EN Recessed mounted LED luminaire for frameless installation in plasterboard ceilings. Direct only light distribution. Light channel made of aluminium profile. Bespoke lengths possible. Recessed diffuser with optimized glare reduction and decorative lighting impact. All around decorative trim available in various finishes and combinations. Further surface options see Lightnet-Surface-Collection or RAL of your choice. Direct light using precision lenses with louvre for wide uniform symmetrical light distribution with high glare limitation (UGR<19) especially for workplaces. Louvre available in various colour finishes. Microprismatic screen made of special acrylic glass with optimized glare reduction especially for workplaces. Satin opal diffuser for general lighting with maximum transmittance and homogeneous lighting. Driver integrated into luminaire housing, optionally switchable or dimmable (DALI, Touch-Dim, Casambi). Colour temperature 2200K, 2700K, 3000K, 3500K, 4000K, 6500K or Tunable White (2700-6500K). Binning \leq MacAdam 3. Colour rendering CRI>80, CRI>90 or Full Spectrum. Optional mounting frame for installation with shadow gap, alternative mounting brackets for installation without shadow gap. Mounting frame or luminaire profile available in advance for mounting; other luminaire components can be mounted at different times. On request: Integration of emergency lighting components, sensor technology.

LM9LWE-830E-L1209-BB*

Product Family	L: Matric
Type	M9: Direct only
Optical System	A: Microprismatic, O: Opal Diffuser, L: Lens Louver*
Surface Finish	W: Snow White
Control Gear	E: On/Off, L: DALI, H: Touch-Dim, C: Casambi [L890-L2055], 6: DALI DT6 for TW [L1182-L2055], 8: DALI DT8 for TW [L890-L2055]
Colour Rendering	8: CRI>80, 9: CRI>90, F: Full Spectrum (except 2200K)
Colour Temperature	22: 2200K, 27: 2700K, 30: 3000K, 35: 3500K, 40: 4000K, 65: 6500K, TW: Tunable White 2700-6500K
Power	E: Low Power, M: Medium Power, H: High Power
Size	Luminaire Length in mm (Microprismatic, Opal Diffuser): L600, L890, L1182, L1475, L1765, L2055 Luminaire Length in mm (Lens Louver*): L681, L945, L1209, L1474, L1738, L2002
Installation	F: Installation Housing, B: Installation Brackets
Reflector colour	W: Snow White, V: Ivory White, A: Satin Silver, U: Urban Graphite, B: Jet Black, H: Anodic Champagne, K: Satin Copper, G: Satin Gold
On Request	Emergency Module [L1182-L2055]



Lens Louvre | Direct

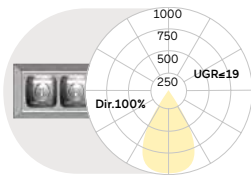

Microprismatic | Direct

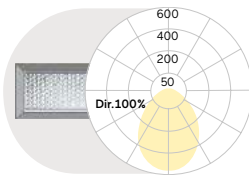

Opal Diffuser | Direct

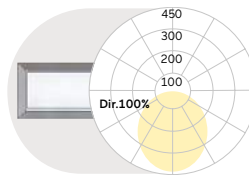

L mm	Lumen/Watt Low Power	Lumen/Watt High Power
681	1090lm/10W	2000lm/17W
945	1520lm/13W	2790lm/24W
1209	1960lm/16W	3590lm/30W
1474	2390lm/19W	4390lm/37W
1738	2830lm/23W	5190lm/43W
2002	3260lm/26W	5990lm/49W

L mm	Lumen/Watt Low Power	Lumen/Watt High Power
600	550lm/7W	990lm/12W
890	830lm/10W	1490lm/16W
1182	1110lm/12W	1990lm/21W
1475	1390lm/14W	2480lm/25W
1765	1660lm/17W	2980lm/30W
2055	1940lm/22W	3480lm/37W

L mm	Lumen/Watt Medium Power	Lumen/Watt High Power
600	780lm/9W	1060lm/12W
890	1170lm/12W	1590lm/16W
1182	1560lm/15W	2110lm/21W
1475	1950lm/19W	2640lm/25W
1765	2330lm/22W	3170lm/30W
2055	2720lm/28W	3700lm/37W

Lumen Values: Luminaire luminous flux at 4000K/CRI>80. Other configurations on request.

Installation Bracket without Shadow Gap



Installation Housing with Shadow Gap

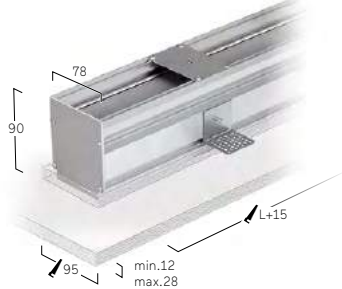

W Snow White



A Satin Silver

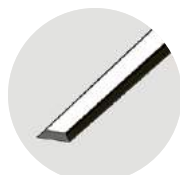

B Jet Black



G Satin Gold



H Anodic Champagne



K Satin Copper



W Snow White
W Snow White



W Snow White
A Satin Silver



W Snow White
H Anodic Champagne



W Snow White
B Jet Black

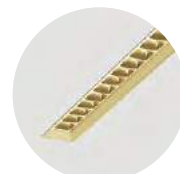

W Snow White
G Satin Gold

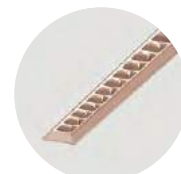

W Snow White
K Satin Copper

Matric Déco F9 | Recessed Frame



DE LED-Einbauleuchte für Montage in gesägten Deckenöffnungen. Rein direkt-strahlend. Lichtkanal mit umlaufendem Rahmen aus Aluminiumprofil. Millimetergenaue Längenfertigung nach Vorgabe möglich. Rückversetzte Optik für bessere Blendungsbegrenzung und dekorative Lichtwirkung. Außenrahmen und dekorativer Reflektorring in unterschiedlichen Lackierungen und Kombinationen erhältlich, z.B. weiß, silber, graphit, schwarz, gold oder kupferfarben. Zu Oberflächenoptionen- und Kombinationen siehe Lightnet-Surface-Collection oder Bi-Colour-Auswahl. Direktanteil über Präzisionslinsen mit Abblendraster für breite rotationssymmetrische Lichtstärkeverteilung bei gleichzeitig hoher Blendungsbegrenzung (UGR<19) für Office Anwendungen. Abblendraster in verschiedenen Farbkombinationen erhältlich. Microprismenoptik aus Spezialacrylglas mit optimierter Blendungsbegrenzung für Office-Anwendungen. Satiniertes Opaldiffusor für Allgemeinbeleuchtung. Konverter in Leuchtgehäuse integriert, wahlweise einfach schaltbar oder stufenlos dimmbar (DALI, Touch-Dim, Casambi). Farbtemperatur 2200K, 2700K, 3000K, 3500K, 4000K, 6500K oder Tunable White (2700-6500K). Binning initial \leq MacAdam 3. Farbwiedergabe CRI>80, CRI>90 oder Full Spectrum. Befestigungsset inklusive. Auf Anfrage: Integration von Notlichtkomponenten, Sensortechnologie.

EN Recessed mounted LED luminaire for installation in ceiling cut-outs openings. Direct only light distribution. Light channel with surrounding frame made of aluminium profile. Bespoke lengths possible. Recessed screen with optimized glare reduction and decorative lighting impact. Outer frame and decorative trim available in various finishes and combinations, e.g. white, silver, graphite, black, gold or copper coated. For further surface options see Lightnet-Surface-Collection or RAL of your choice. Direct light using precision lenses with louvre for wide uniform symmetrical light distribution with high glare limitation (UGR<19) especially for workplaces. Louvre available in various colour finishes. Microprismatic screen made of special acrylic glass with optimized glare reduction especially for workplaces. Satin opal diffuser for general lighting with maximum transmittance and homogeneous lighting. Driver integrated into luminaire housing, optionally switchable or dimmable (DALI, Touch-Dim, Casambi). Colour temperature 2200K, 2700K, 3000K, 3500K, 4000K, 6500K or Tunable White (2700-6500K). Binning \leq MacAdam 3. Colour rendering CRI>80, CRI>90 or Full Spectrum. Mounting brackets included. Luminaire profile available in advance for mounting; other luminaire components can be mounted at different times. On request: Integration of emergency lighting components, sensor technology.

LF9LWE-8 30E-L1224-B*

Product Family	L: Matric
Type	F9: Direct only
Optical System	A: Microprismatic, O: Opal Diffuser, L: Lens Louvre*
Surface Finish	W: Snow White, V: Ivory White, A: Satin Silver, E: Silver Anodised, U: Urban Graphite, B: Jet Black, H: Anodic Champagne, K: Satin Copper
Control Gear	E: On/Off, L: DALI, H: Touch-Dim, C: Casambi [L905-L2075], 6: DALI DT6 for TW [L1198-L2075], 8: DALI DT8 for TW [L905-L2075]
Colour Rendering	8: CRI>80, 9: CRI>90, F: Full Spectrum [except 2200K]
Colour Temperature	22: 2200K, 27: 2700K, 30: 3000K, 35: 3500K, 40: 4000K, 65: 6500K, TW: Tunable White 2700-6500K
Power	E: Low Power, M: Medium Power, H: High Power
Size	Luminaire Length in mm (Microprismatic, Opal Diffuser): L615, L905, L1198, L1490, L1780, L2075 Luminaire Length in mm (Lens Louvre*): L696, L960, L1224, L1489, L1753, L2017
Lens Louvre*	W: Snow White, V: Ivory White, S: Radiant Silver, U: Urban Graphite, B: Jet Black, H: Anodic Champagne, K: Satin Copper, G: Satin Gold
On Request	Emergency Module [L1198-L2075]



Lens Louvre | Direct

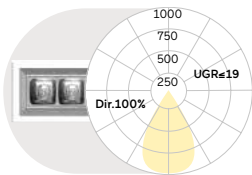

Microprismatic | Direct

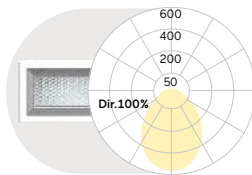

Opal Diffuser | Direct

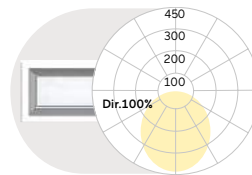

L mm	Lumen/Watt Low Power	Lumen/Watt High Power
681	1090lm/10W	2000lm/17W
945	1520lm/13W	2790lm/24W
1209	1960lm/16W	3590lm/30W
1474	2390lm/19W	4390lm/37W
1738	2830lm/23W	5190lm/43W
2002	3260lm/26W	5990lm/49W

L mm	Lumen/Watt Low Power	Lumen/Watt High Power
600	550lm/7W	990lm/12W
890	830lm/10W	1490lm/16W
1182	1110lm/12W	1990lm/21W
1475	1390lm/14W	2480lm/25W
1765	1660lm/17W	2980lm/30W
2055	1940lm/22W	3480lm/37W

L mm	Lumen/Watt Medium Power	Lumen/Watt High Power
600	780lm/9W	1060lm/12W
890	1170lm/12W	1590lm/16W
1182	1560lm/15W	2110lm/21W
1475	1950lm/19W	2640lm/25W
1765	2330lm/22W	3170lm/30W
2055	2720lm/28W	3700lm/37W

Lumen Values: Luminaire luminous flux at 4000K/CRI>80. Other configurations on request.

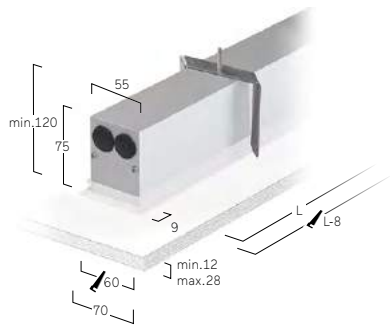

W Snow White
W Snow White



W Snow White
A Satin Silver



W Snow White
B Jet Black



W Snow White
G Satin Gold



W Snow White
K Satin Copper



W Snow White
H Anodic Champagne



W Snow White
A Satin Silver



A Satin Silver
W Snow White



B Jet Black
G Satin Gold

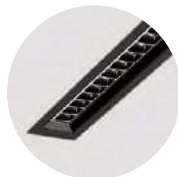

B Jet Black
B Jet Black

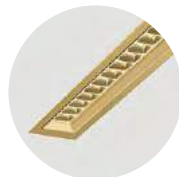

G Satin Gold
W Snow White



K Satin Copper
K Satin Copper

Matric Recessed



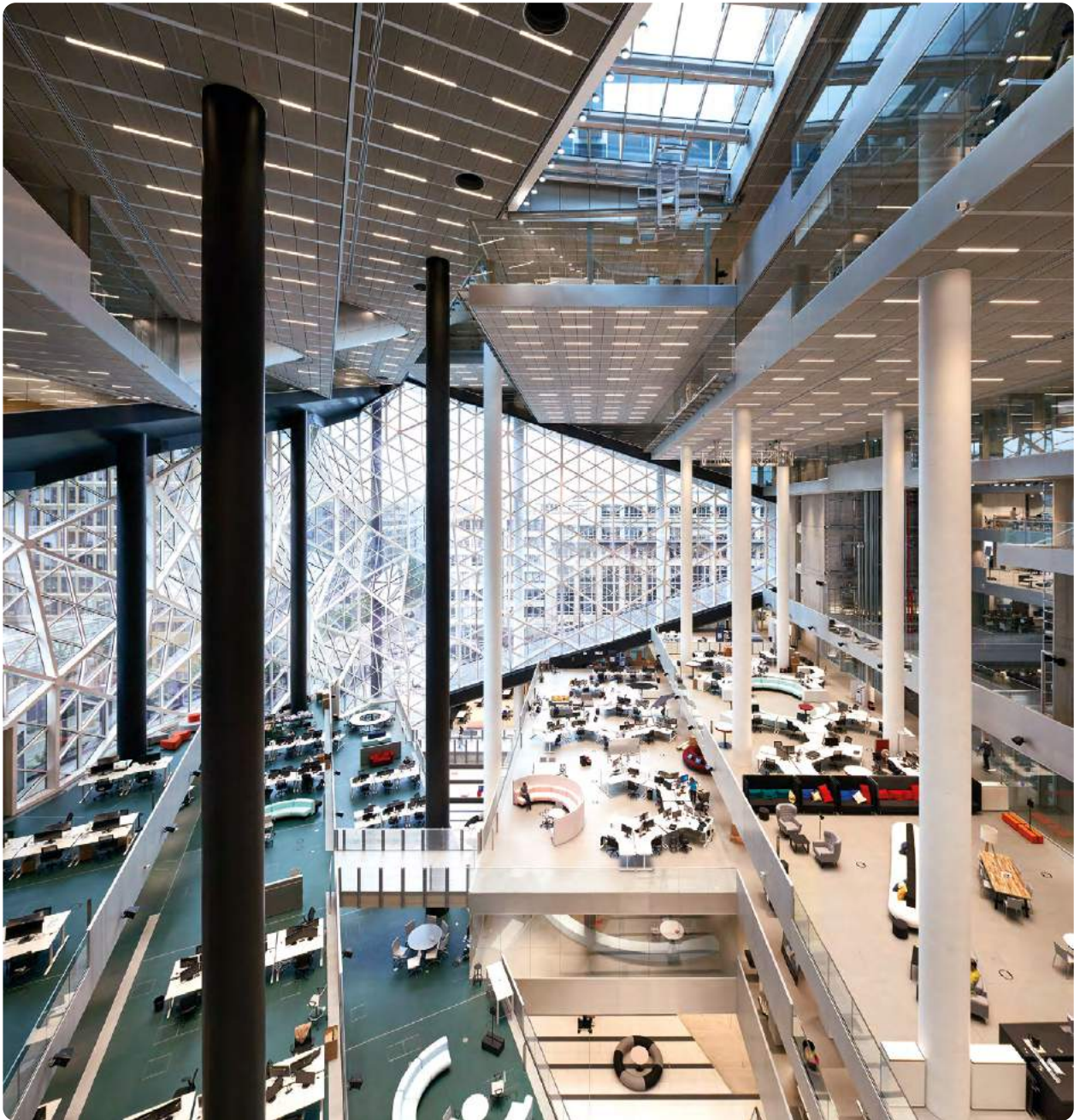

Axel Springer Campus, Berlin, Germany
Matric A1
Photography: Nils Koenning

Matric Recessed





Carga Global at Pialé Offices, Guatemala City, Guatemala
Matric F3, Matric G3
Architect: Valls Arquitectos, Lighting design: LUCE - Eli Porres
Photography: Alejandro de León

Matric Recessed



Satellite Office Opernplatz, Frankfurt, Germany
Matric F1
Photography: Moritz Bernoulli, www.satelliteoffice.de



Münsterland Hall, Münster, Germany
Matric F1
Realization and photography:
Scharkon Lichtkonzepte GmbH/Oliver Kahl Photography



AIB Headquarters, Dublin, Ireland
Matric M3
Photography: Donal Murphy Photography
Planning: dlight

Matric MX | System 40mm Recessed Frameless



DE LED-Einbauleuchte für rahmenlose Montage in Gipskartondecken. Rein direktstrahlend. Lichtkanal aus Aluminiumprofil mit 40mm Profilbreite. Millimetergenaue Längenfertigung nach Vorgabe möglich. Direktanteil über Präzisionslinsen mit Abblendraster für breite rotationssymmetrische Lichtstärkeverteilung bei gleichzeitig hoher Blendungsbegrenzung (UGR<19) für Office Anwendungen. Abblendraster in verschiedenen Farbkombinationen erhältlich. Microprismenoptik aus Spezialacrylglas mit optimierter Blendungsbegrenzung für Office-Anwendungen. Satinierter Opaldiffusor für Allgemeinbeleuchtung mit max. Transmissionsgrad und homogener Lichtpunktauflösung. Wallwasher für homogene Beleuchtung vertikaler Flächen. Konverter in Leuchtengehäuse integriert, wahlweise einfach schaltbar oder stufenlos dimmbar (DALI, Touch-Dim, Casambi). Farbtemperatur 2200K, 2700K, 3000K, 3500K, 4000K, 6500K oder Tunable White (2700-6500K). Binning initial \leq MacAdam 3. Farbwiedergabe CRI>80, CRI>90 oder Full Spectrum. Wahlweise Einbaurahmen für Installation mit Schattenfuge, alternativ Befestigungsset für Installation ohne Schattenfuge. Einbaurahmen oder Leuchtenprofil für Montage vorab lieferbar; restliche Leuchtenkomponenten zeitlich versetzt montierbar. Auf Anfrage: Integration von Stromschienen und Strahlern, Notlichtkomponenten, Sensortechnologie.

EN Recessed mounted LED luminaire for frameless installation in plasterboard ceilings. Direct only light distribution. Light channel made of aluminium profile with 40mm profile width. Bespoke lengths possible. Direct light using precision lenses with louvre for wide uniform symmetrical light distribution with high glare limitation (UGR<19) especially for workplaces. Louvre available in various colour finishes. Microprismatic screen made of special acrylic glass with optimized glare reduction especially for workplaces. Satin opal diffuser for general lighting with maximum transmittance and homogeneous lighting. Wallwasher for homogeneous illumination of vertical surfaces. Driver integrated into luminaire housing, optionally switchable or dimmable (DALI, Touch-Dim, Casambi). Colour temperature 2200K, 2700K, 3000K, 3500K, 4000K, 6500K or Tunable White (2700-6500K). Binning \leq MacAdam 3. Colour rendering CRI>80, CRI>90 or Full Spectrum. Optional mounting frame for installation with shadow gap, alternative mounting brackets for installation without shadow gap. Mounting frame or luminaire profile available in advance for mounting; other luminaire components can be mounted at different times. On request: Integration of tracks and spotlights, emergency lighting components, sensor technology.

L MXLWE-8 30E-L1194-B*

Product Family	L: Matric
Type	MX: Direct only
Optical System	A: Microprismatic, O: Opal Diffuser, G: Wallwasher, L: Lens Louvre*
Surface Finish	W: Snow White
Control Gear	E: On/Off, L: DALI, H: Touch-Dim, C: Casambi [L890-L2055], 6: DALI DT6 for TW [L1182-L2055], 8: DALI DT8 for TW [L890-L2055]
Colour Rendering	8: CRI>80, 9: CRI>90, F: Full Spectrum [except 2200K]
Colour Temperature	22: 2200K, 27: 2700K, 30: 3000K, 35: 3500K, 40: 4000K, 65: 6500K, TW: Tunable White 2700-6500K
Power	E: Low Power, M: Medium Power, H: High Power
Size	Luminaire Length in mm (Microprismatic, Opal Diffuser, Wallwasher): L600, L890, L1182, L1475, L1765, L2055 Luminaire Length in mm (Lens Louvre*): L665, L930, L1194, L1458, L1723, L1987
Lens Louvre*	W: Snow White, A: Satin Silver, B: Jet Black, H: Anodic Champagne, K: Satin Copper, G: Satin Gold
On Request	90° Corner, Midpin Downlights XD, Midpin Spotlights XM, 3-Phase Track, 48V-Track, Multisensor [L1182-L2055], Emergency Module [L1182-L2055]



Lens Louvre Direct			Microprismatic Direct			Opal Diffuser Direct			Wallwasher Direct		
L mm	Lumen/Watt Low Power	Lumen/Watt High Power	L mm	Lumen/Watt Low Power	Lumen/Watt High Power	L mm	Lumen/Watt Medium Power	Lumen/Watt High Power	L mm	Lumen/Watt Medium Power	Lumen/Watt High Power
665	1090lm/10W	2000lm/17W	600	610lm/7W	1100lm/12W	600	870lm/9W	1180lm/12W	600	840lm/11W	1070lm/14W
930	1520lm/13W	2790lm/24W	890	920lm/10W	1650lm/16W	890	1300lm/12W	1760lm/16W	890	1260lm/15W	1610lm/19W
1194	1960lm/16W	3590lm/30W	1182	1230lm/12W	2200lm/21W	1182	1730lm/15W	2350lm/21W	1182	1680lm/19W	2150lm/25W
1458	2390lm/19W	4390lm/37W	1475	1530lm/14W	2750lm/25W	1475	2160lm/19W	2940lm/25W	1475	2100lm/23W	2680lm/30W
1723	2830lm/23W	5190lm/43W	1765	1840lm/17W	3300lm/30W	1765	2600lm/22W	3530lm/30W	1765	2520lm/28W	3220lm/36W
1987	3260lm/26W	5990lm/49W	2055	2150lm/22W	3850lm/37W	2055	3030lm/28W	4110lm/37W	2055	2940lm/34W	3760lm/44W

Lumen Values: Luminaire luminous flux at 4000K/CRI>80. Other configurations on request.

Installation Housing with Shadow Gap

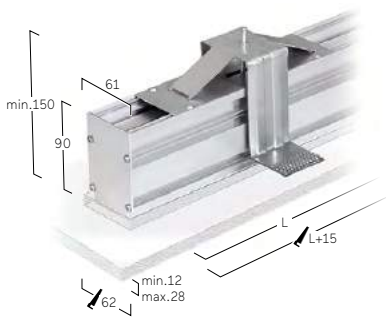

Matric FX | System 40mm Recessed Frame



DE LED-Einbauleuchte für Montage in gesägten Deckenöffnungen. Rein direktstrahlend. Lichtkanal mit umlaufendem Rahmen aus Aluminiumprofil. Optikbreite 40mm. Millimetergenaue Längenfertigung nach Vorgabe möglich. Oberfläche naturel oxidiert oder weiß, graphit, schwarz, champagner oder kupferfarben lackiert. Weitere Oberflächenoptionen siehe Lightnet-Surface-Collection oder RAL nach Wahl. Direktanteil über Präzisionslinsen mit Abblenderaster für breite rotationssymmetrische Lichtstärkeverteilung bei gleichzeitig hoher Blendungsbegrenzung ($UGR < 19$) für Office Anwendungen. Abblenderaster in verschiedenen Farbkombinationen erhältlich. Microprismenoptik aus Spezialacrylglas mit optimierter Blendungsbegrenzung für Office-Anwendungen. Satiniertes Opaldiffusor für Allgemeinbeleuchtung mit max. Transmissionsgrad und homogener Lichtpunktauflösung. Wallwasher für homogene Beleuchtung vertikaler Flächen. Konverter in Leuchtengehäuse integriert, wahlweise einfach schaltbar oder stufenlos dimmbar (DALI, Touch-Dim, Casambi). Farbtemperatur 2200K, 2700K, 3000K, 3500K, 4000K, 6500K oder Tunable White (2700-6500K). Binning initial \leq MacAdam 3. Farbwiedergabe $CRI > 80$, $CRI > 90$ oder Full Spectrum. Befestigungsset inklusive. Leuchtenprofil für Montage auf Anfrage vorab lieferbar; restliche Leuchtenkomponenten zeitlich versetzt montierbar. Auf Anfrage: Integration von Notlichtkomponenten, Sensortechnologie.

EN Recessed mounted LED luminaire for installation in ceiling cut-outs openings. Direct only light distribution. Light channel with surrounding frame made of aluminium profile. Optic width 40mm. Bespoke lengths possible. Surface natural anodised or white, graphite, black, champagne or copper coated. Further surface options see Lightnet-Surface-Collection or RAL of your choice. Direct light using precision lenses with louvre for wide uniform symmetrical light distribution with high glare limitation ($UGR < 19$) especially for workplaces. Louvre available in various finishes. Microprismatic screen made of special acrylic glass with optimized glare reduction especially for workplaces. Satin opal diffuser for general lighting with maximum transmittance and homogeneous lighting. Wallwasher for homogeneous illumination of vertical surfaces. Driver integrated into luminaire housing, optionally switchable or dimmable (DALI, Touch-Dim, Casambi). Colour temperature 2200K, 2700K, 3000K, 3500K, 4000K, 6500K or Tunable White (2700-6500K). Binning \leq MacAdam 3. Colour rendering $CRI > 80$, $CRI > 90$ or Full Spectrum. Mounting brackets included. Luminaire profile available in advance for mounting; other luminaire components can be mounted at different times. On request: Integration of emergency lighting components, sensor technology.

L FXLWE-8 30E-L1204-B*

Product Family	L: Matric
Type	FX: Direct only
Optical System	A: Microprismatic, O: Opal Diffuser, G: Wallwasher, L: Lens Louvre*
Surface Finish	W: Snow White, V: Ivory White, A: Satin Silver, E: Silver Anodised, U: Urban Graphite, B: Jet Black, H: Anodic Champagne, K: Satin Copper
Control Gear	E: On/Off, L: DALI, H: Touch-Dim, C: Casambi [L900-L2065], 6: DALI DT6 for TW [L1192-L2065], 8: DALI DT8 for TW [L900-L2065]
Colour Rendering	8: CRI>80, 9: CRI>90, F: Full Spectrum [except 2200K]
Colour Temperature	22: 2200K, 27: 2700K, 30: 3000K, 35: 3500K, 40: 4000K, 65: 6500K, TW: Tunable White 2700-6500K
Power	E: Low Power, M: Medium Power, H: High Power
Size	Luminaire Length in mm (Microprismatic, Opal Diffuser, Wallwasher): L610, L900, L1192, L1485, L1775, L2065 Luminaire Length in mm (Lens Louvre*): L675, L940, L1204, L1468, L1733, L1997
Lens Louvre*	W: Snow White, A: Satin Silver, B: Jet Black, H: Anodic Champagne, K: Satin Copper, G: Satin Gold
On Request	90° Corner, Midpin Downlights XD, Midpin Spotlights XM, 3-Phase Track, 48V-Track, Multisensor [L1192-L2065], Emergency Module [L1192-L2065]



Lens Louvre Direct			Microprismatic Direct			Opal Diffuser Direct			Wallwasher Direct		
L mm	Lumen/Watt Low Power	Lumen/Watt High Power	L mm	Lumen/Watt Low Power	Lumen/Watt High Power	L mm	Lumen/Watt Medium Power	Lumen/Watt High Power	L mm	Lumen/Watt Medium Power	Lumen/Watt High Power
675	1090lm/10W	2000lm/17W	610	610lm/7W	1100lm/12W	610	870lm/9W	1180lm/12W	610	840lm/11W	1070lm/14W
940	1520lm/13W	2790lm/24W	900	920lm/10W	1650lm/16W	900	1300lm/12W	1760lm/16W	900	1260lm/15W	1610lm/19W
1204	1960lm/16W	3590lm/30W	1192	1230lm/12W	2200lm/21W	1192	1730lm/15W	2350lm/21W	1192	1680lm/19W	2150lm/25W
1468	2390lm/19W	4390lm/37W	1485	1530lm/14W	2750lm/25W	1485	2160lm/19W	2940lm/25W	1485	2100lm/23W	2680lm/30W
1733	2830lm/23W	5190lm/43W	1775	1840lm/17W	3300lm/30W	1775	2600lm/22W	3530lm/30W	1775	2520lm/28W	3220lm/36W
1997	3260lm/26W	5990lm/49W	2065	2150lm/22W	3850lm/37W	2065	3030lm/28W	4110lm/37W	2065	2940lm/34W	3760lm/44W

Lumen Values: Luminaire luminous flux at 4000K/CRI>80. Other configurations on request.

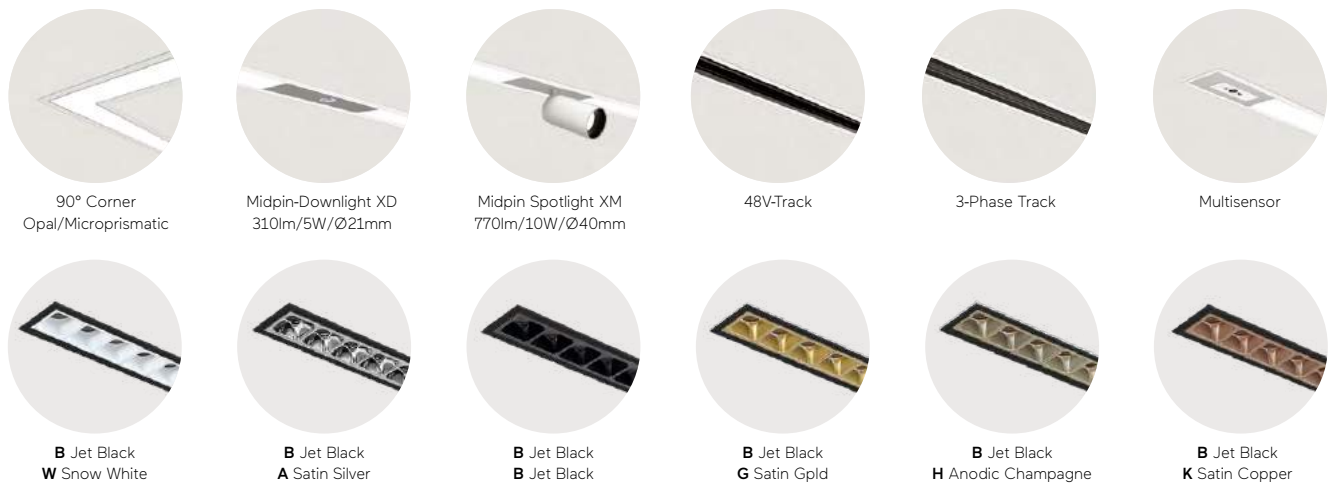
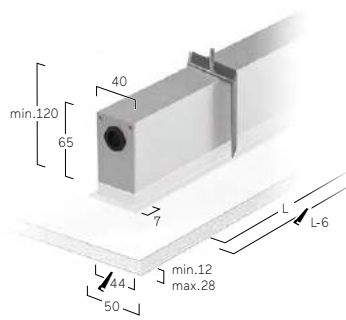

Matric M3 | System 55mm Recessed Frameless

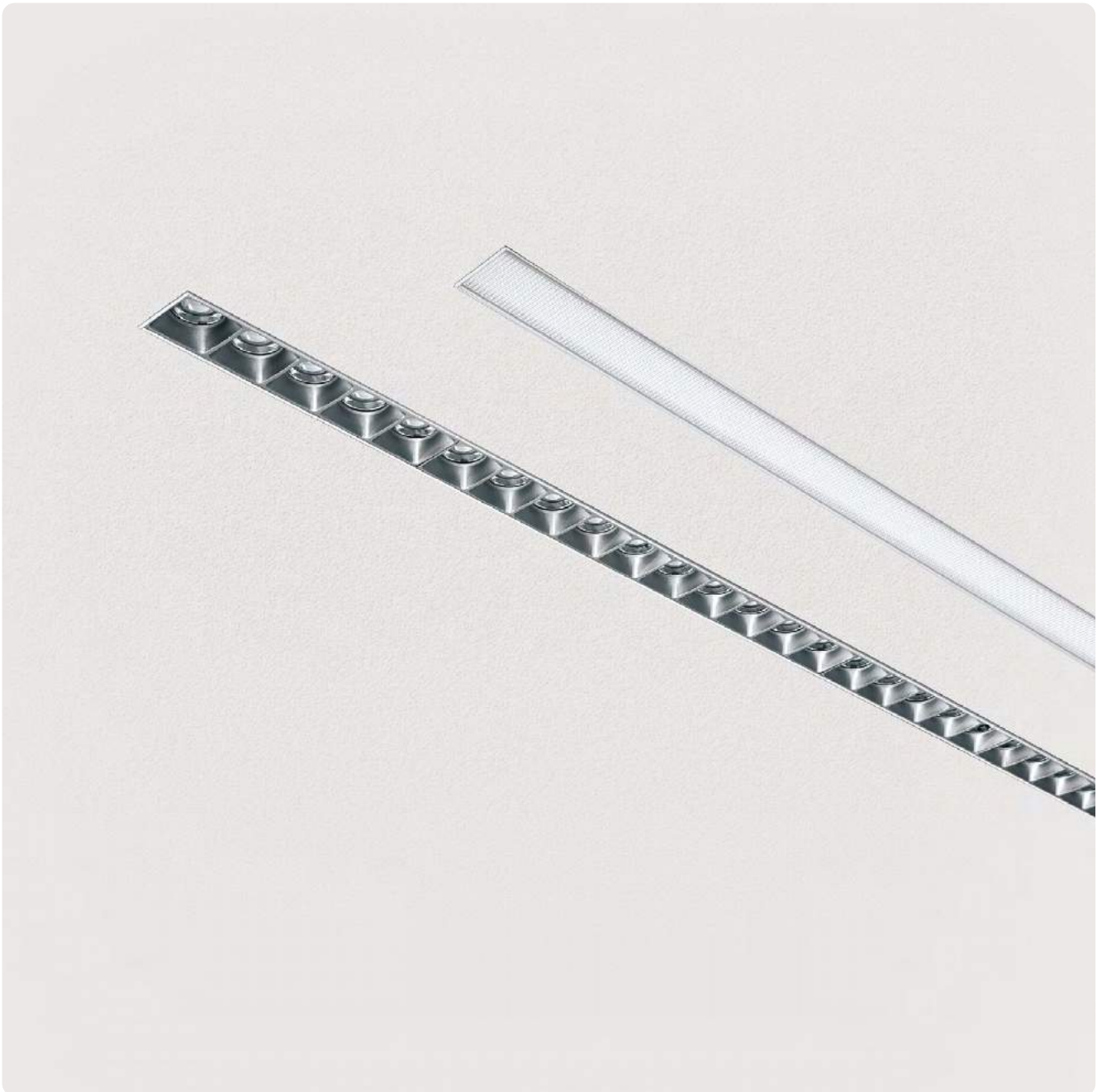

DE LED-Einbauleuchte für rahmenlose Montage in Gipskartondecken. Rein direktstrahlend. Lichtkanal aus Aluminiumprofil mit 55mm Profilbreite. Millimetergenaue Längenfertigung nach Vorgabe möglich. Direktanteil über Präzisionslinsen mit Abblendraster für breite rotationssymmetrische Lichtstärkeverteilung bei gleichzeitig hoher Blendungsbegrenzung (UGR<19) für Office Anwendungen. Abblendraster in verschiedenen Farbkombinationen erhältlich. Microprismenoptik aus Spezialacrylglas mit optimierter Blendungsbegrenzung für Office-Anwendungen. Satinierter Opaldiffusor für Allgemeinbeleuchtung mit max. Transmissionsgrad und homogener Lichtpunktauflösung. Wallwasher für homogene Beleuchtung vertikaler Flächen. Konverter in Leuchtgehäuse integriert, wahlweise einfach schaltbar oder stufenlos dimmbar (DALI, Touch-Dim, Casambi). Farbtemperatur 2200K, 2700K, 3000K, 3500K, 4000K, 6500K oder Tunable White (2700-6500K). Binning initial \leq MacAdam 3. Farbwiedergabe CRI>80, CRI>90 oder Full Spectrum. Wahlweise Einbaurahmen für Installation mit Schattenfuge, alternativ Befestigungsset für Installation ohne Schattenfuge. Einbaurahmen oder Leuchtenprofil für Montage vorab lieferbar; restliche Leuchtenkomponenten zeitlich versetzt montierbar. Auf Anfrage: Integration von Stromschienen und Strahlern, Notlichtkomponenten, Sensortechnologie.

EN Recessed mounted LED luminaire for frameless installation in plasterboard ceilings. Direct only light distribution. Light channel made of 55mm wide aluminium profile. Bespoke lengths possible. Direct light using precision lenses with louvre for wide uniform symmetrical light distribution with high glare limitation (UGR<19) especially for workplaces. Louvre available in various colour finishes. Microprismatic screen made of special acrylic glass with optimized glare reduction especially for workplaces. Satin opal diffuser for general lighting with maximum transmittance and homogeneous lighting. Wallwasher for homogeneous illumination of vertical surfaces. Driver integrated into luminaire housing, optionally switchable or dimmable (DALI, Touch-Dim, Casambi). Colour temperature 2200K, 2700K, 3000K, 3500K, 4000K, 6500K or Tunable White (2700-6500K). Binning \leq MacAdam 3. Colour rendering CRI>80, CRI>90 or Full Spectrum. Optional mounting frame for installation with shadow gap, alternative mounting brackets for installation without shadow gap. Mounting frame or luminaire profile available in advance for mounting; other luminaire components can be mounted at different times. On request: Integration of tracks and spotlights, emergency lighting components, sensor technology.

L M3 LWE - 8 30 E - L1252-FW*

Product Family	L: Matric
Type	M3: Direct only
Optical System	A: Microprismatic, O: Opal Diffuser, G: Wallwasher, L: Lens Louvre*, D: Opal Diffuser (Polycarbonate)**
Surface Finish	W: Snow White
Control Gear	E: On/Off, L: DALI, H: Touch-Dim, C: Casambi, 6: DALI DT6 for TW [L1475-L2055], 8: DALI DT8 for TW [L809-L2055]
Colour Rendering	8: CRI>80, 9: CRI>90, F: Full Spectrum [except 2200K]
Colour Temperature	22: 2200K, 27: 2700K, 30: 3000K, 35: 3500K, 40: 4000K, 65: 6500K, TW: Tunable White 2700-6500K
Power	E: Low Power, M: Medium Power, H: High Power
Size	Luminaire Length in mm (Microprismatic, Opal Diffuser, Wallwasher): L600, L890, L1182, L1475, L1765, L2055 Luminaire Length in mm (Lens Louvre*): L752, L1002, L1252, L1502, L1752, L2002
Installation	F: Installation Housing, B: Installation Brackets
Lens Louvre*	W: Snow White, A: Satin Silver, B: Jet Black, H: Anodic Champagne, K: Satin Copper, G: Satin Gold
On Request	90° Corner, Midpin Downlights XD, Midpin Spotlights XM, 3-Phase Track, Multisensor [L1182-L2055], Emergency Module [L1182-L2055]

*Opal Diffuser made of sustainable TruCircle Polycarbonate / Fire Rated - Glow wire flammability Index 950°C EN60695-2-12 / Tp(a). Luminous flux reduction of 10%



Lens Louvre | Direct

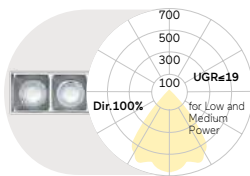

Microprismatic | Direct

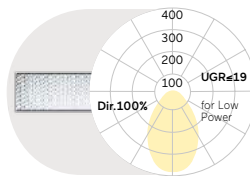

Opal Diffuser | Direct

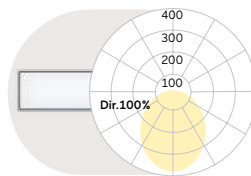

Wallwasher | Direct

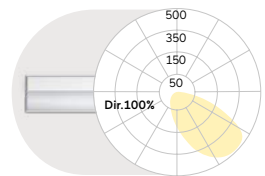

L mm	Lumen/Watt			L mm	Lumen/Watt			L mm	Lumen/Watt			L mm	Lumen/Watt	
	Low Power	Medium Power	High Power		Low Power	Medium Power	High Power		Low Power	Medium Power	High Power		Medium Power	High Power
752	1370lm/11W	1870lm/15W	2690lm/22W	600	820lm/9W	1110lm/12W	1570lm/17W	600	900lm/9W	1210lm/12W	1720lm/17W	600	750lm/11W	1030lm/15W
1002	1830lm/14W	2500lm/19W	3590lm/28W	890	1230lm/12W	1660lm/16W	2350lm/24W	890	1350lm/12W	1820lm/16W	2580lm/24W	890	1130lm/15W	1540lm/21W
1252	2290lm/16W	3120lm/23W	4500lm/34W	1182	1640lm/16W	2210lm/21W	3130lm/31W	1182	1790lm/16W	2430lm/21W	3440lm/31W	1182	1500lm/19W	2060lm/27W
1502	2750lm/19W	3750lm/27W	5380lm/40W	1475	2050lm/19W	2770lm/26W	3920lm/37W	1475	2240lm/19W	3030lm/26W	4300lm/37W	1475	1880lm/23W	2570lm/33W
1752	3200lm/22W	4370lm/31W	6280lm/46W	1765	2450lm/22W	3320lm/30W	4700lm/44W	1765	2690lm/22W	3640lm/30W	5160lm/44W	1765	2250lm/28W	3090lm/39W
2002	3660lm/25W	5000lm/35W	7180lm/53W	2055	2860lm/28W	3870lm/38W	5490lm/54W	2055	3140lm/28W	4250lm/38W	6020lm/54W	2055	2630lm/34W	3600lm/47W

Lumen Values: Luminaire luminous flux at 4000K/CRI>80. Other configurations on request.

B: Installation Bracket without Shadow Gap



F: Installation Housing with Shadow Gap

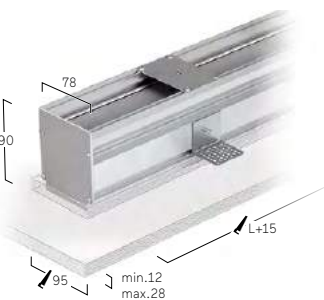

90° Corner
Opal/Microprismatic



Midpin-Downlight XD
770lm/10W/Ø40mm



Midpin Spotlight XM
770lm/10W/Ø40mm



3-Phase Track



Multisensor

Matric F3 | System 55mm Recessed Frame



DE LED-Einbauleuchte für Montage in gesägten Deckenöffnungen. Rein direktstrahlend. Lichtkanal mit umlaufendem Rahmen aus Aluminiumprofil. Optikbreite 55mm. Millimetergenaue Längenfertigung nach Vorgabe möglich. Oberfläche natureloxiert oder weiß, graphit, schwarz, champagner oder kupferfarben lackiert. Weitere Oberflächenoptionen siehe Lightnet-Surface-Collection oder RAL nach Wahl. Direktanteil über Präzisionslinsen mit Abblendraaster für breite rotationssymmetrische Lichtstärkeverteilung bei gleichzeitig hoher Blendungsbegrenzung ($UGR < 19$) für Office Anwendungen. Abblendraaster in verschiedenen Farbkombinationen erhältlich. Microprismenoptik aus Spezialacrylglas mit optimierter Blendungsbegrenzung für Office-Anwendungen. Satiniertes Opaldiffusor für Allgemeinbeleuchtung mit max. Transmissionsgrad und homogener Lichtpunktauflösung. Wallwasher für homogene Beleuchtung vertikaler Flächen. Konverter in Leuchtengehäuse integriert, wahlweise einfach schaltbar oder stufenlos dimmbar (DALI, Touch-Dim, Casambi). Farbtemperatur 2200K, 2700K, 3000K, 3500K, 4000K, 6500K oder Tunable White (2700-6500K). Binning initial \leq MacAdam 3. Farbwiedergabe $CRI > 80$, $CRI > 90$ oder Full Spectrum. Befestigungsset inklusive. Leuchtenprofil für Montage auf Anfrage vorab lieferbar; restliche Leuchtenkomponenten zeitlich versetzt montierbar. Auf Anfrage: Integration von Notlichtkomponenten, Sensortechnologie.

EN Recessed mounted LED luminaire for installation in ceiling cut-outs openings. Direct only light distribution. Light channel with surrounding frame made of aluminium profile. Optic width 55mm. Bespoke lengths possible. Surface natural anodised or white, graphite, black, champagne or copper coated. Further surface options see Lightnet-Surface-Collection or RAL of your choice. Direct light using precision lenses with louvre for wide uniform symmetrical light distribution with high glare limitation ($UGR < 19$) especially for workplaces. Louvre available in various colour finishes. Microprismatic screen made of special acrylic glass with optimized glare reduction especially for workplaces. Satin opal diffuser for general lighting with maximum transmittance and homogeneous lighting. Wallwasher for homogeneous illumination of vertical surfaces. Driver integrated into luminaire housing, optionally switchable or dimmable (DALI, Touch-Dim, Casambi). Colour temperature 2200K, 2700K, 3000K, 3500K, 4000K, 6500K or Tunable White (2700-6500K). Binning \leq MacAdam 3. Colour rendering $CRI > 80$, $CRI > 90$ or Full Spectrum. Mounting brackets included. Luminaire profile available in advance for mounting; other luminaire components can be mounted at different times. On request: Integration of emergency lighting components, sensor technology.

LF3LEE-830E-L1268-W*

Product Family	L: Matric
Type	F3: Direct only
Optical System	A: Microprismatic, O: Opal Diffuser, G: Wallwasher, L: Lens Louvre*, D: Opal Diffuser (Polycarbonate)**
Surface Finish	W: Snow White, V: Ivory White, E: Silver Anodised, U: Urban Graphite, B: Jet Black, H: Anodic Champagne, K: Satin Copper
Control Gear	E: On/Off, L: DALI, H: Touch-Dim, C: Casambi, 6: DALI DT6 for TW [L1198-L2075], 8: DALI DT8 for TW [L905-L2075]
Colour Rendering	8: CRI>80, 9: CRI>90, F: Full Spectrum [except 2200K]
Colour Temperature	22: 2200K, 27: 2700K, 30: 3000K, 35: 3500K, 40: 4000K, 65: 6500K, TW: Tunable White 2700-6500K
Power	E: Low Power, M: Medium Power, H: High Power
Size	Luminaire Length in mm (Microprismatic, Opal Diffuser, Wallwasher): L615, L905, L1198, L1490, L1780, L2075 Luminaire Length in mm (Lens Louvre*): L768, L1018, L1268, L1518, L1768, L2018
Lens Louvre*	W: Snow White, A: Satin Silver, B: Jet Black, H: Anodic Champagne, K: Satin Copper, G: Satin Gold
On Request	90° Corner, Midpin Downlights XD, Midpin Spotlights XM, 3-Phase Track, Multisensor [L1198-L2075], Emergency Module [L1198-L2075]

**Opal Diffuser made of sustainable TruCircle Polycarbonate / Fire Rated - Glow wire flammability Index 950°C EN60695-2-12 / Tp(a). Luminous flux reduction of 10%



Lens Louvre | Direct

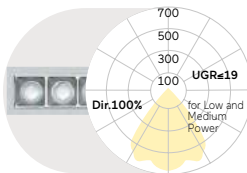

Microprismatic | Direct

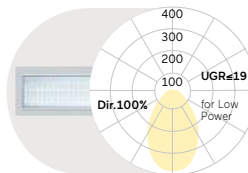

Opal Diffuser | Direct

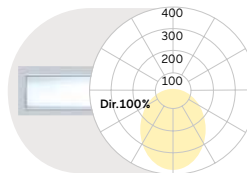

Wallwasher | Direct

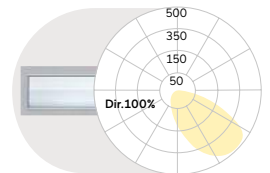

L mm	Lumen/Watt Low Power	Lumen/Watt Medium Power	Lumen/Watt High Power	L mm	Lumen/Watt Low Power	Lumen/Watt Medium Power	Lumen/Watt High Power	L mm	Lumen/Watt Low Power	Lumen/Watt Medium Power	Lumen/Watt High Power	L mm	Lumen/Watt Medium Power	Lumen/Watt High Power
768	1370lm/11W	1870lm/15W	2690lm/22W	615	820lm/9W	1110lm/12W	1570lm/17W	615	900lm/9W	1210lm/12W	1720lm/17W	615	750lm/11W	1030lm/15W
1018	1830lm/14W	2500lm/19W	3590lm/28W	905	1230lm/12W	1660lm/16W	2350lm/24W	905	1350lm/12W	1820lm/16W	2580lm/24W	905	1130lm/15W	1540lm/21W
1268	2290lm/16W	3120lm/23W	4500lm/34W	1198	1640lm/16W	2210lm/21W	3130lm/31W	1198	1790lm/16W	2430lm/21W	3440lm/31W	1198	1500lm/19W	2060lm/27W
1518	2750lm/19W	3750lm/27W	5380lm/40W	1490	2050lm/19W	2770lm/26W	3920lm/37W	1490	2240lm/19W	3030lm/26W	4300lm/37W	1490	1880lm/23W	2570lm/33W
1768	3200lm/22W	4370lm/31W	6280lm/46W	1780	2450lm/22W	3320lm/30W	4700lm/44W	1780	2690lm/22W	3640lm/30W	5160lm/44W	1780	2250lm/28W	3090lm/39W
2018	3660lm/25W	5000lm/35W	7180lm/53W	2075	2860lm/28W	3870lm/38W	5490lm/54W	2075	3140lm/28W	4250lm/38W	6020lm/54W	2075	2630lm/34W	3600lm/47W

Lumen Values: Luminaire luminous flux at 4000K/CRI>80. Other configurations on request.

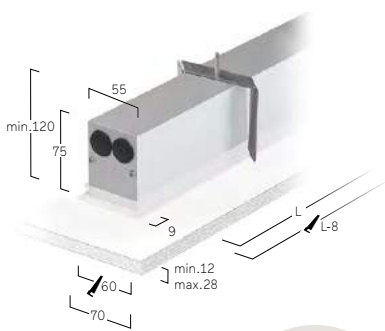

90° Corner
Opal/Microprismatic



Midpin-Downlight XD
770lm/10W/Ø40mm



Midpin Spotlight XM
770lm/10W/Ø40mm



3-Phase Track



Multisensor



W Snow White

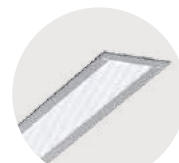

A Satin Silver



U Urban Graphite



B Jet Black



H Anodic Champagne



K Satin Copper

Matric M5 | System 81mm Recessed Frameless



DE LED-Einbauleuchte für rahmenlose Montage in Gipskartondecken. Rein direktstrahlend. Lichtkanal aus Aluminiumprofil mit 81mm Profildbreite. Millimetergenaue Längenfertigung nach Vorgabe möglich. Microprismenoptik aus Spezialacrylglas und Satin-Louvre aus Aluminium mit optimierter Blendungsbegrenzung speziell für Office-Anwendungen. Satinierter Opaldiffusor für Allgemeinbeleuchtung mit max. Transmissionsgrad und homogener Lichtpunktauflösung. Wallwasher für homogene Beleuchtung vertikaler Flächen. Konverter in Leuchtengehäuse integriert, wahlweise einfach schaltbar oder stufenlos dimmbar (DALI, Touch-Dim, Casambi). Farbtemperaturen 2200K, 2700K, 3000K, 3500K, 4000K, 6500K oder Tunable White (2700-6500K). Binning initial \leq MacAdam 3. Farbwiedergabe CRI $>$ 80, CRI $>$ 90 oder Full Spectrum. Wahlweise Einbaurahmen für Installation mit Schattenfuge, alternativ Befestigungsset für Installation ohne Schattenfuge. Einbaurahmen oder Leuchtenprofil für Montage vorab lieferbar; restliche Leuchtenkomponenten zeitlich versetzt montierbar. Auf Anfrage: Integration von Strahlern, Notlichtkomponenten, Sensortechnologie.

EN Recessed mounted LED luminaire for frameless installation in plasterboard ceilings. Direct only light distribution. Light channel made of 81mm wide aluminium profile. Bespoke lengths possible. Microprismatic screen made of special acrylic glass and satin Louvre made of aluminum with optimized glare reduction especially for workplaces. Satin opal diffuser for general lighting with maximum transmittance and homogeneous lighting. Wallwasher for homogeneous illumination of vertical surfaces. Driver integrated into luminaire housing, optionally switchable or dimmable (DALI, Touch-Dim, Casambi). Colour temperature 2200K, 2700K, 3000K, 3500K, 4000K, 6500K or Tunable White (2700-6500K). Binning \leq MacAdam 3. Colour rendering CRI $>$ 80, CRI $>$ 90 or Full Spectrum. Optional mounting frame for installation with shadow gap, alternative mounting brackets for installation without shadow gap. Mounting frame or luminaire profile available in advance for mounting; other luminaire components can be mounted at different times. On request: Integration of spotlights, emergency lighting components, sensor technology.

LM50WE - 830M - L890-F

Product Family **L:** Matric

Type **M5:** Direct only

Optical System **A:** Microprismatic, **O:** Opal Diffuser, **M:** Satin Louvre, **G:** Wallwasher

Surface Finish **W:** Snow White

Control Gear **E:** On/Off, **L:** DALI, **H:** Touch-Dim, **C:** Casambi, **6:** DALI DT6 for TW [L1182-L2055], **8:** DALI DT8 for TW [L890-L2055]

Colour Rendering **8:** CRI>80, **9:** CRI>90, **F:** Full Spectrum [except 2200K]

Colour Temperature **22:** 2200K, **27:** 2700K, **30:** 3000K, **35:** 3500K, **40:** 4000K, **65:** 6500K, **TW:** Tunable White 2700-6500K

Power **E:** Low Power, **M:** Medium Power, **H:** High Power

Size Luminaire Length in mm: **L600, L890, L1182, L1475, L1765, L2055**

Installation **F:** Installation Housing, **B:** Installation Brackets

On Request 90° Corner, Midpin Downlights XD, Midpin Spotlights XM, Midpoint Spotlights XM, 3-Phase Track, 48V-Track, Multisensor [L1182-L2055], Emergency Module [L1182-L2055]

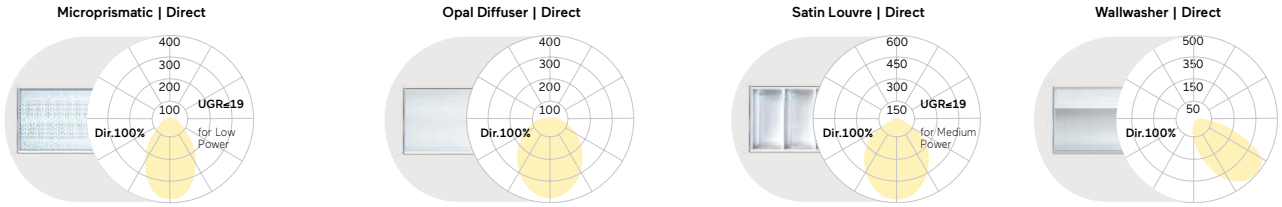

L mm	Lumen/Watt Low Power	Lumen/Watt Medium Power	Lumen/Watt High Power	L mm	Lumen/Watt Low Power	Lumen/Watt Medium Power	Lumen/Watt High Power	L mm	Lumen/Watt Medium Power	Lumen/Watt High Power	L mm	Lumen/Watt High Power
600	1000lm/11W	1380lm/15W	2010lm/21W	600	1180lm/11W	1620lm/15W	2360lm/21W	600	1270lm/15W	1840lm/21W	600	1180lm/15W
890	1510lm/15W	2070lm/21W	3020lm/31W	890	1760lm/15W	2430lm/21W	3530lm/31W	890	1900lm/21W	2770lm/31W	890	1770lm/21W
1182	2010lm/19W	2760lm/26W	4020lm/40W	1182	2350lm/19W	3230lm/26W	4710lm/40W	1182	2530lm/26W	3690lm/40W	1182	2360lm/27W
1475	2510lm/23W	3450lm/32W	5030lm/49W	1475	2940lm/23W	4040lm/32W	5890lm/49W	1475	3170lm/32W	4610lm/49W	1475	2950lm/33W
1765	3010lm/27W	4140lm/38W	6030lm/59W	1765	3530lm/27W	4850lm/38W	7070lm/59W	1765	3800lm/38W	5530lm/59W	1765	3540lm/39W
2055	3510lm/34W	4830lm/47W	7040lm/71W	2055	4120lm/34W	5660lm/47W	8240lm/71W	2055	4430lm/47W	6450lm/71W	2055	4130lm/47W

Lumen Values: Luminaire luminous flux at 4000K/CRI>80. Other configurations on request.

B: Installation Bracket without Shadow Gap

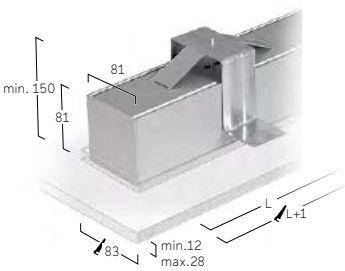

F: Installation Housing with Shadow Gap

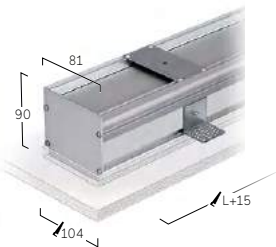

90° Corner
Opal/Microprismatic



Midpin-Downlight XD
770lm/10W/Ø40mm



Midpin Spotlight XM
770lm/10W/Ø40mm



Midpoint Spotlight XM
1000lm/19W-3000lm/31W
Ø90mm



Multisensor

Matric F5 | System 81mm Recessed Frame



DE LED-Einbauleuchte für Montage in gesägten Deckenöffnungen. Rein direktstrahlend. Lichtkanal mit umlaufendem Rahmen aus Aluminiumprofil. Optikbreite 81mm. Millimetergenaue Längenfertigung nach Vorgabe möglich. Oberfläche natureloxiiert oder weiß, graphit, schwarz, champagner oder kupferfarben lackiert. Weitere Oberflächenoptionen siehe Lightnet-Surface-Collection oder RAL nach Wahl. Microprismenoptik aus Spezialacrylglas und Satin-Louvre aus Aluminium mit optimierter Blendungsbegrenzung speziell für Office-Anwendungen. Satinierter Opaldiffusor für Allgemeinbeleuchtung mit max. Transmissionsgrad und homogener Lichtpunktauflösung. Wallwasher für homogene Beleuchtung vertikaler Flächen. Konverter in Leuchtgehäuse integriert, wahlweise einfach schaltbar oder stufenlos dimmbar (DALI, Touch-Dim, Casambi). Farbtemperaturen 2200K, 2700K, 3000K, 3500K, 4000K, 6500K oder Tunable White (2700K-6500K). Binning initial \leq MacAdam 3. Farbwiedergabe CRI $>$ 80, CRI $>$ 90 oder Full Spectrum. Befestigungsset inklusive. Leuchtenprofil für Montage auf Anfrage vorab lieferbar; restliche Leuchtenkomponenten zeitlich versetzt montierbar. Auf Anfrage: Integration von Notlichtkomponenten, Sensortechnologie sowie Vielzahl weiterer Optionen.

EN Recessed mounted LED luminaire for installation in ceiling cut-outs openings. Direct only light distribution. Light channel with surrounding frame made of aluminium profile. Optic width 81mm. Bepoke lengths possible. Surface natural anodised or white, graphite, black, champagne or copper coated. Further surface options see Lightnet-Surface-Collection or RAL of your choice. Microprismatic screen made of special acrylic glass and satin Louvre made of aluminum with optimized glare reduction especially for workplaces Satin opal diffuser for general lighting with maximum transmittance and homogeneous lighting. Wallwasher for homogeneous illumination of vertical surfaces. Driver integrated into luminaire housing, optionally switchable or dimmable (DALI, Touch-Dim, Casambi). Colour temperature 2200K, 2700K, 3000K, 3500K, 4000K, 6500K or Tunable White (2700K-6500K). Binnings \leq MacAdam 3. Colour rendering CRI $>$ 80, CRI $>$ 90 or Full Spectrum. Mounting brackets included. Luminaire profile available in advance for mounting; other luminaire components can be mounted at different times. On request: Integration of emergency lighting components, sensor technology and many other options.

LF50WE - 830M - L905

- Product Family **L:** Matric
- Type **F5:** Direct only
- Optical System **A:** Microprismatic, **O:** Opal Diffuser, **M:** Satin Louvre, **G:** Wallwasher
- Surface Finish **W:** Snow White, **V:** Ivory White, **E:** Silver Anodised, **U:** Urban Graphite, **B:** Jet Black, **H:** Anodic Champagne, **K:** Satin Copper
- Control Gear **E:** On/Off, **L:** DALI, **H:** Touch-Dim, **C:** Casambi, **6:** DALI DT6 for TW [L1198-L2075], **8:** DALI DT8 for TW [L905-L2075]
- Colour Rendering **8:** CRI>80, **9:** CRI>90, **F:** Full Spectrum [except 2200K]
- Colour Temperature **22:** 2200K, **27:** 2700K, **30:** 3000K, **35:** 3500K, **40:** 4000K, **65:** 6500K, **TW:** Tunable White 2700-6500K
- Power **E:** Low Power, **M:** Medium Power, **H:** High Power
- Size Luminaire Length in mm: **L615, L905, L1198, L1490, L1780, L2075**
- On Request 90° Corner, Midpin Downlights XD, Midpin Spotlights XM, Midpoint Spotlights XM, 3-Phase Track, 48V-Track, Multisensor [L1198-L2075], Emergency Module [L1198-L2075]

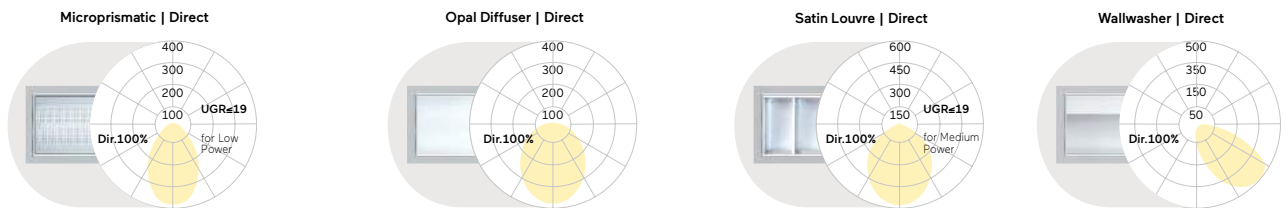

L mm	Microprismatic Direct			Opal Diffuser Direct			Satin Louvre Direct		Wallwasher Direct	
	Lumen/Watt Low Power	Lumen/Watt Medium Power	Lumen/Watt High Power	Lumen/Watt Low Power	Lumen/Watt Medium Power	Lumen/Watt High Power	Lumen/Watt Medium Power	Lumen/Watt High Power	Lumen/Watt High Power	
615	1000lm/11W	1380lm/15W	2010lm/21W	1180lm/11W	1620lm/15W	2360lm/21W	1270lm/15W	1840lm/21W	1180lm/15W	
905	1510lm/15W	2070lm/21W	3020lm/31W	1760lm/15W	2430lm/21W	3530lm/31W	1900lm/21W	2770lm/31W	1770lm/21W	
1198	2010lm/19W	2760lm/26W	4020lm/40W	2350lm/19W	3230lm/26W	4710lm/40W	2530lm/26W	3690lm/40W	2360lm/27W	
1490	2510lm/23W	3450lm/32W	5030lm/49W	2940lm/23W	4040lm/32W	5890lm/49W	3170lm/32W	4610lm/49W	2950lm/33W	
1780	3010lm/27W	4140lm/38W	6030lm/59W	3530lm/27W	4850lm/38W	7070lm/59W	3800lm/38W	5530lm/59W	3540lm/39W	
2075	3510lm/34W	4830lm/47W	7040lm/71W	4120lm/34W	5660lm/47W	8240lm/71W	4430lm/47W	6450lm/71W	4130lm/47W	

Lumen Values: Luminaire luminous flux at 4000K/CRI>80. Other configurations on request.

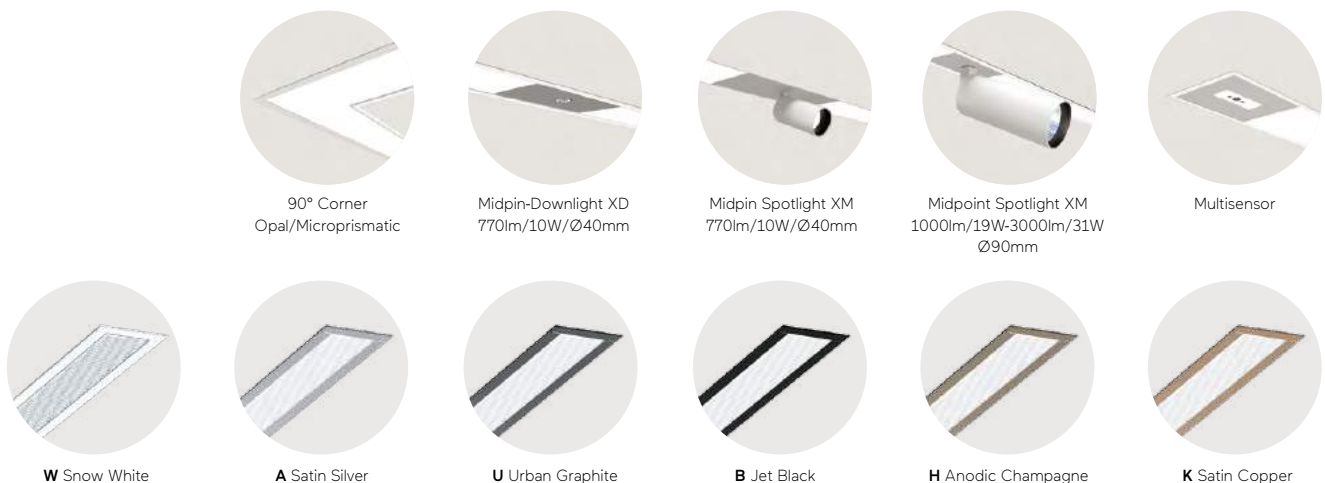
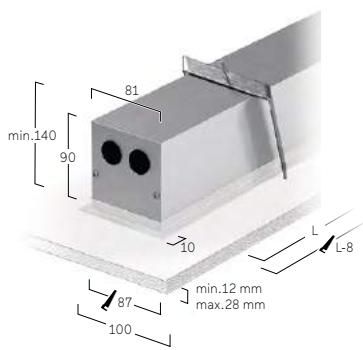



Basic Max A1 IP54 |
Surface
512



Matric AX IP54 |
System 40mm Surface
516

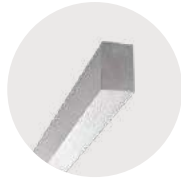

Matric A3 IP54 |
System 55mm Surface
518



Matric FX IP54 | System
40mm Recessed Frame
520



Matric F3 IP54 | System
55mm Recessed Frame
522

Höhere Schutzart |
Higher Protection

Basic Max A1 IP54 | Surface



DE LED-Anbauleuchte für Wand- und Deckenmontage. Rein direktstrahlend. Leuchtenkörper aus Aluminiumprofil mit in 4 verschiedenen Durchmessern von 300 bis 600mm – bei gleichbleibender Bauhöhe 75mm. Oberfläche weiß, silber, graphit, schwarz, champagner oder kupferfarben lackiert. Weitere Oberflächenoptionen siehe Lightnet-Surface-Collection oder RAL nach Wahl. Opaldiffusor aus satiniertem Acrylglas. Konverter in Leuchtengehäuse integriert, wahlweise einfach schaltbar oder stufenlos dimmbar (DALI, Touch-Dim). Farbtemperatur 2200K, 2700K, 3000K, 3500K, 4000K, 6500K oder Tunable White (2700-6500K). Binning initial \leq MacAdam 3. Farbwiedergabe CRI $>$ 80, CRI $>$ 90 oder Full Spectrum. Schutzart IP54.

EN LED surface-mounted luminaire for walls and ceilings. Direct only light distribution. Luminaire body made of aluminum profile in 4 different diameters from 300mm to 600mm – with overall height of 75mm. Surface white, silver, graphite, black, champagne or copper coated. Further surface options see Lightnet-Surface-Collection or RAL of your choice. Opal diffuser made of acrylic glass. Driver integrated into luminaire housing, optionally switchable or dimmable (DALI, Touch-Dim). Colour temperature 2200K, 2700K, 3000K, 3500K, 4000K, 6500K or Tunable White (2700-6500K). Binning \leq MacAdam 3. Colour rendering CRI $>$ 80, CRI $>$ 90 or Full Spectrum. Ingress protection IP54.

BA1 O S L - 8 30 M-D300-IP54

Product Family	B: Basic
Type	A1: Direct only
Optical System	O: Opal Diffuser
Surface Finish	W: Snow White, V: Ivory White, S: Radiant Silver, U: Urban Graphite, B: Jet Black, H: Anodic Champagne, K: Satin Copper
Control Gear	E: On/Off, L: DALI, H: Touch-Dim, 6: DALI DT6 for TW, 8: DALI DT8 for TW, C: Casambi
Colour Rendering	8: CRI>80, 9: CRI>90, F: Full Spectrum [except 2200K]
Colour Temperature	22: 2200K, 27: 2700K, 30: 3000K, 35: 3500K, 40: 4000K, 65: 6500K, TW: Tunable White 2700-6500K [D400-D600]
Power	E: Low Power, M: Medium Power,
Size	Luminaire Diameter in mm: D300, D400, D500, D600
Protection	IP54



Opal Diffuser | Direct

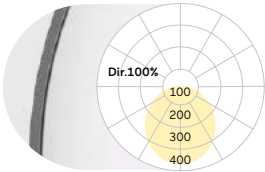

D mm	Lumen/Watt Low Power	Lumen/Watt Medium Power
300	910lm/8W	1780lm/14W
400	1790lm/13W	3690lm/29W
500	2550lm/18W	5010lm/35W
600	3980lm/28W	7470lm/52W

Lumen Values: Luminaire luminous flux at 4000K/CRI>80. Other configurations on request.

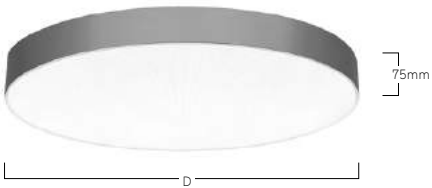

Matric Higher Protection



73 Miller Street, Sydney, Australia
Matric A3 Special Version

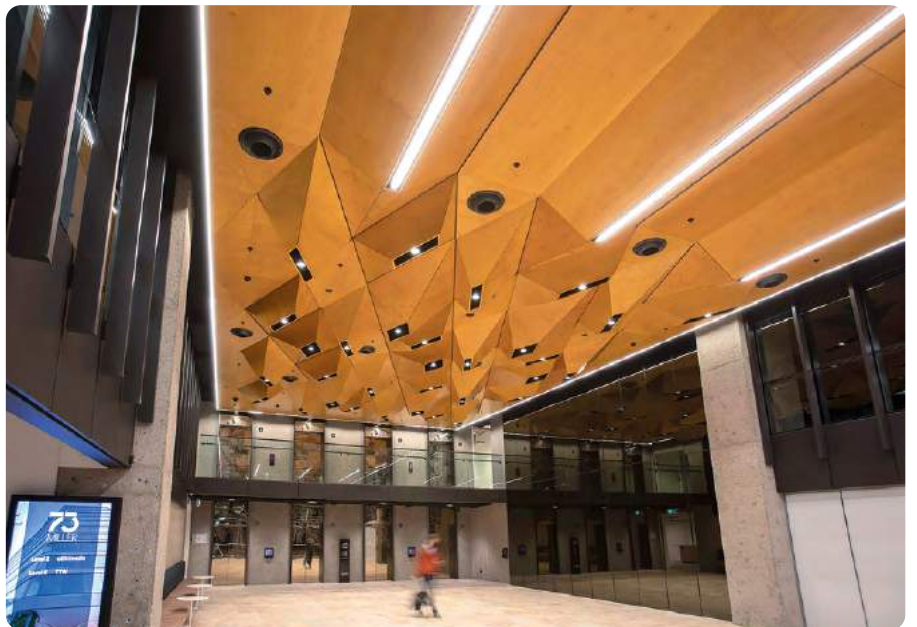

Matric AX IP54 | System 40 mm Surface



DE LED-Anbauleuchte für Wand- oder Deckenmontage. Rein direktstrahlend. Lichtkanal aus Aluminiumprofil mit 40mm Profildbreite. Oberfläche natur-eloxiert oder weiß, graphit, schwarz, champagner oder kupferfarben lackiert. Weitere Oberflächenoptionen siehe Lightnet-Surface-Collection oder RAL nach Wahl. Satinierter Opaldiffusor für Allgemeinbeleuchtung mit max. Transmissionsgrad und homogener Lichtpunktauflösung. Konverter in Leuchtengehäuse integriert, wahlweise einfach schaltbar oder stufenlos dimmbar (DALI, Touch-Dim). Farbtemperatur 2200K, 2700K, 3000K, 3500K, 4000K, 6500K oder Tunable White (2700-6500K). Binning initial \leq MacAdam 3. Farbwiedergabe CRI $>$ 80, CRI $>$ 90 oder Full Spectrum. Schutzart IP54.

EN LED surface-mounted luminaire for walls or ceilings. Direct only light distribution. Light channel made of 40mm wide aluminium profile. Surface natural anodised or white, graphite, black, champagne or copper coated. Further surface options see Lightnet-Surface-Collection or RAL of your choice. Satin opal diffuser for general lighting with maximum transmittance and homogeneous lighting. Driver integrated into luminaire housing, optionally switchable or dimmable (DALI, Touch-Dim). Colour temperature 2200K, 2700K, 3000K, 3500K, 4000K, 6500K or Tunable White (2700-6500K). Binning \leq MacAdam 3. Colour rendering CRI $>$ 80, CRI $>$ 90 or Full Spectrum. Ingress protection IP54.

LAX OVL - 8 30 M-L890-IP54

Product Family	L: Matric
Type	AX: Direct only
Optical System	O: Opal Diffuser, F: Ambient
Surface Finish	W: Snow White, V: Ivory White, E: Silver Anodised, U: Urban Graphite, B: Jet Black, H: Anodic Champagne
Control Gear	E: On/Off, L: DALI, H: Touch-Dim, 6: DALI DT6 for TW [L1182-L2055], 8: DALI DT8 for TW [L890-L2055], C: Casambi [L890-L2055]
Colour Rendering	8: CRI>80, 9: CRI>90, F: Full Spectrum [except 2200K]
Colour Temperature	22: 2200K, 27: 2700K, 30: 3000K, 35: 3500K, 40: 4000K, 65: 6500K, TW: Tunable White 2700-6500K
Power	M: Medium Power
Size	Luminaire Length in mm: L600, L890, L1182, L1475, L1765, L2055
Protection	IP54

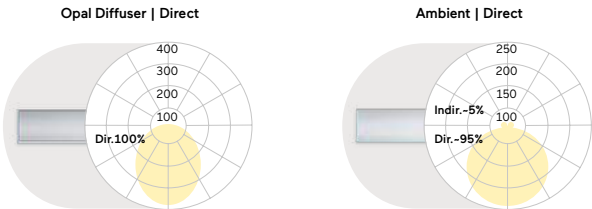

L mm	Lumen/Watt Medium Power	L mm	Lumen/Watt Medium Power
600	870lm/9W	600	1080lm/9W
890	1300lm/12W	890	1620lm/12W
1182	1730lm/15W	1182	2150lm/16W
1475	2160lm/19W	1475	2690lm/19W
1765	2600lm/22W	1765	3230lm/22W
2055	3030lm/28W	2055	3770lm/28W

Lumen Values: Luminaire luminous flux at 4000K/CRI>80. Other configurations on request.

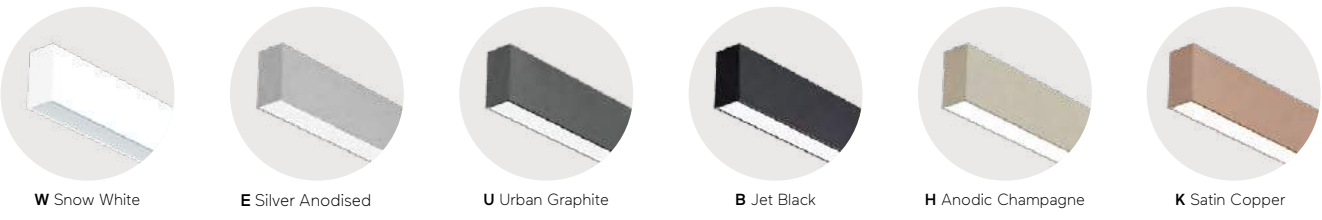
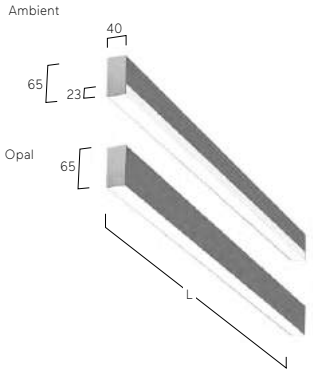

Matric A3 IP54 | System 55 mm Surface



DE LED-Anbauleuchte für Wand- oder Deckenmontage. Rein direktstrahlend. Lichtkanal aus Aluminiumprofil mit 40mm Profilbreite. Oberfläche natur-eloxiert oder weiß, graphit, schwarz, champagner oder kupferfarben lackiert. Weitere Oberflächenoptionen siehe Lightnet-Surface-Collection oder RAL nach Wahl. Satinierter Opaldiffusor für Allgemeinbeleuchtung mit max. Transmissionsgrad und homogener Lichtpunktauflösung. Konverter in Leuchtengehäuse integriert, wahlweise einfach schaltbar oder stufenlos dimmbar (DALI, Touch-Dim). Farbtemperatur 2200K, 2700K, 3000K, 3500K, 4000K, 6500K oder Tunable White (2700-6500K). Binning initial \leq MacAdam 3. Farbwiedergabe CRI $>$ 80, CRI $>$ 90 oder Full Spectrum. Schutzart IP54.

EN LED surface-mounted luminaire for walls or ceilings. Direct only light distribution. Light channel made of 55mm wide aluminium profile. Surface natural anodised or white, graphite, black, champagne or copper coated. Further surface options see Lightnet-Surface-Collection or RAL of your choice. Satin opal diffuser for general lighting with maximum transmittance and homogeneous lighting. Driver integrated into luminaire housing, optionally switchable or dimmable (DALI, Touch-Dim). Colour temperature 2200K, 2700K, 3000K, 3500K, 4000K, 6500K or Tunable White (2700-6500K). Binning \leq MacAdam 3. Colour rendering CRI $>$ 80, CRI $>$ 90 or Full Spectrum. Ingress protection IP54.

LA3 O V L - 8 30 M-L890-IP54

Product Family	L: Matric
Type	A3: Direct only
Optical System	O: Opal Diffuser, D: Opal Diffuser (Polycarbonate)**
Surface Finish	W: Snow White, V: Ivory White, E: Silver Anodised, U: Urban Graphite, B: Jet Black, H: Anodic Champagne
Control Gear	E: On/Off, L: DALI, H: Touch-Dim, 6: DALI DT6 for TW, 8: DALI DT8 for TW, C: Casambi [L890-L2055]
Colour Rendering	8: CRI>80, 9: CRI>90, F: Full Spectrum [except 2200K]
Colour Temperature	22: 2200K, 27: 2700K, 30: 3000K, 35: 3500K, 40: 4000K, 65: 6500K, TW: Tunable White 2700-6500K [L1182-L2055]
Power	M: Medium Power
Size	Luminaire Length in mm: L600, L890, L1182, L1475, L1765, L2055
Protection	IP54

**Opal Diffuser made of sustainable TruCircle Polycarbonate / Fire Rated - Glow wire flammability Index 950°C EN60695-2-12 / Tp(a). Luminous flux reduction of 10%



Opal Diffuser | Direct

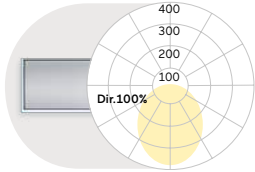

L mm	Lumen/Watt Medium Power
600	1210lm/12W
890	1820lm/16W
1182	2430lm/21W
1475	3030lm/26W
1765	3640lm/30W
2055	4250lm/38W

Lumen Values: Luminaire luminous flux at 4000K/CRI>80. Other configurations on request.

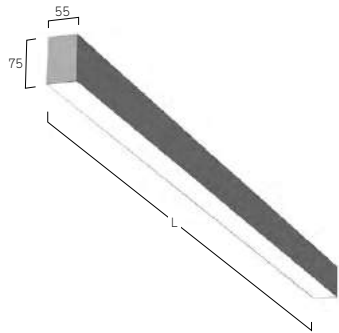

W Snow White



E Silver Anodised

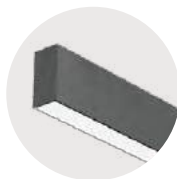

U Urban Graphite



B Jet Black



H Anodic Champagne



K Satin Copper

Matric FX IP54 | System 40 mm Recessed Frame



DE LED-Einbauleuchte für Montage in gesägten Deckenöffnungen. Rein direktstrahlend. Lichtkanal mit umlaufendem Rahmen aus Aluminiumprofil. Optikbreite 40mm. Oberfläche natureloxiert oder weiß, graphit, schwarz, champagner oder kupferfarben lackiert. Weitere Oberflächenoptionen siehe Lightnet-Surface-Collection oder RAL nach Wahl. Satinierter Opaldiffusor für Allgemeinbeleuchtung mit max. Transmissionsgrad und homogener Lichtpunktauflösung. Konverter in Leuchtengehäuse integriert, wahlweise einfach schaltbar oder stufenlos dimmbar (DALI, Touch-Dim). Farbtemperatur 2200K, 2700K, 3000K, 3500K, 4000K, 6500K oder Tunable White (2700-6500K). Binning initial \leq MacAdam 3. Farbwiedergabe CRI>80, CRI>90 oder Full Spectrum. Befestigungsset inklusive. Schutzart IP54.

EN Recessed mounted LED luminaire for installation in ceiling cut-outs openings. Direct only light distribution. Light channel with surrounding frame made of aluminium profile. Optic width 40mm. Surface natural anodised or white, graphite, black, champagne or copper coated. Further surface options see Lightnet-Surface-Collection or RAL of your choice. Satin opal diffuser for general lighting with maximum transmittance and homogeneous lighting. Driver integrated into luminaire housing, optionally switchable or dimmable (DALI, Touch-Dim). Colour temperature 2200K, 2700K, 3000K, 3500K, 4000K, 6500K or Tunable White (2700-6500K). Binning \leq MacAdam 3. Colour rendering CRI>80, CRI>90 or Full Spectrum. Mounting brackets included. Ingress protection IP54.

L FXO WL-8 30 M-L900-IP54

Product Family **L**: Matric

Type **FX**: Direct only

Optical System **O**: Opal Diffuser

Surface Finish **W**: Snow White, **V**: Ivory White, **E**: Silver Anodised, **U**: Urban Graphite, **B**: Jet Black, **H**: Anodic Champagne

Control Gear **E**: On/Off, **L**: DALI, **H**: Touch-Dim, **6**: DALI DT6 for TW, **8**: DALI DT8 for TW, **C**: Casambi [L900-L2065]

Colour Rendering **8**: CRI>80, **9**: CRI>90, **F**: Full Spectrum [except 2200K]

Colour Temperature **22**: 2200K, **27**: 2700K, **30**: 3000K, **35**: 3500K, **40**: 4000K, **65**: 6500K, **TW**: Tunable White 2700-6500K [L1192-L2065]

Power **M**: Medium Power

Size Luminaire Length in mm: **L610, L900, L1192, L1485, L1775, L2065**

Protection **IP54**



Opal Diffuser | Direct

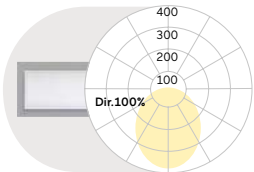

L mm	Lumen/Watt Medium Power
610	870lm/9W
900	1300lm/12W
1192	1730lm/15W
1485	2160lm/19W
1775	2600lm/22W
2065	3030lm/28W

Lumen Values: Luminarie luminous flux at 4000K/CRI>80. Other configurations on request.

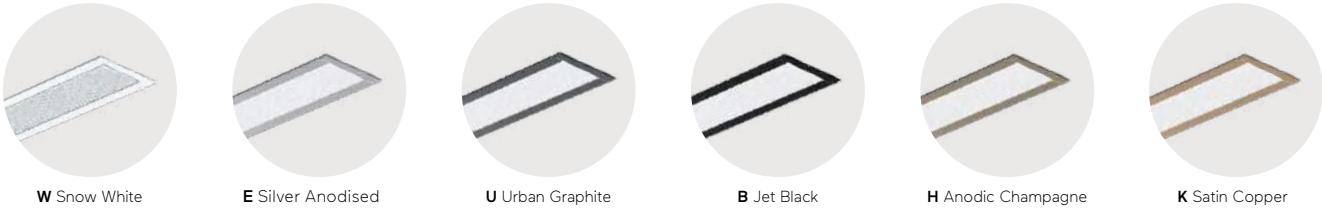
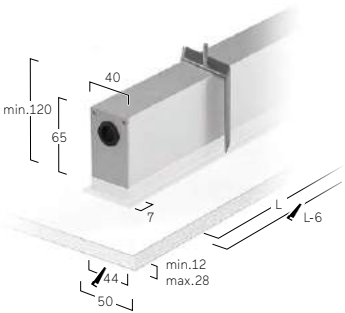

Matric F3 IP54 | System 55 mm Recessed Frame



DE LED-Einbauleuchte für Montage in gesägten Deckenöffnungen. Rein direktstrahlend. Lichtkanal mit umlaufendem Rahmen aus Aluminiumprofil. Optikbreite 55mm. Oberfläche natureloxiert oder weiß, graphit, schwarz, champagner oder kupferfarben lackiert. Weitere Oberflächenoptionen siehe Lightnet-Surface-Collection oder RAL nach Wahl. Satinierter Opaldiffusor für Allgemeinbeleuchtung mit max. Transmissionsgrad und homogener Lichtpunktauflösung. Konverter in Leuchtgehäuse integriert, wahlweise einfach schaltbar oder stufenlos dimmbar (DALI, Touch-Dim, Casambi). Farbtemperatur 2200K, 2700K, 3000K, 3500K, 4000K, 6500K oder Tunable White (2700-6500K). Binning initial \leq MacAdam 3. Farbwiedergabe CRI>80, CRI>90 oder Full Spectrum. Befestigungsset inklusive. Schutzart IP54.

EN Recessed mounted LED luminaire for installation in ceiling cut-outs openings. Direct only light distribution. Light channel with surrounding frame made of aluminium profile. Optic width 55mm. Surface natural anodised or white, graphite, black, champagne or copper coated. Further surface options see Lightnet-Surface-Collection or RAL of your choice. Satin opal diffuser for general lighting with maximum transmittance and homogeneous lighting. Driver integrated into luminaire housing, optionally switchable or dimmable (DALI, Touch-Dim, Casambi). Colour temperature 2200K, 2700K, 3000K, 3500K, 4000K, 6500K or Tunable White (2700-6500K). Binning \leq MacAdam 3. Colour rendering CRI>80, CRI>90 or Full Spectrum. Mounting brackets included. Ingress protection IP54.

L F30 WL-8 30 M-L905-IP54

Product Family	L: Matric
Type	F3: Direct only
Optical System	O: Opal Diffuser, D: Opal Diffuser (Polycarbonate)**
Surface Finish	W: Snow White, V: Ivory White, E: Silver Anodised, U: Urban Graphite, B: Jet Black, H: Anodic Champagne
Control Gear	E: On/Off, L: DALI, H: Touch-Dim, 6: DALI DT6 for TW [L1198-L2075], 8: DALI DT8 for TW [L905-L2075], C: Casambi [L905-L2075]
Colour Rendering	8: CRI>80, 9: CRI>90, F: Full Spectrum [except 2200K]
Colour Temperature	22: 2200K, 27: 2700K, 30: 3000K, 35: 3500K, 40: 4000K, 65: 6500K, TW: Tunable White 2700-6500K
Power	M: Medium Power
Size	Luminaire Length in mm: L615, L905, L1198, L1490, L1780, L2075
Protection	IP54

**Opal Diffuser made of sustainable TruCircle Polycarbonate / Fire Rated - Glow wire flammability Index 950°C EN60695-2-12 / Tp(a). Luminous flux reduction of 10%



Opal Diffuser | Direct

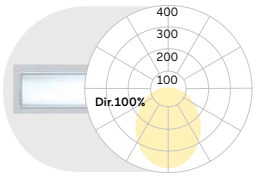

L mm	Lumen/Watt Medium Power
615	1210lm/12W
905	1820lm/16W
1198	2430lm/21W
1490	3030lm/26W
1780	3640lm/30W
2075	4250lm/38W

Lumen Values: Luminaire luminous flux at 4000K/CRI>80. Other configurations on request.

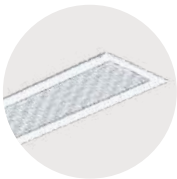
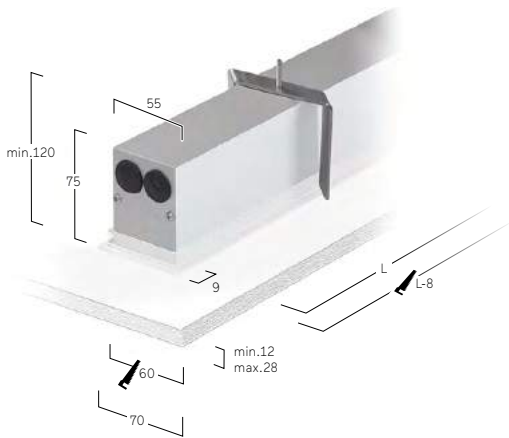

W Snow White

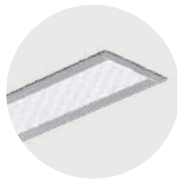

E Silver Anodised

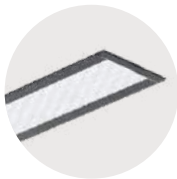

U Urban Graphite



B Jet Black

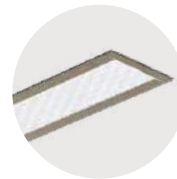

H Anodic Champagne



K Satin Copper

Appendix

Surface Design



W Snow White (RAL 9003)



V Ivory White (RAL 9010)



E Silver Anodised



Light Grey



S Radiant Silver (RAL9006)



H Anodic Champagne



U Urban Graphite

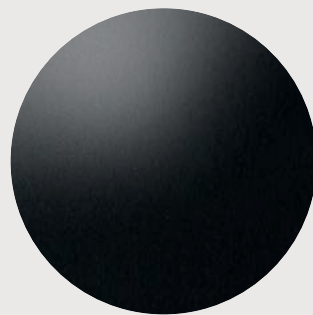

B Jet Black (RAL 9005)



Burnished Steel

DE Die Lightnet Surface Collection besteht aus 18 ausgewählten hochwertigen und architekturelevanten Oberflächendesigns. Hierbei werden unterschiedliche handwerkliche und industrielle Techniken verwendet, die weit über eine bloße Farbgebung nach RAL hinausreichen. So satinieren wir z.B. Oberflächen und verwenden liquide Metalle und Beton. Sollte die jeweilige Wunsch-Oberfläche nicht im Konfigurations-Tableau auf der Produktseite aufgeführt sein, kann diese gesondert angefragt werden. Darüber hinaus bieten wir unsere gesamte Leuchtenkollektion auch im Sonderfarbton Ihrer Wahl nach RAL/NCS an.

EN The Lightnet Surface Collection consists of eighteen high-quality and architecturally relevant surface designs. We use a variety of craftsmanship and industrial techniques that go far beyond mere RAL colouring. For example, we satin finish surfaces and use liquid metals and concrete. If the respective desired surface is not listed in the configuration table on the product page, it can be requested separately. In addition, we also offer our entire luminaire collection in the RAL/NCS colour of your choice.



A Satin Silver



Satin Platinum



G Satin Gold

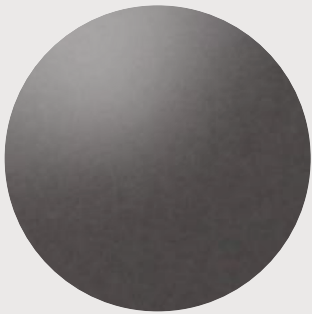

Iron Grey



K Satin Copper



Medium Brass



Ash Concrete



Stalwart Rust



Architectural Bronze

Colour Temperature



DE Nahezu unser gesamtes Sortiment ist in den Lichtfarben 2200K, 2700K, 3000K, 3500K, 4000K und 6500K erhältlich. Auf Anfrage sind auch weitere Sonderlichtfarben möglich. Für ca. 80% unserer Produkte haben wir Tuneable-White-Lösungen entwickelt. Hierbei kann die Lichtfarbe von 2700K bis 6500K stufenlos eingestellt werden. In Verbindung mit HCL-Control kann die Lichtfarbe und Lichtintensität im Tagesablauf dynamisch verändert werden und so Human Centric Konzepte umgesetzt werden. Bitte beachten Sie, dass sich alle Lichtstromangaben in diesem Katalog auf eine Referenzmessung mit Farbtemperatur 4000K beziehen. Korrekturfaktoren für andere Lichtfarben stellen wir für das jeweilige Produkt auf Anfrage zur Verfügung.

EN Almost our entire range is available in the following colour temperatures 2200K, 2700K, 3000K, 3500K, 4000K and 6500K. Other special light colours are also available on request. We have developed Tuneable White solutions for approx. 80% of our products. Here, the light colour can be continuously adjusted from 2700K to 6500K. In combination with HCL-Control, the light colour and light intensity can be changed dynamically during the course of the day and thus Human Centric Lighting concepts can be implemented. Please note that all luminous flux specifications in this catalogue refer to a reference measurement with colour temperature 4000K. Correction factors for other light colours are available for the respective product on request.

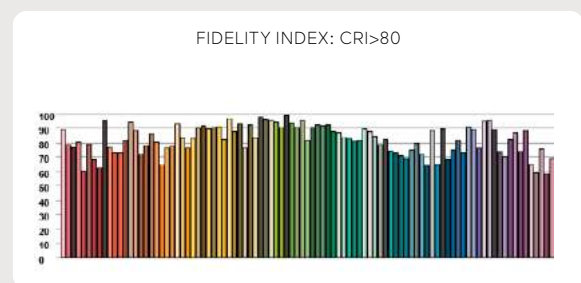
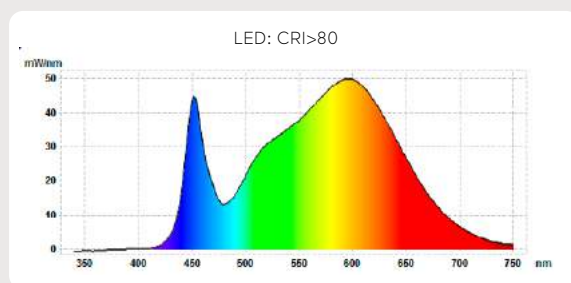
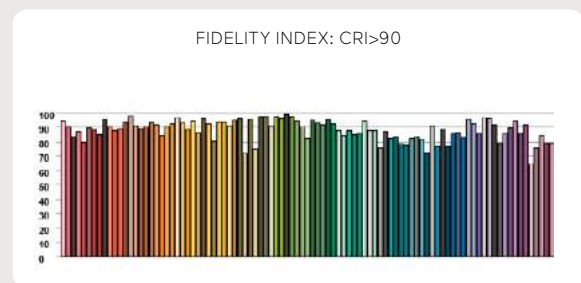
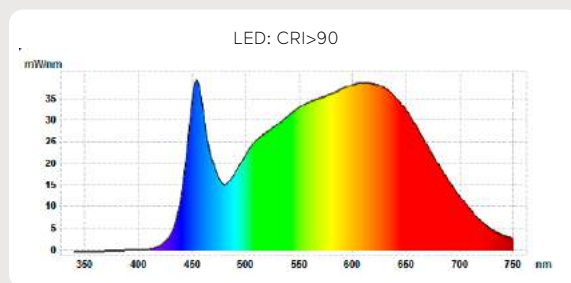
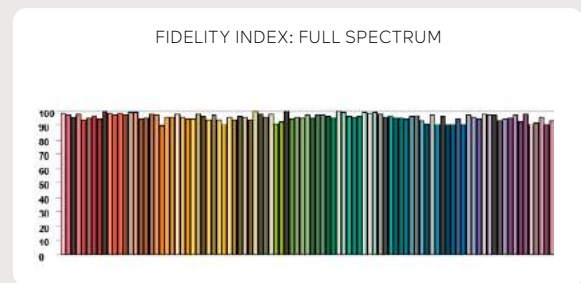
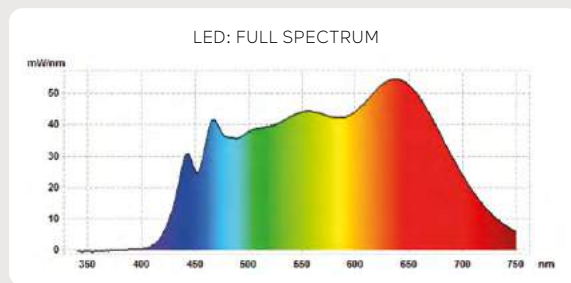

DE Produktübergreifend bieten wir nahezu unser gesamte Leuchtenkollektion in den Farbwiedergabestufen CRI>80, CRI>90 und Full Spectrum an (Serie Midpin und Midpoint nur CRI>90). Die Farbwiedergabestufe Full Spectrum bildet dabei das Lichtspektrum des Sonnenlichts nach. Auf diese Weise hat sie positiven Einfluss auf die Gesundheit des Menschen und garantiert lebendige Farben und starke Kontraste. Auf Anfrage stellen wir für eine genauere Einschätzung der Farbwiedereigenschaften je Produkt den Fidelity-Index gemäß TM-30-15 zur Verfügung. Bitte beachten Sie, dass sich alle Lichtstromangaben in diesem Katalog auf eine Referenzmessung mit Farbwiedergabe CRI>80 (Midpin&Midpoint CRI>90) beziehen. Korrekturfaktoren für andere Farbwiedergabestufen stellen wir für das jeweilige Produkt auf Anfrage zur Verfügung.

EN We offer almost our entire luminaire collection with CRI>80, CRI>90 and Full Spectrum colour rendering (Midpin and Midpoint series only CRI>90). Full Spectrum reproduces the light spectrum of sunlight. In this way, it has a positive influence on human health and guarantees vivid colours and strong contrasts. For a more precise assessment of the colour rendering properties of each product, we can provide the Fidelity Index according to TM-30-15 on request. Please note that all luminous flux data in this catalogue refers to a reference measurement with colour rendering CRI>80 (Midpin&Midpoint CRI>90). Correction factors for other colour rendering levels are available for the respective product on request.

Multisensor

General product description (short version)

Option 1: Automatic mode

Luminaire turns itself on/off, automatic daylight and motion control

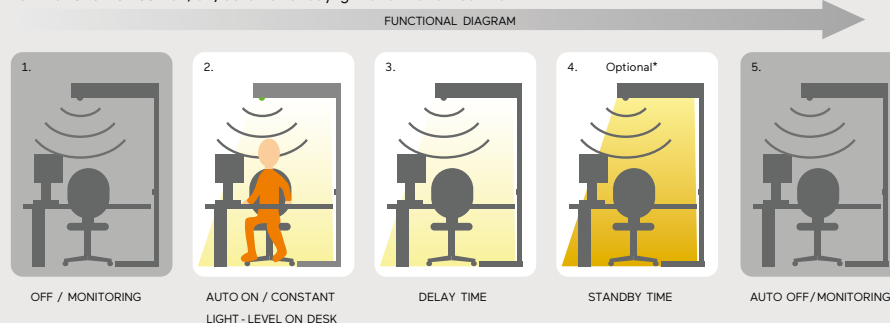

Option 2: Semi-Automatic mode (optional)

Luminaire always switched on /off manually, automatic daylight and motion control

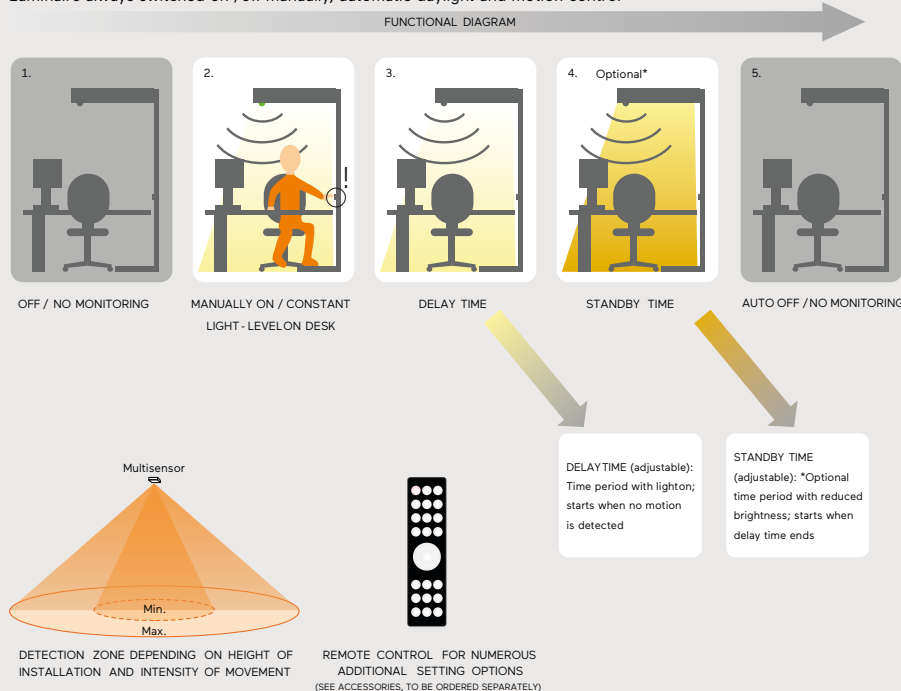

DE Multisensor bestehend aus einem PIR-Bewegungssensor (Passiv-Infrarot) und einem Lichtfühler. Sämtliche Sensorkomponenten in Leuchtenkorpus integriert. Das System ist konzipiert für individuell gesteuerte Leuchten, die nicht an ein Gebäudeleitsystem angeschlossen sind. Im vollautomatischen Modus schaltet der Multisensor die Leuchte bei Präsenzerkennung an, reguliert die Lichtintensität gemäß des Umgebungslichts und schaltet die Leuchte bei fehlender Präsenzerfassung mit einstellbarer Zeitverzögerung aus. Das System kann zusätzlich per Drucktaster (drahtgebunden; sowohl in externer Ausführung als auch direkt in Leuchte integriert), per Funktaster oder über eine Smartphone-/ Tablet-Anwendung manuell angesteuert werden. Typische konfigurierbare Zusatzfunktionen: Halbautomatischer Betrieb (manuelles Einschalten der Leuchte, anschließende automatische Regulierung der Lichtintensität und Abschaltung), zweistufige Abschaltung bei fehlender Präsenz sowie verschiedene Gruppenfunktionen (drahtlose Verbindung mit anderen Leuchten). Vielzahl weiterer Sensorfunktionen- und Programmierungen über eine per Zubehörprogramm bestellbare Fernbedienung oder per Smartphone-/ Tablet-Anwendung. Weitere technische Details siehe Bedienungsanleitung oder auf Anfrage.

EN Our Multi-sensors consist of a PIR motion sensor (passive infrared) and a light sensor. All sensor components are integrated in the luminaire body. The system is designed for individually controlled luminaires that are not connected to a building management system. In fully automatic mode, the multi-sensor switches the luminaire on when presence is detected, regulates the light intensity according to the ambient light and switches the luminaire off with an adjustable time delay if presence is not detected. The system can also be controlled manually via push-button (wired; both in external version and directly integrated in luminaire), via wireless push-button or via smartphone/tablet application. Typical configurable additional functions: Semi-automatic operation (manual switch-on of luminaire, subsequent automatic regulation of light intensity and switch-off), two-stage switch-off in the absence of presence and various group functions (wireless connection with other luminaires). Numerous other sensor functions and programming via a remote control that can be ordered from the accessories range or via smartphone/tablet application. For further technical details see operating instructions or on request.

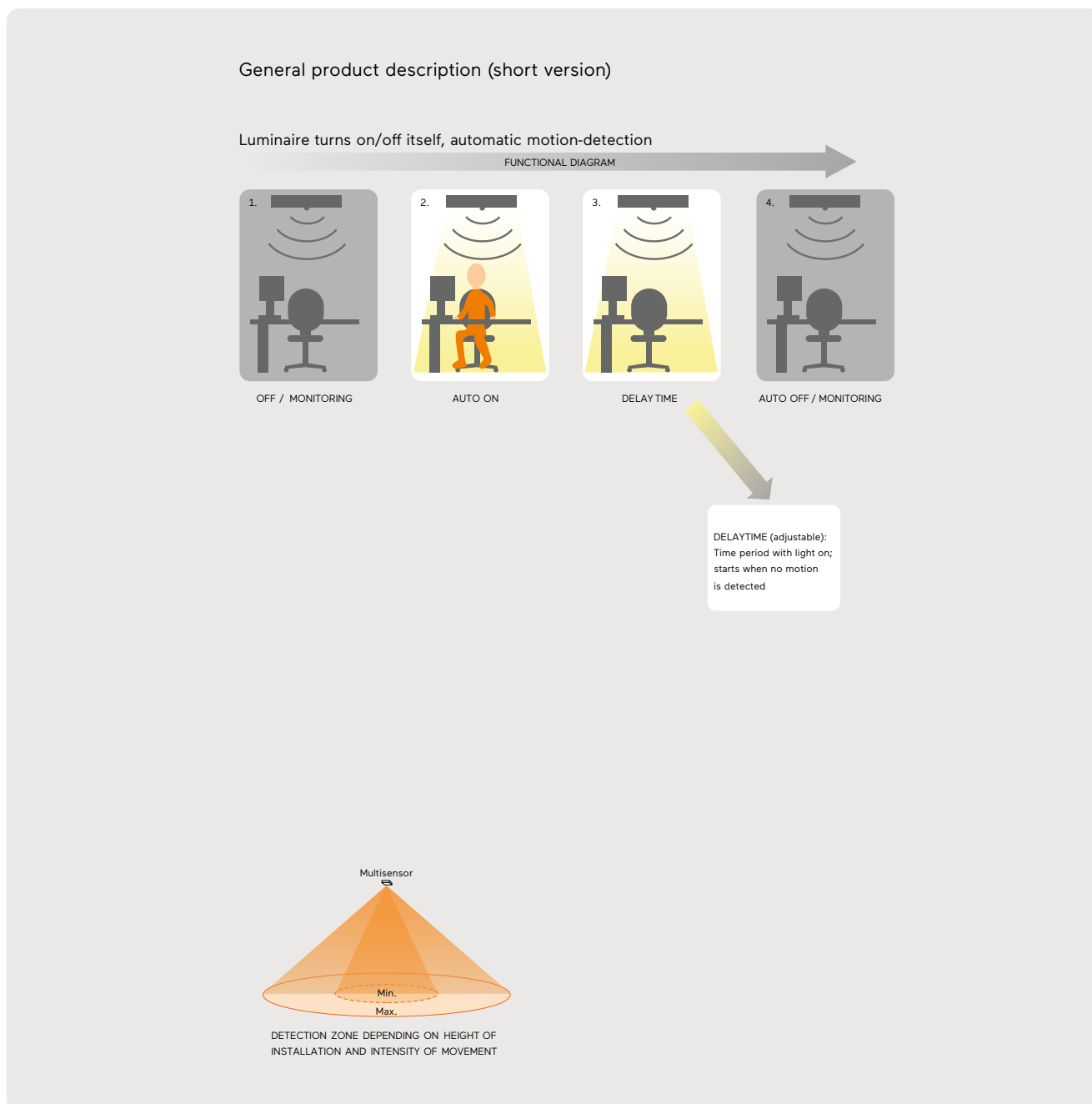

DE Radar Sensor bestehend aus einem Bewegungssensor in Hochfrequenz-Technologie im Mikrowellenfrequenzbereich und einem Steuergerät. Sämtliche Sensorkomponenten in Leuchtenkorpus integriert. Das System ist konzipiert für individuell gesteuerte Leuchten und Master-/Slave-Kombinationen, die nicht an ein Gebäudeleitsystem angeschlossen sind. Die Hauptaufgabe des Radar-Sensors besteht darin, die Leuchte bei Präsenzerkennung einzuschalten und bei fehlender Bewegungserkennung mit einstellbarer Zeitverzögerung auszuschalten. Weiter besteht die Möglichkeit, einen Schwellenwert für die umgebende Lichtintensität zu definieren, bei dessen Überschreitung der Sensor die Leuchte nicht mehr einschaltet. Die Konfiguration des Sensors erfolgt über DIP-SWITCH oder Drehknöpfe am Steuergerät. Weitere technische Details siehe Bedienungsanleitung oder auf Anfrage.

EN Radar sensor consisting of a motion sensor in high-frequency technology in the microwave frequency range and a control unit. All sensor components integrated in luminaire body. The system is designed for individually controlled luminaires and master/slave combinations that are not connected to a building management system. The main task of the radar sensor is to switch on the luminaire when presence is detected and to switch it off with an adjustable time delay when motion is not detected. Furthermore, it is possible to define a threshold value for the ambient light intensity, above which the sensor will no longer switch on the luminaire. The sensor is configured via DIP-SWITCH or rotary knobs on the control unit. For further technical details, see the operating instructions or contact us.

Swarm Control

General product description (short version)

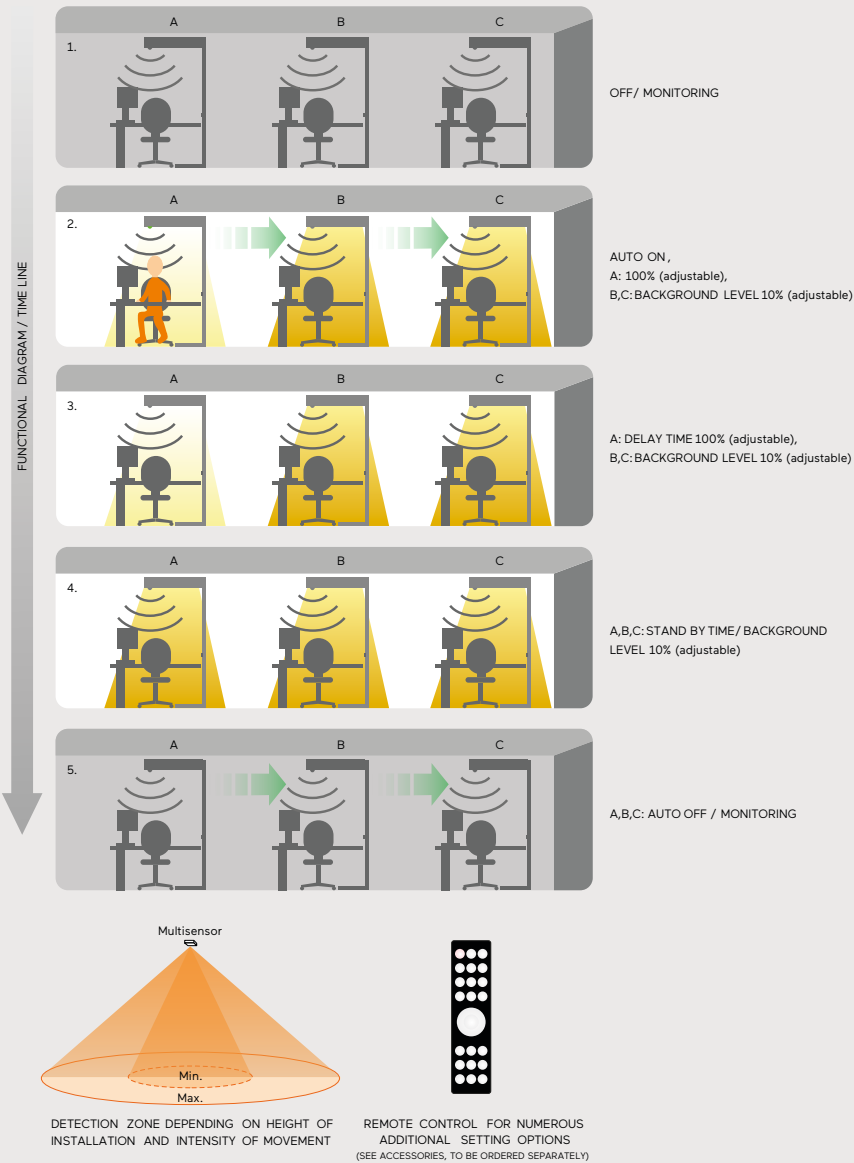

DE Swarm Control bestehend aus einem PIR-Bewegungssensor (Passiv-Infrarot) und einem Lichtfühler. Sämtliche Sensorkomponenten in Leuchtenkörper integriert. Das System ist konzipiert für individuell gesteuerte Leuchten, die nicht an ein Gebäudeleitsystem angeschlossen sind. Die Hauptanwendung von Swarm-Control findet sich in Open-Office-Büros. Ziel ist es, einen abrupten Übergang von hell zu dunkel aufgrund unbesetzter Arbeitsbereiche zu vermeiden und das Wohlbefinden über sanft ausgeleuchtete Hintergrundbereiche zu fördern. Die Präsenz erfassende Leuchte arbeitet im vollautomatischen Modus, d.h. der Multisensor schaltet die Leuchte an, reguliert die Lichtintensität gemäß des Umgebungslichts und schaltet die Leuchte bei fehlender Präsenzerfassung mit einstellbarer Zeitverzögerung aus. Gleichzeitig schaltet der Sensor die Leuchten seines Schwarms hinzu, eine Gruppe festgelegter Leuchten. Diese Leuchten arbeiten in zuvor definierter, reduzierter Lichtintensität und schalten zeitverzögert bei fehlender Präsenzerkennung des Schwarms ab. Die Kommunikation innerhalb eines Schwarms erfolgt drahtlos. Je nach Ausführung wird das Swarm-Control System über eine Smartphone-/Tablet-Anwendung oder mittels einer per Zubehörprogramm bestellbaren Fernbedienung konfiguriert. Weitere technische Details siehe Bedienungsanleitung oder auf Anfrage.

EN Swarm Control consisting of a PIR motion sensor (passive infrared) and a light sensor. All sensor components are integrated in the luminaire body. The system is designed for individually controlled luminaires that are not connected to a building management system. The main application of Swarm-Control is in open-office environments. The aim is to avoid an abrupt transition from light to dark due to unoccupied work areas and to promote well-being via softly illuminated background areas. The presence-detecting luminaire operates in fully automatic mode, i.e. the multi-sensor switches the luminaire on, regulates the light intensity according to the ambient light and switches the luminaire off with an adjustable time delay if presence is not detected. At the same time, the sensor switches on the luminaires of its swarm, a group of defined luminaires. These luminaires operate at a previously defined, reduced light intensity and switch off with a time delay if the swarm fails to detect presence. Communication within a swarm is wireless. Depending on the version, the Swarm-Control system is configured via a smartphone/tablet application or by means of a remote control that can be ordered from the range of accessories. For further technical details, please see the operating instructions or contact us.

General product description (short version)

Luminaire turns itself ON/OFF, automatic daylight and motion control

FUNCTIONAL DIAGRAM

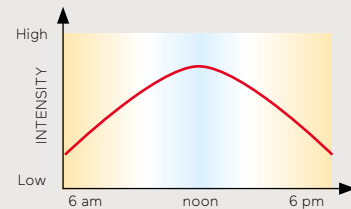
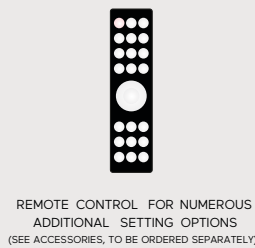
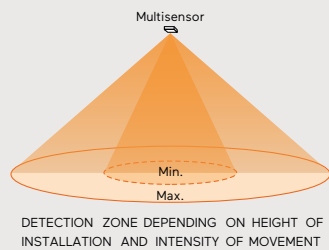
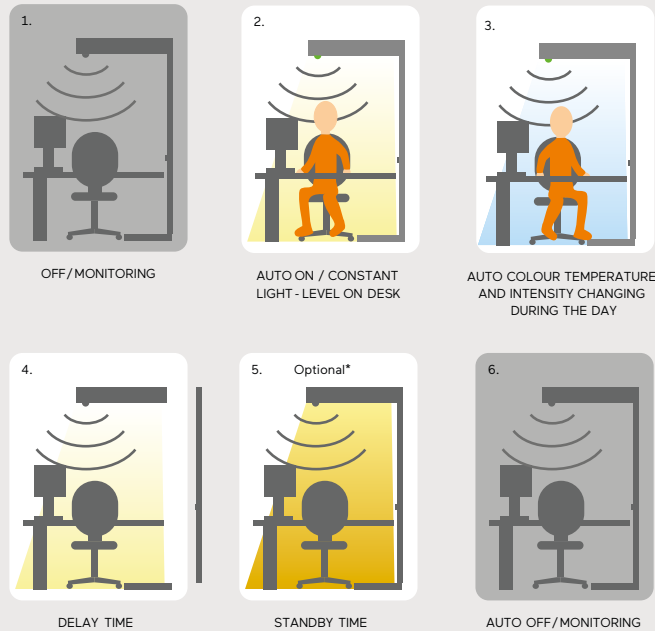

DE HCL-Control (Human-Centric-Control) für Tuneable White Leuchten bestehend aus einem PIR-Bewegungssensor (Passiv Infrarot) und einem Lichtsensor. Sämtliche Sensorkomponenten in Leuchtenkorpus integriert. Das System ist konzipiert für individuell gesteuerten Leuchten, die nicht an ein Gebäudeleitsystem angeschlossen sind. Ziel ist es, auch in Situationen und/oder Phasen geringer Tageslichtversorgung dem inneren Rhythmus einen Tageslicht-Abgleich zu ermöglichen und die biologischen Prozesse zu steuern. So, wie sich das Licht im Laufe des Tages ändert, so passen sich Leuchten mit HCL-Control gemäß eines zuvor programmierbaren Algorithmus in Lichtfarbe und Beleuchtungsstärke dynamisch dem Tageslichtverlauf an. Zusätzlich schaltet der Multisensor die Leuchte im vollautomatischen Modus bei Präsenzerkennung an, reguliert die Lichtintensität gemäß des Umgebungslichts und schaltet die Leuchte bei fehlender Präsenzerfassung mit einstellbarer Zeitverzögerung aus. Das System kann per Drucktaster (drahtgebunden; sowohl in externer Ausführung als auch direkt in Leuchte integriert), per Funktaster oder über eine Smartphone-/ Tablet-Anwendung manuell angesteuert werden. HCL-Control wird über eine Smartphone-/Tablet-Anwendung konfiguriert. Weitere technische Details siehe Bedienungsanleitung oder auf Anfrage.

EN HCL Control (Human-Centric Lighting Control) for Tuneable White luminaires consisting of a PIR (Passive Infrared) motion sensor and a light sensor. All sensor components are integrated in the luminaire body. The system is designed for individually controlled luminaires that are not connected to a building management system. The aim is to provide daylight balance to the inner rhythm even in situations and/or phases of low daylight supply and to control biological processes. Just as light changes during the course of the day, luminaires with HCL-Control dynamically adapt to the course of daylight in terms of light colour and illuminance according to a previously programmable algorithm. In addition, the multi-rev iksensor switches the luminaire on in fully automatic mode when presence is detected, regulates the light intensity according to the ambient light and switches the luminaire off with an adjustable time delay when presence is not detected. The system can be controlled manually by push-button (wired; both in external version and directly integrated in luminaire), by wireless push-button or via a smartphone/tablet application. HCL-Control is configured via a smartphone/tablet application. For further technical details, see operating instructions or on request.

Emergency Light

General product description (short version)

Option 1: Built in battery pack

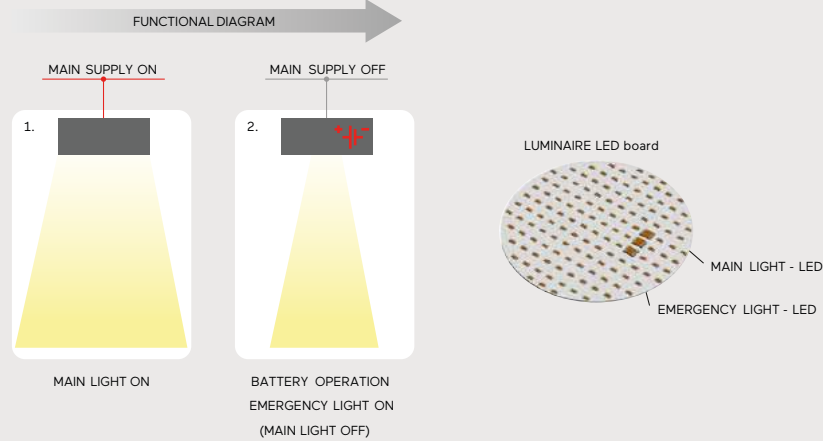

Option 2: External central battery

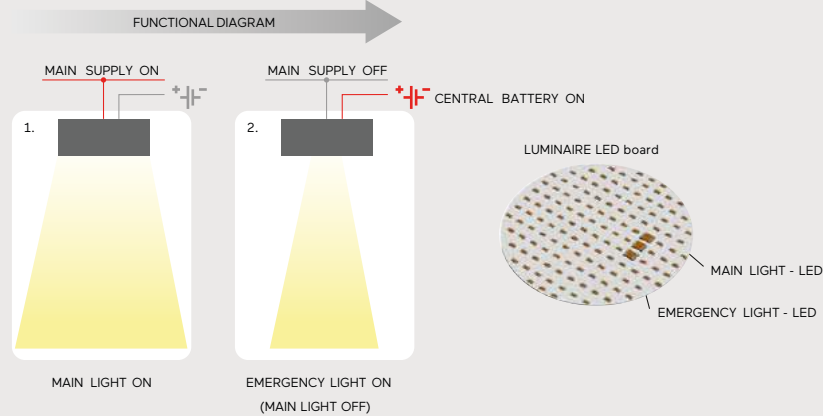

DE Notlichtmodul bestehend aus einem Steuermodul, einer 3h-Batterie und einer Notlichtquelle. Sämtliche Komponenten in Leuchtenkorpus integriert Die Notlichtquelle besteht aus zusätzlichen LED-Chips, die im Normalbetrieb nicht sichtbar sind (in einigen Fällen kann die Hauptlichtquelle ganz oder teilweise anstelle der zusätzlichen Notlichtquelle verwendet werden). Das Steuermodul überwacht den Zustand der Hauptstromversorgung und schaltet bei deren Ausfall die zusätzliche Notlichtquelle ein, die von der eingebauten Batterie gespeist wird. Wird die Hauptstromversorgung wieder eingeschaltet, schaltet das Modul die Notlichtquelle ab und beginnt mit der Wiederaufladung der Batterie. Die Überwachung des Batterieverbrauchs und der Effizienz der Lichtquelle erfolgt automatisch (Selbsttest). Die Kombination der Möglichkeiten der Selbsttestfunktion mit der Fernsteuerung über einen zentralen DALI-Controller ist möglich. Details siehe Bedienungsanleitung. Auf gesonderte Anfrage ist die Integration von Steuermodulen für eine zentrale Batterieversorgung möglich.

EN Emergency light module consisting of a control module, a 3h battery and an emergency light source. All components integrated in luminaire body The emergency light source consists of additional LED chips that are not visible during normal operation (in some cases, the main light source can be used completely or partially instead of the additional emergency light source). The control module monitors the status of the main power supply and, in the event of its failure, switches on the additional emergency light source, which is powered by the built-in battery. When the main power supply is switched on again, the module switches off the emergency light source and starts recharging the battery. Monitoring of battery consumption and light source efficiency is automatic (self-test). Combining the possibilities of the self-test function with remote control via a central DALI controller is possible. For details, see operating instructions. On separate request, the integration of control modules for a central battery supply is possible.

DE

Rechtliche Hinweise:

- Alle Angaben in diesem Katalog entsprechen dem Stand bei Drucklegung. Sie dienen ausschließlich Informationszwecken und sind unverbindlich
- Lightnet behält sich das Recht vor, jederzeit und ohne vorherige Ankündigung Änderungen in Abmessung, Konstruktion, Gewicht, Lichtstrom, Leistungsaufnahme und Lichtverteilung vorzunehmen
- Lightnet passt seine Produkte laufend den neusten technischen Entwicklungen an, dies gilt sowohl für LED-Chips, Betriebsgeräte, Materialität der Produkte und Optiken, Oberflächen, Abmessungen etc. Einhergehende Änderungen der Lichtverteilung, Lichtströme, Leistungsaufnahme, Blendwirkung bzw. UGR-Werte etc. gegenüber Katalogwerten sind im Zeitablauf unvermeidbar. Zur Sicherstellung einer aktuellen technischen und lichttechnischen Beurteilung ziehen Sie daher bitte grundsätzlich die auf Homepage www.lightnet.de zur Verfügung gestellten und laufend aktualisierten Datenblätter, lichttechnischen Dateien und sonstige erläuternde Informationen heran
- Gegenüber Abbildungen und/oder Fotos kann es beim Produkt zu Abweichungen kommen, für die keine Haftung übernommen wird
- Es erfolgt keine Haftung für Druckfehler. Die nachträgliche Korrektur offensichtlicher Irrtümer wird vorbehalten
- Alle Aufträge werden ausschließlich zu den Allgemeinen Geschäfts- und Lieferbedingungen der Lightnet GmbH in gültiger Fassung entgegengenommen. Diese können jederzeit unter www.lightnet.de eingesehen oder direkt bei Lightnet angefordert werden

Technische Hinweise:

- Alle Maßangaben werden in der Einheit Millimeter (mm) kommuniziert
- Alle Angaben zum Gewicht werden in der Einheit Kilogramm (kg) kommuniziert und unterliegen einer Toleranz von +/- 10%
- Alle Angaben zur Leistungsaufnahme werden in der Einheit Watt (W) kommuniziert und verstehen sich – soweit nicht explizit anders angegeben – inklusive integrierter Betriebsgeräte. Die kommunizierten Werte unterliegen initial einer Toleranz von +/- 10%
- Alle Angaben zur Farbtemperatur werden in der Einheit Kelvin (K) kommuniziert und unterliegen initial einer Toleranz von +/- 150K
- Alle Lichtstromangaben werden in der Einheit Lumen (lm) kommuniziert, unterliegen initial einer Toleranz von +/- 10% und bezeichnen die gesamte Lichtstromemission einer Leuchte
- Die angegebenen Lichtstromwerte beziehen sich auf eine Referenz-Messung mit Farbtemperatur ca. 4000K, Farbwiedergabeindex Ra>80, Leuchtgehäuse Farbe Weiß und Umgebungstemperatur 25°C. Auf Anfrage stellt Lightnet die sich ergebenden Korrekturfaktoren für alternative Farbtemperatur, Farbwiedergabe sowie Gehäusefarbe zur Verfügung
- Lightnet arbeitet mit unterschiedlichen Lichteinspeisungen und LED-Chips für die Kategorien a) Strahler, b) seitlich eingespeiste Leuchten sowie, c) hintergrundbeleuchtete Leuchten. Wahrnehmbare Unterschiede der Leuchtdichte und/oder der Farbtemperatur sind bei Kombination vorstehender Kategorien technologisch bedingt und unvermeidbar
- Alle ausgezeichneten UGR-Werte beziehen sich auf das sogenannte UGR-Tabellen-Verfahren (Referenzraum 4H/8H gemäß LiTG; Reflexionsgrade D/W/B: 0,7/0,5/0,2; Abstands-/ Höhenverhältnis: 0,25)

Allgemeine Hinweise:

Wir weisen auf die einschlägigen Normen (z.B. DIN EN 12464-1) einer ordnungsgemäßen Beleuchtung für die jeweilige Anwendung hin. Die Ermittlung praxisnaher lichttechnischer Werte (Beleuchtungsstärke, Blendungsbegrenzung, Gleichmäßigkeit etc.) setzt das Erstellen einer Lichtplanung (z.B. anhand Software Dialux, Relux) unter Berücksichtigung der tatsächlichen Gegebenheiten vor Ort (Reflexionsgrade, Positionierung Leuchten und Mobiliar etc.) voraus. Regelmäßig aktualisierte photometrische Dateien für die einzelnen Produkte stellt Lightnet unter www.lightnet.de zur Verfügung.

EN

Legal notes:

- All information in this catalogue is correct at the time of publication, is for information purposes only and does not constitute any obligation on our part
- Lightnet reserves the right to make changes in dimensions, construction, weight, luminous flux, power consumption and light distribution at any time and without prior notice
- Lightnet continuously adapts its products to the latest technical developments. This applies to LED chips, control gear, materiality of the products and optics, surfaces, product dimensions etc. Changes in light distribution, luminous flux, power consumption, glare or UGR values compared to catalogue values are unavoidable over time. To ensure that your technical and lighting assessment is up-to-date, please always refer to current data sheets, photometric files and other explanatory information made available on the homepage www.lightnet.de and updated on an ongoing basis
- Compared to illustrations and/or photos, there may be deviations in the product for which no liability is assumed
- We shall not be held liable for printing errors. The correction of obvious errors is reserved
- All orders will be processed in accordance to the current version of our General Terms of Business and our Terms of Delivery. These can be viewed at any time at www.lightnet.de or requested directly from Lightnet

Technical information:

- All dimensions are communicated in millimeters (mm)
- All weight information is communicated in kilograms (kg) and subject to a tolerance of +/- 10%
- All data on power consumption is communicated in watts (W) and – unless not stated otherwise – includes integrated control gear. All values are subject to a tolerance of max. +10% initial
- All information on the colour temperature are communicated in Kelvin (K) and are subject to a tolerance of +/- 150 K initial
- All data on luminous flux is communicated in lumen (lm), is subject to a tolerance of +/- 10% initial and indicates the delivered lumen output of a luminaire
- The communicated values refer to a reference measurement (colour temperature approx. 4000K, CRI > 80, colour of luminaire housing: white, environmental temperature: 25°C). Upon request, Lightnet will provide the resulting correction values if the colour temperature, colour rendering (CRI) or luminaire housing colour changes
- Due to technological aspects Lightnet has to use different LED chips for the categories a) spotlights, b) side-lighting LED luminaires and c) backlit LED luminaires. Perceptible differences in luminance and/or colour temperature are technologically determined and unavoidable when the above mentioned categories are mixed
- All UGR marked products refer to the so-called UGR table method (reference space 4H / 8H according to LiTG, reflectance C / W / G: 0.7 / 0.5 / 0.2, distance/height ratio: 0.25)

General information:

We refer to the relevant standards (for example DIN EN 12464-1) for proper lighting in the relevant application. The determination of photometric values (illuminance, glare limitation, uniformity, etc.) according to given situation assumes the creation of a lighting design (for example, software Dialux, Relux) taking into account the real conditions on site (Reflectance, positioning of lights and furniture etc.). Regularly updated and current photometric files for each product are available at www.lightnet.de.

Index

Basic

	Code	Page
Basic Déco A3/A4 Surface	BA3 BA4	346
Basic Déco C3 3-Phase Track	BC3	38
Basic Déco G3/P3 Suspended	BG3 BP3	188
Basic Déco L3 Recessed Frame	BL3	446
Basic Déco N3 Recessed Frameless	BN3	444
Basic Déco O3 Suspended	BO3	192
Basic Déco S3 Floor	BS3	82
Basic Déco S5 Floor	BS5	84
Basic Déco X3 Surface	BX3	348
Basic Déco XXL G4/P4 Suspended	BG4 BP4	190
Basic Déco Y3/X3 Wall	BY3 BX3	136
Basic Déco Z3 Surface	BZ3	350
Basic L7 Superflat Semi-Recessed	BL7	442
Basic Max A1 Surface	BA1	352
Basic Max A1 IP54 Surface	BA1	512
Basic Max G1/P1 Suspended	BG1 BP1	196
Basic Max M2 Recessed Frameless	BM2	450
Basic Max M4 Recessed Frame	BM4	452
Basic Max Y1/X1 Surface	BY1 BX1	354
Basic Neo A5 Surface	BA5	342
Basic Neo G5/P5 Suspended	BG5 BP5	184
Basic Neo S2 Floor	BS2	78
Basic Neo S4 Floor	BS4	80
Basic Neo W5 Wall	BW5	132
Basic Neo X5 Surface	BX5	344
Basic Neo Y5/X5 Wall	BY5 BX5	134
Basic Superflat G7/P7 Suspended	BG7 BP7	180
Basic Superflat X7/Y7 Wall	BX7 BY7	130
Basic Superflat Y7/X7 Surface	BY7 BX7	338
Basic Visio G9/P9 Suspended	BG9 BP9	198
Basic Visio L9 Semi-Recessed	BL9	454
Basic Visio Y9/X9 Surface	BY9 BX9	356
Basic Visio Y9/X9 Wall	BY9 BX9	138

Beam Me Up

Beam Me Up (Max) G1/P1 Suspended	MG1 MP1	206
Beam Me Up (Max) Y1/X1 Surface	MY1 MX1	362
Beam Me Up (Flat) G3/P3 Suspended	MG3 MP3	202
Beam Me Up (Flat) Y3/X3 Surface	MX3 MY3	358
Beam Me Up (Wallwasher) A4 Surface	MA4	364
Beam Me Up S1 Mini Floor	MS1	86
Beam Me Up S4 Floor	MS4	88
Beam Me Up S6 Floor	MS6	90
Beam Me Up T1 Mini Table Office	MT1	56
Beam Me Up T2 Mini Table Home	MT1	58

Caleo

Caleo Inverse AX System 40mm Surface	AAX	386
Caleo Inverse GX/PX System 40mm Susp.	AGX APX	274
Caleo Max M2 Recessed Frameless	AM2	476
Caleo Neo G4/P4 Suspended	AG4 AP4	276
Caleo Neo G6/P6 Suspended	AG6 AP6	280
Caleo Neo S2 Floor	AS2	96
Caleo Neo S4 Floor	AS4	98
Caleo Neo Y4/X4 Surface	AY4 AX4	388
Caleo Neo Y6/X6 Surface	AY6 AX6	390
Caleo Neo Y6/X6 Wall	AY6 AX6	144

Code Zero

	Code	Page
Code Zero G3/P3 Suspended	ZG3 ZP3	272

Cubic

Cubic Ambient A7 Surface	CA7	402
Cubic Ambient A7 Wall	CA7	154
Cubic Ambient G7/P7 Suspended	CG7 CP7	296
Cubic Déco A3 Surface	CA3	404
Cubic Déco A3 Wall	CA3	152
Cubic Déco G3/P3 Suspended	CG3 CP3	298
Cubic Déco L3 Recessed Frame	CL3	486
Cubic Evolution C4 3-Phase Track	CC4	44
Cubic Evolution F1 Floor	CF1	104
Cubic Evolution F2 Floor	CF2	106
Cubic Evolution F3 Floor	CF3	108
Cubic Evolution F5/F6 Floor	CF5 CF6	110
Cubic Evolution F7 Floor	CF7	112
Cubic Evolution F8 Floor	CF8	114
Cubic Evolution G4/P4 200mm Suspended	CG4 CP4	284
Cubic Evolution G5/P5 300mm Suspended	CG5 CP5	286
Cubic Evolution G6/P6 Square Suspended	CG6 CP6	288
Cubic Evolution System G4/P4 Suspended	CG4 CP4	290
Cubic Evolution T2/T3 Table	QTX	60
Cubic Evolution U4 Suspended	CU4	292
Cubic Evolution W4 Wall	CW4	148
Cubic Evolution Y4/X4 200mm Surface	CY4 AX4	392
Cubic Evolution Y5/X5 300mm Surface	CY5 AX5	394
Cubic Evolution Y6/X6 Square Surface	CY6 AX6	396
Cubic Evolution Y6/X6 Wall	CY6 CX6	150
Cubic M7 Ambient Recessed Frame	CM7	484
Cubic Max A2/X2 Surface	CA2 CX2	400
Cubic Max G2/P2 Suspended	CG2 CP2	294
Cubic Max M2 Recessed Frameless	CM2	480
Cubic Max M4 Recessed Frame	CM4	482
Cubic Neo A9 Surface	CA9	398

Grand Lucille

Grand Lucille S9 Floor	US9	70
--------------------------	-----	----

Liquid Line

Liquid Line A3 System 60mm Surface	QA3	380
Liquid Line AX System 40mm Surface	QAX	376
Liquid Line Compact A5 Surface	QA5	374
Liquid Line Compact C5 3-Phase Track	QC5	40
Liquid Line Compact F5 Recessed Frame	QF5	462
Liquid Line Compact G5/P5 Suspended	QG5 QP5	246
Liquid Line Compact W5 Wall	QW5	140
Liquid Line CX System 40mm 3-Phase Track	QCX	42
Liquid Line F3 System 60mm Recessed	QF3	472
Liquid Line G3/P3 System 60mm Suspended	QG3 QP3	264
Liquid Line GX/PX System 40mm Suspended	QGX QPX	248
Liquid Line QX/FX System 40mm Recessed	QQX QFX	464
Liquid Line SX System 40mm Floor One Head	QSX	92
Liquid Line SY System 40mm Floor Two Heads	QSY	94
Liquid Line TX System 40mm Table Asymmetric	QTX	64
Liquid Line TY System 40mm Table Symmetric	QTY	62
Liquid Line WX System 40mm Wall	QWX	142

Lucille

	Code	Page
Lucille S1 Floor	US1	74
Lucille T1 Table	UT1	54
Lucille W1 Wall	UW1	124

Matric

Matric A3 System 55mm Surface	LA3	420
Matric A3 IP54 System 55 mm Surface	LA3	518
Matric A5 System 81mm Surface	LA5	422
Matric A6 System 81mm Surface	LA6	424
Matric Ambient AX System 40mm Wall	LAX	158
Matric AX System 40mm Surface	LAX	418
Matric AX IP54 System 40 mm Surface	LAX	516
Matric AY System 40mm Surface	LAY	408
Matric Déco A9 Surface	LA9	406
Matric Déco C9 System 55mm 3-Phase Track	LC9	46
Matric Déco F9 Recessed Frame	LF9	490
Matric Déco G9/R9 Suspended	LG9 LR9	300
Matric Déco M9 Recessed Frameless	LM9	488
Matric DX System 40mm Wall	LDX	162
Matric F3 System 55mm Recessed Frame	LF3	504
Matric F3 IP54 System 55 mm Recessed Frame	LF3	522
Matric F5 System 81mm Recessed Frame	LF5	508
Matric FX System 40mm Recessed Frame	LFX	500
Matric FX IP54 System 40 mm Recessed Frame	LFX	520
Matric G3/R3 System 55mm Suspended	LG3 R3	312
Matric G6/R6 System 81mm Suspended	LG6 LR6	318
Matric GX/RX System 40mm Suspended	LGX RX	310
Matric JX System 40mm Wall	LJX	164
Matric M3 System 55mm Recessed Frameless	LM3	502
Matric M5 System 81mm Recessed Frameless	LM5	506
Matric MX System 40mm Recessed Frameless	LMX	498
Matric RY System 40mm Suspended	LRY	308
Matric Square Acoustic GX/RX System 40mm Susp.	LGX LRX	326
Matric Square GX/RX System 40mm Suspended	LGX LRX	322
Matric SX System 40mm Floor One Head	LSX	116
Matric SY System 40mm Floor Two Heads	LSX	118
Matric System G5 81mm Suspended	LG5	316
Matric System R4 55mm Suspended	LR4	314
Matric W4 System 55mm Wall	LW4	166
Matric W6 System 81mm Wall	LW6	168
Matric WX System 40mm Wall	LWX	160
Matric XY System 40mm Surface	LXY	410

Midpin

Midpin C2/C3 48V Track	DC2	30
Midpin G3 Single Suspended	DG3	174
Midpin M2 Recessed	DM2	430
Midpin W2 Wall	DW2	126

Midpoint

	Code	Page
Midpoint A6 Surface	PA6	336
Midpoint B7 Surface	PB7	334
Midpoint C6 3-Phase Track	PC6	34
Midpoint C7 3-Phase DALI Track	PC7	36
Midpoint E6 Semi-Recessed	PE6	436
Midpoint F7 Recessed	PF7	438
Midpoint M6 Recessed	PM6	440
Midpoint P7/P8 Suspended	PP7 PP8	176
Midpoint W7 Wall	PW7	128

Plank

Plank G4/P4 Suspended	JG4 JP4	330
Plank Y4/X4 Surface	JX4	428

Ringo Star

Ringo Star A1 System 100mm Surface	RA1	372
Ringo Star A3 System 60mm Surface	RA3	370
Ringo Star Acoustic G1/P1 System 100mm Suspended	RG1 RP1	228
Ringo Star Acoustic G3/P3 System 60mm Suspended	RG3 RP3	224
Ringo Star Acoustic GY/PY System 40mm Suspended	RGY RPY	214
Ringo Star AX System 40mm Surface	RAX	368
Ringo Star Chain G3/P3 Suspended	RG3 RP3	242
Ringo Star Chandelier G1/P1 Suspended	RG1 RP1	232
Ringo Star Cluster G3/P3 Suspended	RG3 RP3	240
Ringo Star Compact A5 Surface	RA5	366
Ringo Star Compact G5/P5 Suspended	RG5 RP5	208
Ringo Star F1 System 100mm Recessed Frame	RF1	462
Ringo Star F5 Compact Recessed Frame	RF5	456
Ringo Star FX System 40mm Recessed Frame	RFX	458
Ringo Star G1/P1 System 100mm Suspended	RG1 RP1	226
Ringo Star G3/P3 System 60mm Suspended	RG3 RP3	222
Ringo Star GX/PX System 40mm Suspended	RGX RPX	212
Ringo Star GY/PY System 40mm Suspended	RGY RPY	210
Ringo Star Oblong GX/PX Suspended	RGX RPX	244

Vision

Vision Gen. 4 A4/X4 Surface	VY4 VX4	424
Vision Gen. 4 G4/P4 Suspended	LG4 LP4	328

Lightnet Headquarters Germany

Lightnet GmbH
Zollstockgürtel 65
50969 Köln
+49 221 22 25 26-0
info@lightnet.de
lightnet.de

Lightnet Austria

Lightnet Austria GmbH
Döblinger Hauptstraße 42/9
1190 Wien
+43 1 39 50 793
info@lightnet.at
lightnet.at

Lightnet UK

Lightnet Group Limited
Unit 210-211 Canalot Studios,
222 Kensal Road
London W10 5BN
+44 20 81 46 69 81
info@lightnet-group.co.uk
lightnet-group.co.uk

Lightnet France

Lightnet SAS
5, allée d'Helsinki
67300 Schiltigheim
+33 3 69 24 69 13
info@lightnet.fr
lightnet.fr

Lightnet Poland

Lightnet Sp. z o.o.
ul. Sportowa 2
43-356 Kobiernice
+48 33 810 86 56
info@lightnet.pl
lightnet.pl

Lightnet USA

Lightnet USA Inc.
2937 SW 27th Ave Ste 305
Miami, FL 33133
+1 800 94 09 092
info@lightnet.us
lightnet.us

Lightnet Mexico

Lightnet Mexico S.C.
Francisco Ortega No 30-32
Col. Villa Coyoacan
CP 04000, Mexico DF
+52 55 49 16 92 45
info@lightnet.mx
lightnet.mx

lightnet.de